

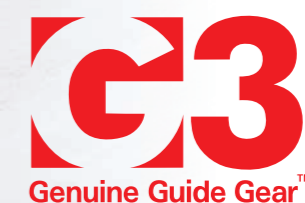

POWDER MASTER

2023-2024 Workbook

BACK COUNTRY SKI &
SNOWBOARD GEARS & WEARS





R·M·U

MTN CULTURE

FW23/24



CONTENTS

WHO WE ARE

RMU is an employee-owned company that practices sustainable innovation while maximizing opportunities for outdoor endeavors through creation of thoughtful, inventive and authentic adventure products.

WHAT WE DO

We are skiers and mountain bikers that embrace the culture of living in the mountains. The RMU Lifestyle was created from adventures and experiences that lead to unique designs and products born from the journey. We build to exceed our own expectations, and stand by our quality.

PRODUCTS

We've been working on some new products for year-round adventures. Take a look at the latest and greatest for Skiing, Mountain Biking and all outdoor products.

SOFT GOODS AND ACCESSORIES

We've been working on some new soft goods and accessories to add to our Spring and Summer line.

PRODUCT OVERVIEW



WE ARE SKIERS
 WE ARE MOUNTAIN BIKERS
 WE ARE A MOUNTAIN CULTURE COMPANY



Our goal from the beginning as skiers was to simply understand more about the industry, ski development and design, and product knowledge to create the best possible products that we would want to use ourselves.

We began researching the process of ski development with the same passion that we had previously brought to the table with researching new lines to ski, snow conditions, and weather patterns.

We'd love to tell you that our skis were amazing from the first pair off the press, but this couldn't be farther from the truth. We were not even able to ski on the first pair we ever pressed! The flex was off, the shape was asymmetrical, and we didn't have enough fiberglass in the ski to retain the bindings. Finally a challenge we were looking for which gave us a starting point! We picked up some old wood charts, reworked our flex patterns, and built another pair that was actually ski-able this time, or at least it looked like it would ski. This ski had the right amount of binding retention and it even looked like a real ski, minus the wooden sidewalls and cloth graphics. After a week of ski testing this version we were eager to try again and refine our process even better making improvements to the next pair. As long time locals in Summit County it was only a matter of time before word got out and all of our friends wanted to try our ridiculous skis. 15 pairs of skis later we received our first real inquiry about a ski purchase, "Hey, I have been looking for someone to make me a pair of 176 underfoot pure powder sticks and I heard you guys had a press down in your basement."

Not understanding at the time what we were embarking on, we offered to build the pair for 30 beers and the cost of materials. Before we knew it, we had built about 50 pairs of what were slowly starting to become decent skis for friends at a cost of 30 beers to a couple hundred bucks. The word was out in town and if you needed something built go see the Rocky Mountain Guys! The name was given to us because we were pressing skis underground in the Rocky Mountains, not because we has some well thought out business plan and branding.

CORE VALUES





CARBON NEUTRAL 2025

RMU is more than just a mountain culture company, we have a shared vision and passion for the environment and the mountains we love so dearly. We want to create a shared legacy where we protect and nurture the natural environment for many years to come.

With this in mind, RMU created a 'Carbon Neutral 2025' pledge to our customer base and all our stakeholders. We ratified this pledge with a signed document outlining the climate goals we will strive to meet over the next 5 years. We aim to be totally carbon neutral come 2025, if not sooner.

Carbon Neutral | Our ski factory has concluded that our skis, through physical materials and manufacturing processes reliant on renewable energy, produce 30.6Kg of CO2 per pair with mixed electricity usage, 28.8Kg when 100% renewable sourced. We are also aiming to reduce plastic materials in shipments & packaging and research into Biobased resins.

We've split out our carbon neutral objectives into 4 main focus areas:

- 1. CARBON NEUTRALITY
- 2. PLASTIC FREE/ZERO WASTE
- 3. LOCALLY SOURCED
- 4. EMPLOYEE/STAKEHOLDER INITIATIVES



We are proud to offer a 95% recycled line of equipment for mountain biking and skiing. By utilizing recycled fabrics, we are up cycling waste into new products. The liner fabric is a recycled 200D Nylon, and the face fabric is a recycled 420D Nylon...Recycled nylon webbing and even a smaller hang tag, help reduce our carbon footprint producing these packs.



SKIS



APOSTLE SERIES

ALL MOUNTAIN





APOSTLE 96

APOSTLE 96

Built for those who are looking for a versatile and playful ski that excels on hard pack and groomers, but can adapt for softer and chunky conditions as well. This ski has a poplar wood core, ABS sidewalls and ABS tip spacers that gives this ski a smooth and torsional flex. The early rise in the tip improves floatation and allows the ski to get on edge with ease! Finally the ABS tail protector, protects your tails when you're standing in the gondola lines or walking through the parking lot.

FEATURES

- 96 mm waist with low rise rocker tip and tail
- Pre-preg fiberglass layup offers lightweight, torsional stiffness and a balanced flex.
- ABS tip and tail spacers
- Poplar wood core
- Beech wood binding mounting plate
- 8.5 mm ABS sidewalls
- ABS tail protector
- Optimal use: 30% soft snow, 70% hard snow
- Handmade in Sweden

184 cm 110-134-96-120-112 mm R 18.5 m

176 cm 109-133-96-118-105 mm R 18.5 m



APOSTLE 96

APOSTLE 96 PRO

New for 23/24 the Apostle 96 Pro is the narrow waisted charger you've been waiting for from RMU. This ski has a poplar wood core, CNC'd Titanal stringers that are tapered to reduce weight, but maintain supreme dampness and optimism stiffness. This development has emphasized the playful nature of our wood construction, while retaining the serious charging attitude of a metal ski. The early rise in the tip improves floatation and allows the ski to get on edge with ease!

FEATURES

- 96 mm waist with low rise rocker tip and tail
- Pre-preg fiberglass layup offers lightweight, torsional stiffness and a balanced flex.
- Two sheets of tapered Titanal on top and bottom of the wood core for added torsional stiffness and chargeability.
- ABS tip and tail spacers
- Poplar wood core
- Beech wood binding mounting plate
- 8.5 mm ABS sidewalls
- ABS tail protector
- Optimal use: 30% soft snow, 70% hard snow
- Handmade in Sweden

184 cm 110-134-96-120-112 mm R 18.5 m

176 cm 109-133-96-118-105 mm R 18.5 m



APOSTLE 96 CARBON TOUR

The perfect backcountry ski for those who require a lighter, but stable ski for technical terrain. The pre-preg carbon fiber and fiberglass layup is combined with a poplar/paulownia wood core and ABS sidewalls. The rubber VDS maintains a smooth flex, torsional flex and playfulness similar to our wood core skis, but in a lighter carbon package. Low rise rocker in the tip improves floatation and allows the ski to get on edge with ease and an ABS tail protector that protects and has an integrated skin-clip to keep your skins secure while on the climb.

FEATURES

- 96 mm waist with low rise rocker tip and tail
- Pre-preg carbon fiber and fiberglass layup offers improved dampness, torsional stiffness and balanced flex
- Full wrap VDS rubber for superior dampening
- Poplar and paulownia wood core
- Beech wood binding mounting plate
- 8.5 mm ABS sidewalls
- ABS tail protector with integrated skin-clip
- Optimal use: 30% soft snow, 70% hard snow
- Handmade in Sweden

184 cm 110-134-96-120-112 mm R 18.5 m
 176 cm 109-133-96-118-105 mm R 18.5 m



APOSTLE 106

Arguably our most popular ski, the Apostle 106 has been long standing in the RMU lineup, dating back to 2011 where the first version of this ski won the best in show at ISPO. The 106 wood construction is our most versatile and intuitive all mountain ski with its lightweight construction and quick maneuverability. The rocketed nose and semi-flat tail creates a strong versatile profile that enables the ski to excel in any condition.

“It’s a ski that’s very, very easy to ski in pretty much all conditions and terrain, yet it’s still fun to carve and can be a blast if you’re someone who likes to ski with a dynamic style - making lots of quick turns and slashes, getting in the airs often, and keeping things a little loose.” -Blister

FEATURES

- 106 mm waist with low rise rocker tip and tail
- Pre-preg fiberglass layup offers lightweight, torsional stiffness and a balanced flex.
- ABS tip and tail spacers
- Poplar wood core
- Beech wood binding mounting plate
- 8.5 mm ABS sidewalls
- ABS tail protector
- Optimal use: 50% soft snow, 50% hard snow
- Handmade in Sweden

192 cm 115-142-106-129-115mm R 20 m
 184 cm 113-140-106-127-115mm R 20 m
 176 cm 113-139-106-126-115mm R 20 m



APOSTLE 106

APOSTLE 106 PRO

This strong and aggressive variation to our most popular ski enables you to charge harder and go bigger. Sought after by those who love a rock solid edge in turns or jumping off massive cliffs at your local resort! We CNC our titanal sheets into 70mm stringers to reduce weight, but maintain supreme dampness and optimism stiffness. This development has emphasized the playful nature of our wood construction, while retaining the serious charging attitude of a metal ski.

FEATURES

- 106 mm waist with low rise rocker tip and tail
- Pre-preg fiberglass layup.
- 70mm sheets of Titanal on top and bottom of the wood core for added torsional stiffness and chargeability.
- ABS tip and tail spacers
- Poplar wood core
- Beech wood binding mounting plate
- 8.5 mm ABS sidewalls
- ABS tail protector
- Optimal use: 50% soft snow, 50% hard snow
- Handmade in Sweden

192 cm 115-142-106-129-115mm R 20 m

184 cm 113-140-106-127-115mm R 20 m

176 cm 113-139-106-126-115mm R 20 m

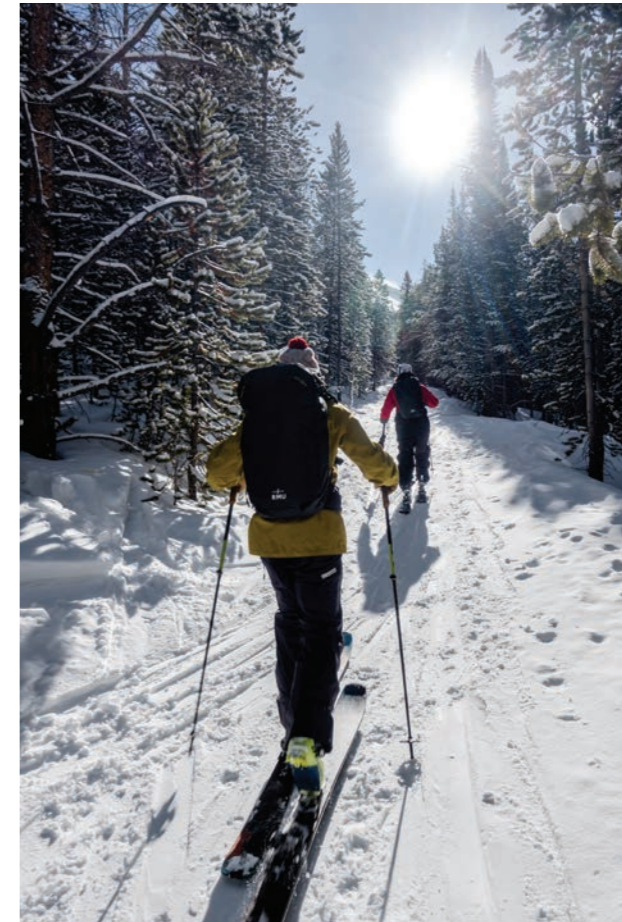

APOSTLE 106 CARBON TOUR

This lightweight all mountain ski is your go too for long uphill ascents and steep downhill terrain. The 106 carbon fiber design is combined with a poplar/paulownia wood core with ABS Sidewalls to maintain the smooth and torsional flex that provides a playful ski great for all conditions. Just like the 96, the Apostle 106 also has low rise rocker in the tip that improves floatation and allows the ski to get on edge. Additionally the ABS tail protector has an integrated skin-clip to keep your skins secure and protect your ski.

FEATURES

- 106 mm waist with low rise rocker tip and tail
- Pre-preg carbon fiber and fiberglass layup offers improved dampness, torsional stiffness and balanced flex
- Full wrap VDS rubber for superior dampening
- Poplar and paulownia wood core
- Beech wood binding mounting plate
- 8.5 mm ABS sidewalls
- ABS tail protector with integrated skin-clip
- Optimal use: 50% soft snow, 50% hard snow
- Handmade in Sweden

192 cm 115-142-106-129-115mm R 20 m
 184 cm 113-140-106-127-115mm R 20 m
 176 cm 113-139-106-126-115mm R 20 m

VALHALLA SERIES

ALL MOUNTAIN





VALHALLA 97

The Valhalla has been in the RMU lineup for many years and for good reason. Designed with Keri Herman and other industry professionals, they wanted a strong and versatile all mountain ski that could combat everything in sight. A rock solid ski that can be used in the terrain park or with professional backcountry guides, its tapered sidecut creates a nimble ski in tight terrain, while ramping up a strong progressive flex pattern for alpine riding.

“Here’s a ski designed not just for women, but also by women, including Olympic Freeskier Keri Herman. The union loved this ski in soft, open steeps, where it floats like a dream and cruises through mixed snow conditions in the apron”

-Powder Magazine

FEATURES

- 97 mm waist with low rise rocker tip and tail
- Pre-preg fiberglass layup offers lightweight, torsional stiffness and a balanced flex.
- ABS tip and tail spacers
- Poplar wood core
- Beech wood binding mounting plate
- 8.5 mm ABS sidewalls
- ABS tail protector
- Optimal use: 30% soft snow, 70% hard snow
- Handmade in Sweden

162 cm 95-125-97-119-93 mm R 17 m

172 cm 92-126-97-120-93 mm R 17 m



VALHALLA 107

Keri Herman worked with 25 other women in our home os Summit County, CO to build the most versatile and playful ski for them. This ski has won multiple awards and regarded as one of our best skis to date. Ridden by men and women alike from the park to backcountry adventures, it's built for intermediate to advanced skiers that love all types of terrain. It has a partial twin tip with a pin sidecut, that gives it quick maneuverability and a sold feel with the rocker, camber, rocker profile.

“The Valhalla is so poppy, playful, whippy, turny, spinny, buttery and amazing”
-Keri Herman

FEATURES

- 107 mm waist with low rise rocker tip and tail
- Pre-preg fiberglass layup offers lightweight, torsional stiffness and a balanced flex.
- ABS tip and tail spacers
- Poplar wood core
- Beech wood binding mounting plate
- 8.5 mm ABS sidewalls
- ABS tail protector
- Optimal use: 50% soft snow, 50% hard snow
- Handmade in Sweden

162 cm 101-135-107-124-94mm R 18.5 m
172 cm 101-134-107-123-94 mm R 18.5 m



VALHALLA 107

VALHALLA 107 CARBON TOUR

With similar characteristics as our wood Valhalla, the carbon ski uses aerospace carbon and lighter fiberglass allowing us to create an extremely playful, damp, lightweight ski. Whether you are looking for uphill performance or a fun poppy downhill ski, our carbon construction is versatile for every rider. The 107 waist width is perfect for the deeper days or uphill adventures and the tail clip for attaching skins is an added bonus.

FEATURES

- 107 mm waist with low rise rocker tip and tail
- Pre-preg carbon fiber and fiberglass layup offers improved dampness, torsional stiffness and balanced flex
- Full wrap VDS rubber for superior dampening
- Poplar and paulownia wood core
- Beech wood binding mounting plate
- 8.5 mm ABS sidewalls
- ABS tail protector with integrated skin-clip
- Optimal use: 50% soft snow, 50% hard snow
- Handmade in Sweden

162 cm 101-135-107-124-94mm R 18.5 m
 172 cm 101-134-107-123-94 mm R 18.5 m

NORTH SHORE SERIES

BIG MOUNTAIN



NORTH SHORE 114

This long awaited big mountain ski is the big brother to the Apostle 3.0. Developed with RMU athlete Alex Armstrong, we wanted to create a big mountain freeride ski that could also be used on the alpine. Inspired by her racing roots and freeride style, they run stable at high speeds and maintain maneuverability to nail technical lines and slash a good old-fashioned pow turn. We compiled the playful and strong characteristics of the Apostle in an aggressive big mountain free ride attitude by using an extended sidecut for longer effective edge and stability at speed. We also increased the rocker for deep conditions and stiffed the flex pattern for aggressive riding.

“The NS114 is my go to ski for anything from bottomless pow to pillow stacks, to big mountain lines.” - Alex Armstrong.

FEATURES

- 114 mm waist with low rise rocker tip and tail
- Pre-preg fiberglass layup offers lightweight, torsional stiffness and a balanced flex.
- ABS tip and tail spacers
- Poplar wood core
- Beech wood binding mounting plate
- 8.5 mm ABS sidewalls
- ABS tail protector
- Optimal use: 70% soft snow, 30% hard snow
- Handmade in Sweden

192 cm 120-147-114-133-121mm R 22 m
 184 cm 119-143-114-131-120mm R 22 m
 176 cm 119-143-114-131-120mm R 22 m

NORTH SHORE 114



NORTH SHORE 114

NORTH SHORE 114 CARBON TOUR

The 114 Carbon drops 500g. / 13% of weight per pair compared to the wood construction model. The incorporation of carbon improves responsiveness and control underfoot, while including rubber dampening in the tip and tail that significantly reduces chatter. The softer flex pattern allows for a playful style in your backcountry adventures and is much lighter on the uphill!

FEATURES

- 114 mm waist with low rise rocker tip and tail
- Pre-preg carbon fiber and fiberglass layup offers improved dampness, torsional stiffness and balanced flex
- Full wrap VDS rubber for superior dampening
- Poplar and paulownia wood core
- Beech wood binding mounting plate
- 8.5 mm ABS sidewalls
- ABS tail protector with integrated skin-clip
- Optimal use: 70% soft snow, 30% hard snow
- Handmade in Sweden

192 cm 120-147-114-133-121mm R 22 m
 184 cm 119-143-114-131-120mm R 22 m
 176 cm 119-143-114-131-120mm R 22 m



NORTH SHORE YLE 110

This playful and maneuverable ski excels in big mountain, but is playful enough to charge in the park. It's fun surfy feel lets you slash the powder and charge through the crud. The light weight poplar wood core allows the silky smooth feel with the pop desired for hucking cliffs and jumps. It's a favorite within the RMU Athletes and it won't let you down!

FEATURES

- 110 mm waist with low rise rocker tip and tail
- Pre-preg fiberglass layup offers lightweight, torsional stiffness and a balanced flex.
- ABS tip and tail spacers
- Poplar wood core
- Beech wood binding mounting plate
- 8.5 mm ABS sidewalls
- ABS tail protector
- Optimal use: 50% soft snow, 50% hard snow
- Handmade in Sweden

184 cm 110-134-96-120-112 mm R 18.5 m

176 cm 109-133-96-118-105 mm R 18.5 m

PROFESSOR SERIES

ALL MOUNTAIN FREESTYLE





PROFESSOR 121

This is the perfect ski for those who want to jump, jib and slash their way all over the mountain. The classic freestyle rocker profile provides ample comfort for spins or sketchy lines and can still get on edge with ease when getting back to the chairlift or snowmobile. The versatility spreads from slashing powder, bombing cliffs, plowing through pillows and spinning off any feature in sight. RMU athlete Benny Smith helped design the Professor and RMU Athlete Mark Abma uses as his daily driver. Class is now in session and the Professor has arrived!

FEATURES

- 121 mm waist with low rise rocker tip and tail
- Pre-preg fiberglass layup offers lightweight, torsional stiffness and a balanced flex.
- ABS tip and tail spacers
- Poplar wood core
- Beech wood binding mounting plate
- 8.5 mm ABS sidewalls
- ABS tail protector
- Optimal use: 80% soft snow, 20% hard snow
- Handmade in Sweden

188 cm 126-147-121-140-119 mm R 21 m

178 cm 126-147-121-139-119 mm R 21 m

BENCHMARK SERIES

THE OUTLIERS



BUTTERKNIFE

Drawing from RMU's drive to push ski innovation into the future, Wiley Miller challenged us to create a new ski specifically for low speed and low angle powder conditions. Thus creating the Butterknife. During big pow days mid season, when bigger lines are too dangerous to ski, we are all in pursuit of safe snow. The Butterknife was shaped with the ethos of swallow tail fish surfboards and snowboards to make skiing in powder effortless, surfy and playful at lower speeds. A longer low rise rocker mixed with its unique shape provides a lower speed float. The Butterknife's directional surf shape and full width swallow tail allows snow to release easily off the tail and provide a super surfy feel.

FEATURES

- 126-mm waist with longer low rise rocker tip and low rise tail
- Surf inspired asymmetrical shape
- Pre-preg fiberglass layup offers lightweight, torsional stiffness and a balanced flex
- ABS tip and tail spacers
- Poplar wood core
- Beech wood binding mounting plate
- 8.5 mm ABS sidewalls
- ABS tail protector
- Optimal use: 90% soft snow, 10% hard snow
- Handmade in Sweden

176 cm 157-126-134 mm R 25 m outside 17 m inside



RIPPAH

A core freestyle ski, from its construction to its shape, the Rippah embodies an instrument designed for creative expression. A lightweight poplar core provides the platform for low swing-weight and playfulness. Responsive flex while burly construction holds up to over-flexing, hitting rails and the occasional concrete wall ride.

FEATURES

- 98 mm waist with low rise rocker tip and tail
- Pre-preg fiberglass layup offers lightweight, torsional stiffness and a balanced flex.
- 1/2 cap construction
- ABS tip and tail spacers
- Poplar wood core
- Beech wood binding mounting plate
- 8.5 mm ABS sidewalls
- ABS tail protector
- Optimal use: 30% soft snow, 70% hard snow
- Handmade in Sweden

184 cm 110-134-96-120-112 mm R 18.5 m
 176 cm 109-133-96-118-105 mm R 18.5 m



RIPPAH JR

As a Mountain Culture company, we aim to share the love of mountains. To do so we must include gear for everyone, so it's about time we release a junior ski. To all the young rippers getting after it and the few that just need something shorter, this is for you. The Rippah Jr incorporates a smooth and dynamic flex pattern, helping balance between a peak performance and playful ski. Coupled with a playful rocker profile that encourages mastering new tricks, turns, jumps and slopes. So whether it's a grom in the park, a ripper on the groomer, a powder hound, or a back-country adventurer, it's for all junior skiers.

FEATURES

- 90-92 mm waist with low rise rocker tip and tail
- Pre-preg fiberglass layup offers lightweight, torsional stiffness and a balanced flex.
- ABS tip and tail spacers
- Poplar wood core
- 8.5 mm ABS sidewalls
- ABS tail protector
- Optimal use: 50% soft snow, 50% hard snow
- Handmade in Sweden

152 cm 123-90-111 mm R 12.5 m
 162 cm 127-92-115 mm R 13.5 m

EQUIPMENT



♻️ CORE PACK 25L



CORE PACK 25L

The New Core Pack 25 is our most technical daypack yet. From experimentation and learning from our Core pack 35 adventure pack, we have now designed this ski touring and mountaineering specific pack. Prioritizing necessary features with easily accessible and organized storage for no wasted potential.

FEATURES

- 25L capacity
- Recycled 420d nylon fabric with a carbonate & PU coating
- tool organization fits a bladder, tools, extra jacket, and first aid kit
- integrated moldable backpanel
- Top load and back panel access
- RMU signature CNC buckles & hardware
- Two fleece-lined pockets brings scratch-free protection for goggles, glasses, phones or cameras
- Diagonal and a-frame ski carry
- Waterproof skin pocket with integrated helmet sling
- 3 LBS

CORE PACK 42L

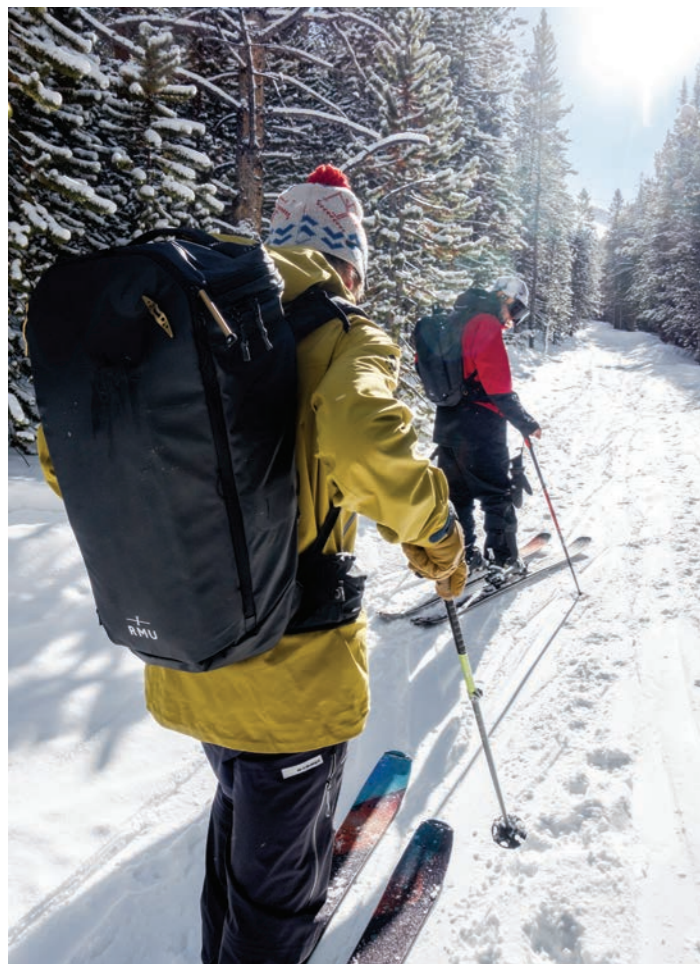

CORE PACK 42L

Introducing the new Core Pack 42L. Whether you're setting out on a hut trip, or mountaineering trip and need room for all of the gear, extra layers, nutrition with you. The 42L has dedicated pockets, compartments and carrying options for all of your necessary gear, keeping everything organized and ready to go at a moments notice. In addition to the multiple ski carry options, easy-access avy tool pocket, and dedicated waterproof skin pocket, and helmet sling, you have tons of options to carry all the gear you need and more for any adventure.

FEATURES

- 42l capacity
- Recycled 420d nylon fabric with a carbonate & PU coating
- tool organization fits a bladder, tools, extra jacket, and first aid kit.
- integrated moldable backpanel.
- top load and back pannel access.
- RMU signature CNC buckles & hardware
- Two fleece-lined pocket brings scratch-free protection for goggles, glasses, phones or cameras
- Diagonal and A-frame ski carry.
- waterproof skin pocket with integrated helmet sling
- Rope and ice axe carry
- 4 LBS

CORE PACK 15L



CORE PACK 15L

Newly redesigned for 2022! A quiver killer pack designed for Every Season. From mountain biking in Whistler to skiing in the Rockies, the Core Pack 15L does it all. Innovative features and best-in-class quality deliver the ultimate do-everything pack.

FEATURES

- Recycled 420d nylon fabric with a carbonate & PU coating
- Reinforced tool organization fits a bladder, tools, extra jacket, and first aid kit.
- Aluminum perimeter frame
- RMU signature CNC buckles & hardware
- Breathable vest-style harness securely carries any load.
- Laptop compartment for work on the road.
- Removable RMU signature Utility Belt for shorter rides and easy carry while traveling light.
- Fleece-lined pocket brings scratch-free protection for goggles, glasses, phones or cameras
- Diagonal ski carry
- 2.5 LBS

POWDER MASTER

強風や降雪時においても、素早く、簡単にクライミングスキンを収納および貼りつけができるスキン用簡易収納袋です。イージースキンセーバーはスキンの接着面に雪がつきにくく、スキンの接着剤に適合した特殊素材を使用していますので、取り扱いがとてシンプルになります。



EASY SKIN SAVER

イージースキンセーバー
7900055-190 (ブラック)
7900055-220 (レッド)
7900055-554 (ライムグリーン)
¥2,750 (税抜¥2,500)

サイズ:58×17cm
重量:50g/ペア
*シーズンオフに長期保管する場合はスキンガードフィルムを使用してください。
*130mm以上のスキンにはファットタイプをお薦めします。
*生地はストレッチ仕様です。

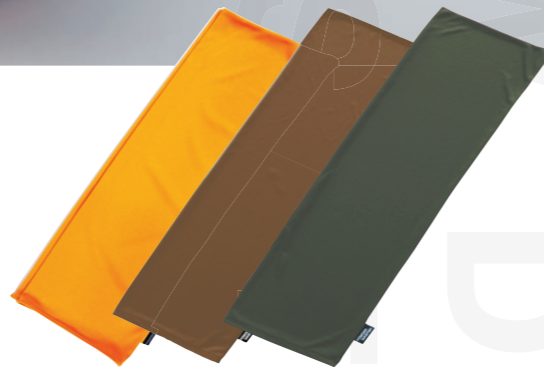

EASY SKIN SAVER FAT

イージースキンセーバー ファット
7900056-335 (オレンジ)
7900056-440 (ブラウン)
7900056-566 (ダークオリーブ)
¥2,970 (税抜¥2,700)
重量:75g/ペア

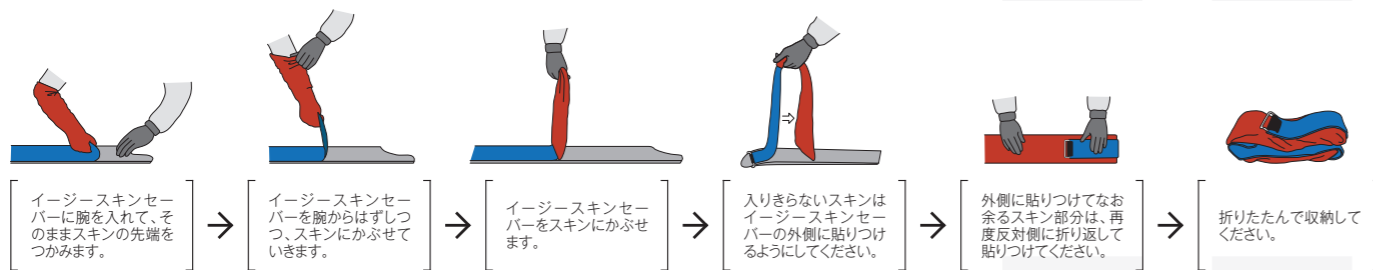

THE PERFORMANCE LEADER
IN TELEMARK BINDINGS

2023/24

TWENTYTWODESIGNS.COM



OUTLAW X

OUTLAW X アウトロー X

ステップイン&アウトしやすく、軽量で耐久性に優れたアウトローX。素晴らしいダウンヒル性能とAXLで実証されたツアー性能を備えています。さらに、完全なステップインと、スキーボールを使用して押すことによるリリースが可能。足元の金属プレートは横方向の剛性を損なうことなくスムーズなフレックスを実現しています。金属プレートの下に内蔵されたシングルラージスプリングを回すことにより、好みの硬さに容易に強弱調整が可能です。2019-20モデルからダブルアップヒール採用となりました。

*OUTLAWとLINXはNTNブーツサイズS、Lに準じます。スカルパは26.0までがS、それ以上はL。スコットは25.5までがS、それ以上がLです。



7901300
¥61,600 (税抜¥56,000)
サイズ:NTN規格S、L
重量:1.520g (Sペア、ヒールパーツ含む)
1.590g (Lペア、ヒールパーツ含む)

LYNX

LYNX リンクス

NTN-TECH-TOEを採用したツアーリングビンディングです。頑丈なアルミニウムパーツを採用。簡単な操作でスキー&ウォークモードの切り替えができます。フレックスプレート、ビンディング動作部分の調整ができ、かつてない軽量性と耐久性を持ち合わせた新しいデザインに仕上がっており、軽量なスプリングを搭載するなど、まさに「ライトツアーリング テレマークビンディング」のニュースタンダードと言えるでしょう。

7901120
¥75,900 (税抜¥69,000)
サイズ:NTN規格S、L
重量:960g (Sペア)
1,000g (Lペア)

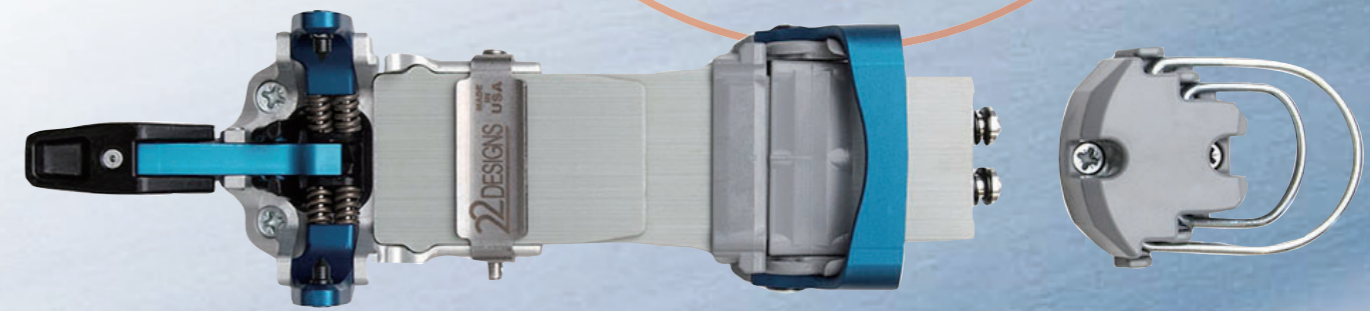

LYNX クランボン
90mm:7901123 ¥13,750 (税抜¥12,500)
95mm:7901124 ¥14,300 (税抜¥13,000)
102mm:7901125 ¥14,850 (税抜¥13,500)
110mm:7901126 ¥15,950 (税抜¥14,500)
115mm:7901127 ¥16,500 (税抜¥15,000)
120mm:7901128 ¥17,050 (税抜¥15,500)



OUTLAW ブレーキ (ペア)
95mm、110mm、125mm:
7900110
¥6,160 (税抜¥5,600)



OUTLAW スティッフスプリング (ペア)
7900198 ¥3,850 (税抜¥3,500)
サイズ:S用、L用



OUTLAW スプリングキャップ (シングル)
7900108 ¥1,100 (税抜¥1,000)



OUTLAW/AXL
プラスチックベース
7900116
¥1,100 (税抜¥1,000)



OUTLAW クランボン
90mm:7901109 ¥16,500 (税抜¥15,000)
95mm:7901110 ¥17,050 (税抜¥15,500)
102mm:7901111 ¥17,600 (税抜¥16,000)
110mm:7901112 ¥18,150 (税抜¥16,500)
115mm:7901113 ¥18,700 (税抜¥17,000)
110mm:7901112 ¥19,250 (税抜¥17,500)

OUTLAW クランボン マウントブロック
7901115 ¥6,600 (税抜¥6,000) 125mm



OUTLAW/LYNX
スリックピン (シングル)
7900128 ¥660 (税抜¥600)



OUTLAW アジャスター/
ボトルオープナー
7900106 ¥2,200 (税抜¥2,000)



OUTLAW フレックスプレート (シングル)
7900109 ¥3,520 (税抜¥3,200)
サイズ:S用、L用

OUTLAW アンチアイステープ (ペア)
7900114 ¥550 (税抜¥500)

アウトローのステップインをする時のカムを可動しやすくするための予備テープ。



OUTLAW/AXL
ベースインサート
7900117
¥550 (税抜¥500)



OUTLAW/AXL/VICE/LYNX
22Dプレート付ユニバーサルジグ
7901311
¥61,600 (税抜¥56,000)

roXboジグ22Dプレート
7901312
¥14,300 (税抜¥13,000)



コイルリーシュ (ペア)
7901304
¥3,850 (税抜¥3,500)

22D ロゴ
スキーストラップ
7901121 ¥1,320 (税抜¥1,200)
サイズ:38cm

Schwag
22D Logo Tshirt
7901323
¥3,850 (税抜¥3,500)
サイズ:S、M、L、XL

All for the Turn' Tshirt
7901324
¥3,850 (税抜¥3,500)
サイズ:S、M、L、XL
Women's Tshirt
7901325
¥3,850 (税抜¥3,500)
サイズ:S、M、L、XL

テールリーシュ (ペア)
7900153
¥2,310 (税抜¥2,100)
テールスローにクリップしてブーツの足首に回し、バックルで簡単にセットできます。確実にセットしておけばテールスローが外れる危険がありません。



ユニバーサル
バックカントリー
リペアキット
7900183 ¥4,180 (税抜¥3,800)



All for the Turn' Zip Hoody
7901322 ¥7,150 (税抜¥6,500)
サイズ:S、M、L、XL



*デザイン、カラーは変更になる場合があります。



OUTLAW/AXL
ダブルアップヒール (ペア)
台座32mm
7901302
¥4,400 (税抜¥4,000)



LYNX
ダブルアップヒール (ペア)
台座25mm
7901303
¥4,400 (税抜¥4,000)

Driggs' Buff
7901326
¥3,080 (税抜¥2,800)



22D
ロゴパッチ
7900107
¥1,760
(税抜¥1,600)



Logo Trucker Hat
7901327
¥4,180 (税抜¥3,800)

AXL



AXL アクセル

頑強なスチール一体型フロントピースは立ち上がりが高めで長く、サイド方向へのプレをなくし板へのしっかりとしたパワー伝達を実現しています。足裏に配置されたスプリングと稼働するキノコ型樹脂プレートがテレマークスタイルに必要な絶妙なねじれフレックス感と押し付け感を与えてくれます。壊れ知らずでピボットポイントを変更できあらゆるテレマークカーの好みに合わせてカスタマイズできます。AXL最高! 2019-20モデルは、ダブルアップヒール採用となります。

7901301
¥61,600 (税抜¥56,000)
サイズ=S (フーツサイズ25.5cm以下)
L (フーツサイズ26.0cm以上)
重量: 1814g (ペア、ヒールパーツ含む)

AXL クランボン

90mm: 7901101 ¥15,400 (税抜¥14,000)
95mm: 7901102 ¥15,950 (税抜¥14,500)
102mm: 7901103 ¥16,500 (税抜¥15,000)
110mm: 7901104 ¥17,050 (税抜¥15,500)
115mm: 7901105 ¥17,600 (税抜¥16,000)
120mm: 7901106 ¥18,150 (税抜¥16,500)



VICE



VICE ヴァイス

高い評価を得ているアクセルを改良し、ウォークモードを取り外しシンプルにしたピステスキータイプです。ピボットポイントを3か所に変更可能で、スキースタイルやスノーコンディションに合わせてセッティングしてください。ハンマーヘッド好きなライダーには、ヴァイスもお気に入りのピンディングになるでしょう。

7900139
¥46,200 (税抜¥42,000)
サイズ=S (フーツサイズ25.5cm以下)
L (フーツサイズ26.0cm以上)
重量: 1450g (ペア)

VICEソフトスプリング仕様

7901313
¥39,600 (税抜¥36,000)
サイズ=S (フーツサイズ25.5cm以下)
ソフトスプリング仕様
ソフトな足上げ感を好む人向け

AXL クランボン マウントブロック 7901107 ¥6,600 (税抜¥6,000)
AXL クランボン ポストセット (ペア) 7900126 ¥3,300 (税抜¥3,000)

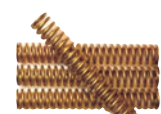
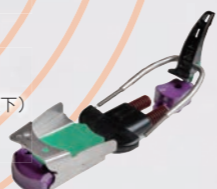
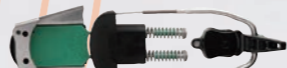

AXL&VICE
スティッフキット ラージ用
7900184
¥5,170 (税抜¥4,700)
標準装備のスプリングより15%硬い。

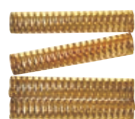

AXL&VICE
ソフトキット スモール用
7900141
¥5,170 (税抜¥4,700)
標準装備のスプリングより15%軟らかい。



AXL ヒールベール
トールペア
7900177
¥2,200 (税抜¥2,000)
ワイヤー高83mm



AXL ヒールベール
ショートペア
7900157
¥1,980 (税抜¥1,800)
ワイヤー高59mm



AXL ヒールベール
スタンダード シングル
7900133
¥660 (税抜¥600)

VICE ヒール
ベール無し(シングル)
7900137
¥1,320 (税抜¥1,200)

AXL & VICE
カートリッジインサート
7900132
¥440 (税抜¥400)

AXL
フレックスプレート(シングル)
7900127
¥1,100 (税抜¥1,000)
カラー: レッド、グリーン



AXL&VICE
リアケーブル
7900148
¥3,080
(税抜¥2,800)
サイズ=S、L



AXL&VICE
ヒールチューブS
7900129
¥4,180 (税抜¥3,800)
AXL&VICE
ヒールチューブL
7900130
¥4,180 (税抜¥3,800)

AXL Mt
スクリューバック×16
7900178
¥880 (税抜¥800)

AXL
ピボットスクリュー
7900134
¥110 (税抜¥100)

AXL
スリックピン
(シングル)
7900195
¥1,100 (税抜¥1,000)
ケーブルガイドポジションを変更するためのピン



AXL テールスロー シングル
7900190 ¥1,32 (税抜¥1,200)



VICE テールスロー シングル
7900149 ¥1,320 (税抜¥1,200)

G3



Marty Lazarski
pc: Reuben Krabbe

**2023
2024**
WORKBOOK

R3

**ALL G3 SKIS ARE NOW
100% RECYCLABLE**





R3

RECYCLABLE SKIS



R3 RIDE. REPEAT. RECYCLE.

Finally, an ultra high performance ski that is fully recyclable with no compromises in flex, weight, or durability. G3's proprietary R3 recycling process means you can be confident all the materials will be recaptured, repurposed, or recycled after you retire your skis.

HERE'S HOW IT WORKS:

- 1** Ski the heck out of the new R3 skis. Push them hard to get full use from them. They are made with the same premium materials you have come to expect from G3 (carbon, PU, magnetic, etc.) allowing for peak performance in the most demanding environments.
- 2** Ready to move on to another ski, but they still have some life? Pass them on to someone else as it will extend the useful life even further. These skis are built to last and will facilitate some of the best experiences you will ever have on snow.
- 3** When the skis have finally reached the end of their life, send them back to G3. Our team separates each component using G3's proprietary eco-friendly materials and systems. We are left with the original ski materials to reuse or recycle.

WHAT DO WE DO WITH THE COMPONENTS?

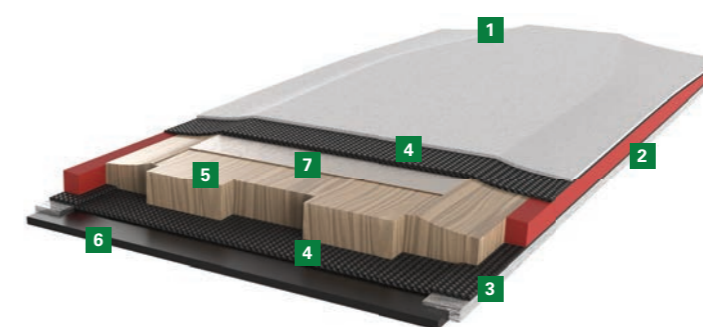

- 1** Nylon topsheet - recycle
- 2** PolyUrethane sidewall & tail protector - recycle
- 3** Steel edges - recycle
- 4** Carbon or glass fibre - reuse
- 5** Wood core - recycle
- 6** HDPE base - recycle
- 7** Titanal aluminum - recycle
- 8** Magnets - reuse
- 9** Resin - reuse





WHY G3? | R3 SKIS

There is a lot of cool technology and engineering that goes into our gear. But the real story behind G3 skis is why we make them in the first place - every decision we make and material we use is designed to make ski touring even better than it already is. We strive for that ideal balance of uphill and downhill performance, and the proof in all of this comes when you get out and just ski 'em.

Now all G3 skis are 100% recyclable.

INTRODUCING G3'S NEW R3 RECYCLABLE SKIS

R3 RIDE. REPEAT. RECYCLE.

Finally, an ultra high performance ski that is fully recyclable with no compromises in flex, weight, or durability. G3's proprietary R3 recycling process means you can be confident all the materials will be recaptured, repurposed, or recycled after you retire your skis.

HERE'S HOW IT WORKS:



- 1 Ski the heck out of the new R3 skis. Push them hard to get full use from them. They are made with the same premium materials you have come to expect from G3 (carbon, PU, magnetic, etc.) allowing for peak performance in the most demanding environments.
- 2 Ready to move on to another ski, but they still have some life? Pass them on to someone else as it will extend the useful life even further. These skis are built to last and will facilitate some of the best experiences you will ever have on snow.
- 3 When the skis have finally reached the end of their life, send them back to G3. Our team separates each component using G3's proprietary eco-friendly materials and systems. We are left with the original ski materials to reuse or recycle.

PREMIUM CARBON FIBRE CONSTRUCTION



G3 uses only premium carbon fibre laminates in the FINDr, SEEKr, and SLAYr skis. These are the same 100% multi-directional stitch bonded fabrics used in aerospace industries. To optimize the flex, rigidity and power transfer specific to each ski, we meticulously engineer every layer of carbon above and below the core.

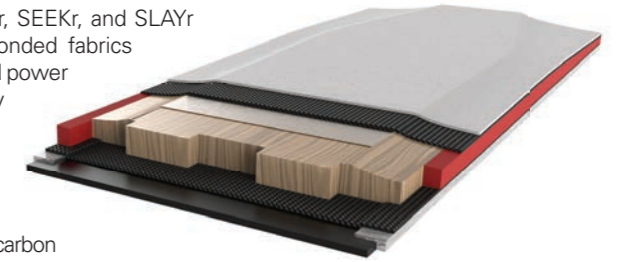

WET VS. DRY LAYUP

G3 starts with dry and flexible sheets of carbon fibre for each ski. This allows us to use exactly the right amount of resin for each ski's size, weight, and the amount of carbon laminate. Our process minimizes unnecessary resin weight and maximizes the carbon's contribution to flex, rigidity and power transfer.

MAGNETIC CONTACT POINTS



Introduced in Fall 2019, the G3 ski line-up is magnetic at both the tip and tail contact points to hold your skis together without a strap for faster transitions and less fiddle. This leads to more efficient technical transitions as well as smoother general movement around the mountain - at the base, in the van or the roof box, and eliminating the scissoring that is so common with Jerrys everywhere. Seriously, get your hands on a pair and try it out.



PU SIDEWALLS IN ALL SKIS

WHAT IS POLYURETHANE?

Polyurethane (or PU) is an elastomeric polymer material known for its energy absorption, durability, and elasticity. It is commonly used in skateboard wheels and racecar bushings to make for a smoother ride.

NO MORE CHATTER

An inherent problem with carbon and ultralight touring skis is chatter, due to the light and stiff materials used. PU sidewalls counteract this chatter by absorbing that extra energy and creating a more damp ride overall.

DURABILITY & VERSATILITY

The elasticity of PU increases durability by 30% improving protection from sidewall impact when compared to ABS. Using PU in ski construction also allows for a permanent bond to the wood core and a seamless sidewall.



GEAR SPECIFICALLY DESIGNED FOR AND TAILORED TO SMALLER BACKCOUNTRY USERS

This is not a "female series," a "youth series," or a "beginner series" SWIFT gear is technical and suitable for any gender. Every detail in this collection of high performance equipment is dialed in for smaller adults and youth looking to push the limits of what they can accomplish in the backcountry.



NEW

FINDr R3



- R3 recyclable keeping the skis out of the landfill
- Polyurethane sidewalls for best-in-class dampness
- Magnetic contact points speed up bootpack transitions and eliminate the need for a strap when shouldering
- Modern ski built for precision in steep and technical terrain
- Uncompromised performance and versatility in all conditions
- Full carbon fibre construction

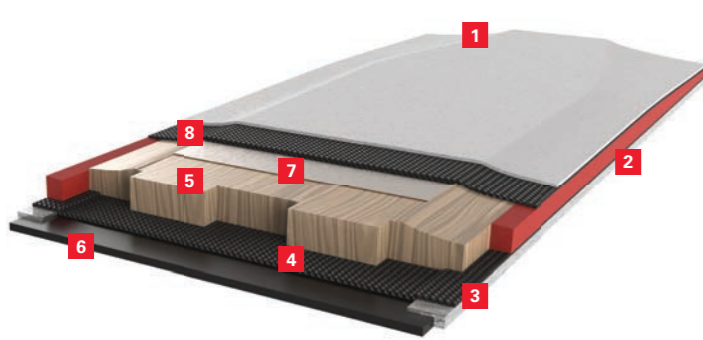

- 1 Super light textured nylon topsheet - durable & sheds snow/ice
- 2 PolyUrethane sidewall - durability & dampness
- 3 Lightweight hardened steel edges - corrosion & dent resistant
- 4 2 layers of carbon fibre, triaxial stitched - strong, light & torsionally stable
- 5 3D shaped Poplar Paulownia wood core - light & high performance
- 6 Full thickness base - durable, long-lasting & fast
- 7 Titanal aluminum mounting plate - mount integrity & dampness
- 8 2 layers of carbon fibre, quadraxial stitched - strong, light & torsionally stable

TRADITIONAL CAMBER WITH EARLY RISE

Built to excel in ski mountaineering applications, hard and mixed snow conditions, and to give maximum edge control, the FINDr features a traditional camber profile. This true alpine touring ski includes an early-rise tip to give additional float in deep snow.

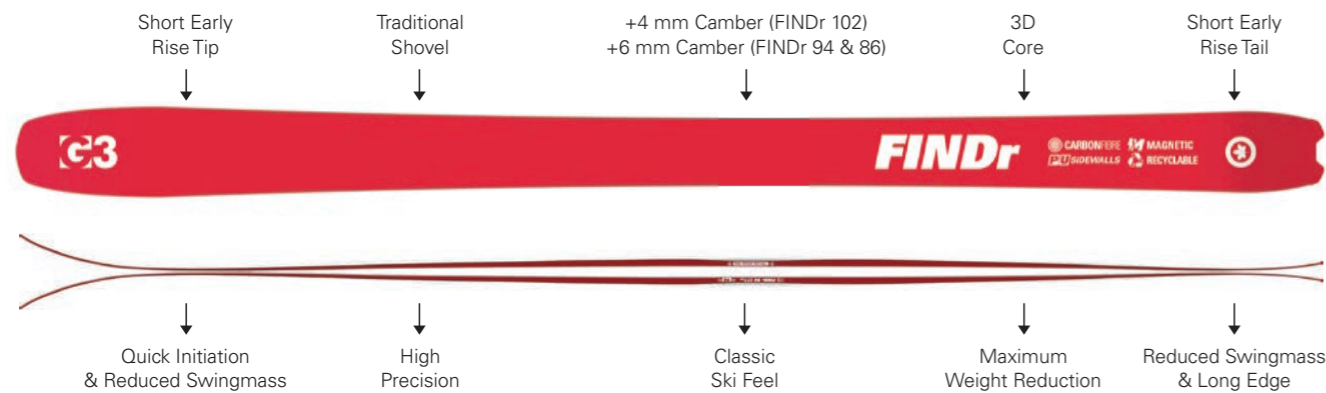

PATENT PENDING
73 POWDER MASTER 2023-2024



FINDr R3 102

This freeride-inspired ski balances weight and edge hold with a damp and powerful ride. The FINDr R3 102 is light but strong and is exceptionally fun to ski anything from soft snow to hardpack conditions.

133 / 102 / 120 mm						
SIZE:	-	-	174 cm	179 cm	184 cm	189 cm
SWIAT	164 cm	169 cm	-	-	-	-
RADIUS:	18.6 m	20.0 m	21.4 m	22.6 m	23.9 m	25.2 m
WEIGHT:	1.33 kg	1.4 kg	1.47 kg	1.52 kg	1.59 kg	1.63 kg
(single)	2 lb 15 oz	3 lb 1 oz	3 lb 4 oz	3 lb 6 oz	3 lb 8 oz	3 lb 9 oz

FINDr R3 94

A modern ski optimized for precision in steep and technical terrain, the FINDr R3 94 excels with its best-in-class dampness and versatility to perform in all backcountry conditions- perfect to tour far and high, and ski hard and fast.

126 / 94 / 113 mm						
SIZE:	-	-	172 cm	177 cm	182 cm	187 cm
SWIAT	154 cm	162 cm	167 cm	-	-	-
RADIUS:	14.7 m	16.7 m	18.0 m	19.4 m	20.7 m	22.2 m
WEIGHT:	1.2 kg	1.27 kg	1.31 kg	1.36 kg	1.41 kg	1.5 kg
(single)	2 lb 10 oz	2 lb 13 oz	2 lb 14 oz	3 lb 0 oz	3 lb 2 oz	3 lb 5 oz

FINDr R3 86

High altitude, long distance objectives, or just lightening the load for a quick early morning skin, the FINDr R3 86 over-performs as a traditional touring ski on the skin up and - just as importantly - the rip down!

122 / 86 / 109 mm						
SIZE:	-	-	172 cm	177 cm	182 cm	
SWIAT	162 cm	167 cm	-	-	-	-
RADIUS:	15.2 m	16.2 m	17.1 m	18.2 m	19.2 m	
WEIGHT:	1.18 kg	1.23 kg	1.3 kg	1.35 kg	1.41 kg	
(single)	2 lb 9 oz	2 lb 11 oz	2 lb 14 oz	3 lb 0 oz	3 lb 2 oz	

NEW

FINDr FLX R3



- R3 recyclable keeping the skis out of the landfill
- Polyurethane sidewalls for best-in-class dampness
- Magnetic contact points speed up bootpack transitions and eliminate the need for a strap when shouldering
- Modern ski built for precision across the mountain
- Ski in & out of bounds with ease
- Glass fibre construction for added dampness on hardpack

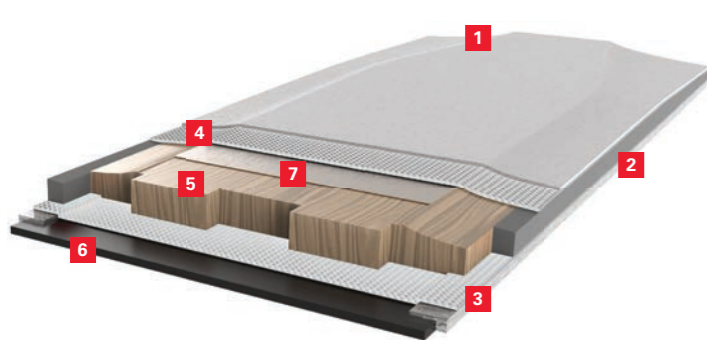

- 1 Super light textured nylon topsheet - durable & sheds snow/ice
- 2 PolyUrethane sidewall - durability & dampness
- 3 Lightweight hardened steel edges - corrosion & dent resistant
- 4 Triaxial glass - torsion, flex & value
- 5 3D shaped Poplar Paulownia wood core - light & high performance
- 6 Full thickness base - durable, long-lasting & fast
- 7 Titanal aluminum mounting plate - mount integrity & dampness

TRADITIONAL CAMBER WITH EARLY RISE

Built to excel in hard and mixed snow conditions and to give maximum edge control, the FINDr FLX features a traditional camber profile. This alpine / touring ski includes an early-rise tip to give additional float in deeper snow.

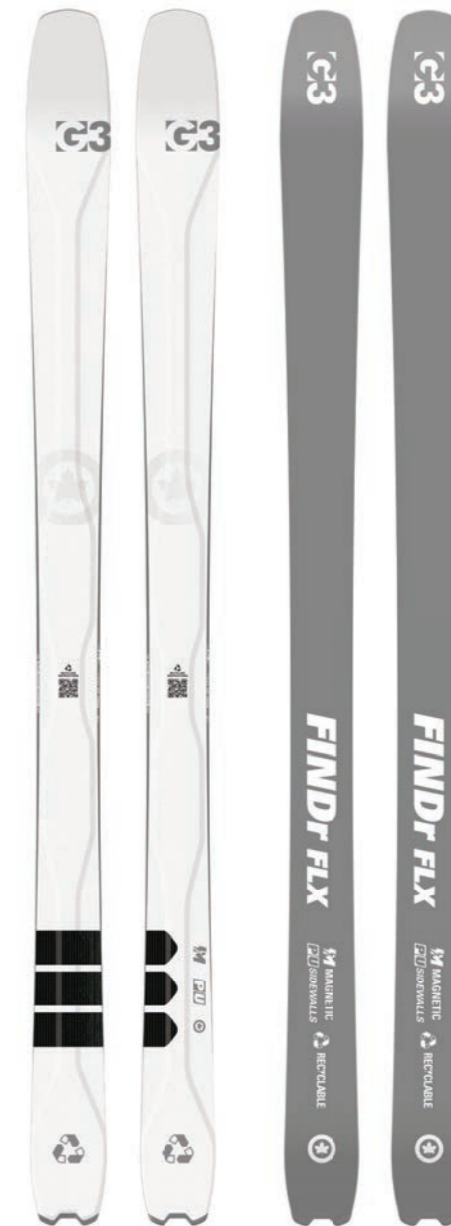
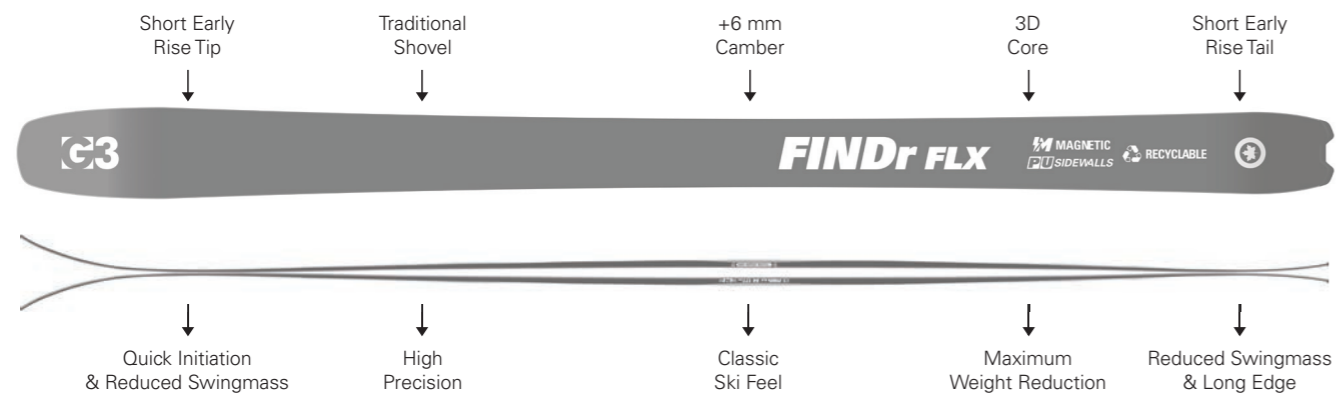

FINDr FLX R3 94

Glass fibre construction and Polyurethane sidewalls transform the beloved FINDr 94 shape to a high performing 50/50 ski for pursuits both in and out of bounds.

126 / 94 / 113 mm

SIZE: 154 cm 162 cm 167 cm 172 cm 177 cm 182 cm 187 cm

RADIUS: 14.7 m 16.7 m 18.0 m 19.4 m 20.7 m 22.2 m 23.7 m

WEIGHT: 132 kg 138 kg 144 kg 149 kg 154 kg 159 kg 164 kg
(single) 2 lb 14 oz 3 lb 1 oz 3 lb 3 oz 3 lb 5 oz 3 lb 6 oz 3 lb 8 oz 3 lb 10 oz

NEW

SEEK_r R3



- R3 recyclable keeping the skis out of the landfill
- Super light and playful backcountry ski
- Polyurethane sidewalls for best-in-class dampness
- Magnetic contact points hold skis together without a strap for faster transitions and less fiddle
- Full carbon fibre construction creates a strong, light and torsionally stable ski
- Modern, all-mountain shape and profile for versatility

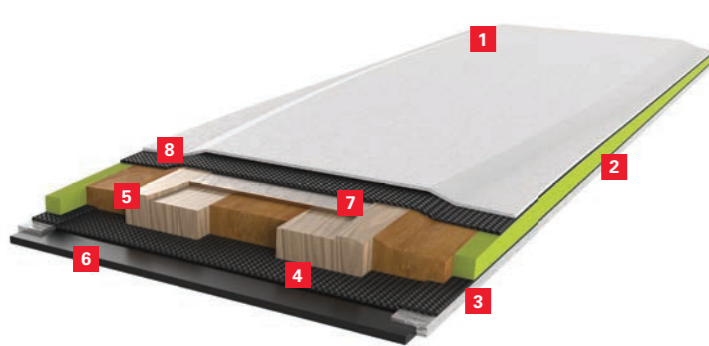

- 1 Super light textured nylon topsheet - durable & sheds snow/ice
- 2 PolyUrethane sidewall - durability & dampness
- 3 Lightweight hardened steel edges - corrosion & dent resistant
- 4 2 layers of carbon fibre, triaxial stitched - strong, light & torsionally stable
- 5 3D shaped Poplar Paulownia wood core - light & high performance
- 6 Full thickness base - durable, long-lasting & fast
- 7 Titanal aluminum mounting plate - mount integrity & dampness
- 8 2 layers of carbon fibre, quadraxial stitched - strong, light & torsionally stable

SLIGHT CAMBER WITH EARLY RISE

Built to be playful in the turn while remaining stable in variable conditions. The longer early rise in the tip and tail allows for smearability while the slight camber underfoot maintains stability and inspires confidence at speed.

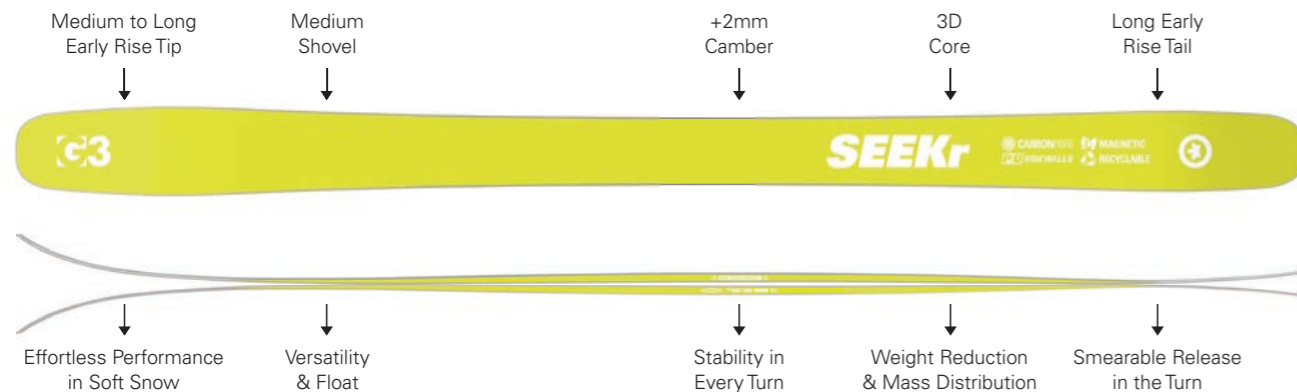

PATENT PENDING



SEEK_r R3 110

Lightest for its size and more playful than ever, the SEEK_r R3 110 crushes vertical for breakfast then feasts on all-you-can-eat powder until your tailgate apres session calls.

139 / 110 / 127 mm

SIZE:	-	172 cm	180 cm	188 cm
SWING	164 cm	-	-	-
RADIUS:	16.4 m	18.2 m	19.9 m	21.7 m
WEIGHT:	1.39 kg	1.46 kg	1.55 kg	1.62 kg
(single)	3 lb 1 oz	3 lb 3 oz	3 lb 7 oz	3 lb 9 oz

SEEK_r R3 100

Ridiculously light and agile, the SEEK_r R3 100 redefines backcountry performance and dare we say pleasure in that all-mountain sweet-spot of 100 mm underfoot.

132 / 100 / 120 mm

SIZE:	-	-	170 cm	178 cm	186 cm
SWING	154 cm	162 cm	-	-	-
RADIUS:	12.6 m	14.5 m	16.4 m	18.3 m	20.2 m
WEIGHT:	1.26 kg	1.33 kg	1.39 kg	1.46 kg	1.54 kg
(single)	2 lb 12 oz	2 lb 15 oz	3 lb 1 oz	3 lb 3 oz	3 lb 6 oz

NEW

ROAMr R3



- R3 recyclable keeping the skis out of the landfill
- Lightweight all-mountain ski
- Polyurethane sidewalls for best-in-class dampness
- Magnetic contact points hold skis together without a strap for faster transitions and less fiddle
- Two tip-to-tail layers of titanal aluminum for dampness and power in every turn
- One ski quiver built to ski in and out of bounds with ease

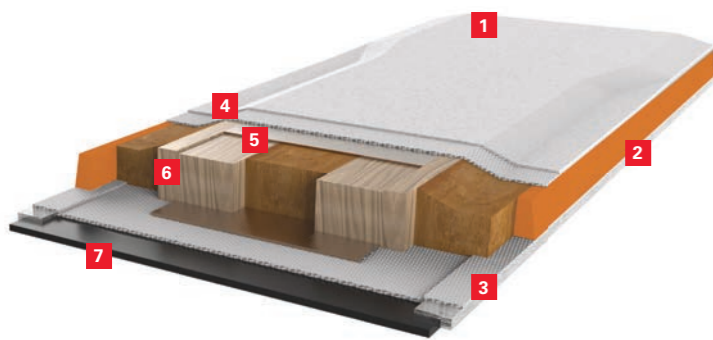

- 1 Textured co-extruded nylon topsheet - durable & sheds snow/ice
- 2 PolyUrethane sidewall - durability & dampness
- 3 Full thickness hardened steel edges - corrosion & dent resistant
- 4 Triaxial glass - torsion, flex & value
- 5 7000 series Titanal aluminum sheets - dampness & power
- 6 3D shaped Poplar Paulownia wood core - light & high performance
- 7 Full thickness base - durable, long-lasting & fast

MEDIUM CAMBER WITH EARLY RISE

The low profile early rise tip, just the right amount of camber underfoot, and flat rise tail give these skis a long effective edge and a smearable, smooth turn. This versatile, all-mountain performer floats like a longer ski and retains the fun of a shorter ski.

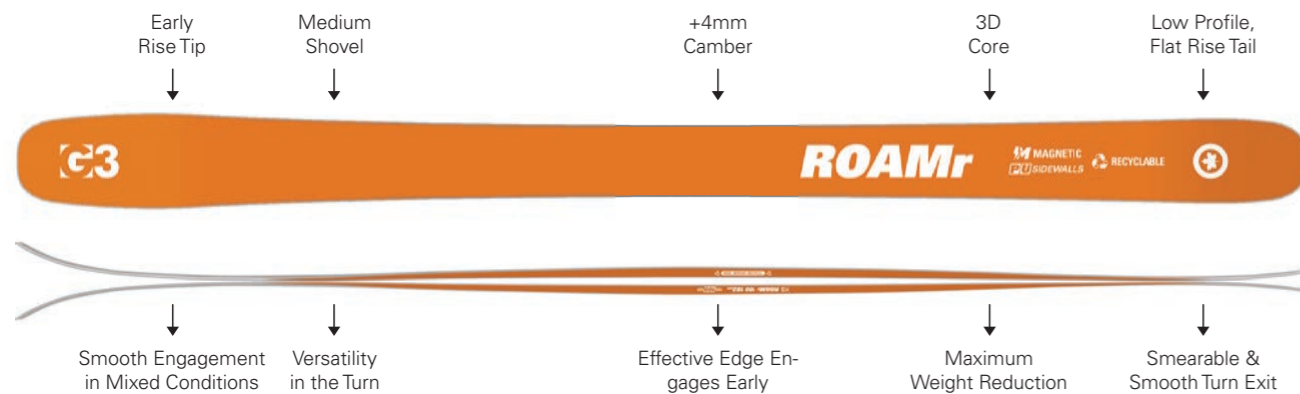

PATENT PENDING

79 ■ POWDER MASTER 2023-2024



ROAMr R3 108

This freeride focused ski has a longer early rise and a longer turn radius than the ROAMr R3 100 and is perfect for that skier spending 70% of their time in the backcountry and 30% at the resort.

139 / 108 / 124 mm

SIZE:	171 cm	178 cm	185 cm	192 cm
RADIUS:	21.8 m	23.6 m	25.4 m	27.4 m
WEIGHT: (single)	1.83 kg / 4 lb 0 oz	1.92 kg / 4 lb 4 oz	2.01 kg / 4 lb 7 oz	2.11 kg / 4 lb 10 oz

ROAMr R3 100

A one ski quiver built to ski in and out of bounds with ease. This playful ski is ideal for skiers spending around 30% of their time in the backcountry and 70% at the resort.

135 / 100 / 120 mm

SIZE:	-	-	172 cm	177 cm	182 cm	187 cm
WEIGHT: (single)	1.59 kg / 3 lb 8 oz	1.68 kg / 3 lb 11 oz	1.73 kg / 3 lb 13 oz	1.81 kg / 4 lb	1.88 kg / 4 lb 2 oz	1.93 kg / 4 lb 4 oz

NEW

SLAYr R3



- R3 recyclable keeping the skis out of the landfill
- Playful freeride performance at the lightest weight in its class
- Polyurethane sidewalls for best-in-class dampness
- Full carbon fibre construction creates a strong, light and torsionally stable ski
- Magnetic contact points hold skis together without a strap for faster transitions and less fiddle
- Two tip-to-tail layers of titanal aluminum for dampness and power in every turn
- Ultralight custom wood core with 45 degree wood grain for unparalleled weight to performance

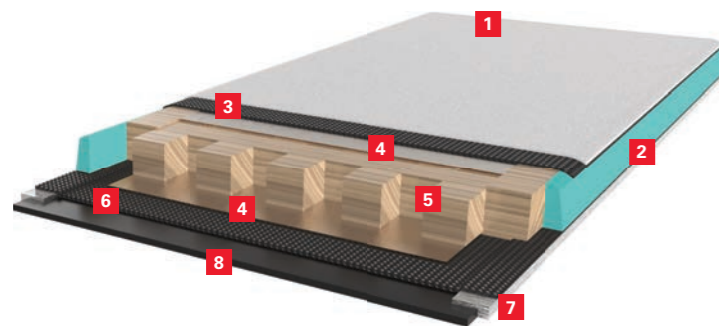

- 1 Textured co-extruded nylon topsheet - durable & sheds snow/ice
- 2 PolyUrethane sidewall - durability & dampness
- 3 2 layers of carbon fibre, triaxial stitched - strong, light & torsionally stable
- 4 7000 series Titanal aluminum sheets - dampness & power
- 5 Premium FSC-sourced Balsa wood core with 45 degree wood grain direction - unparalleled weight to performance
- 6 2 layers of carbon fibre, triaxial stitched - strong, light & torsionally stable
- 7 Full thickness hardened steel edges - corrosion & dent resistant
- 8 Full thickness base - durable, long-lasting & fast

FLAT CAMBER WITH EARLY RISE TIP & TAIL

The profile of the SLAYr is designed to be playful and easy to ski, yet stable at speed for big lines and aggressive skiing. The early rise in the tip and tail is drift and fun while the flat to slightly positive camber underfoot retains power at high speeds.

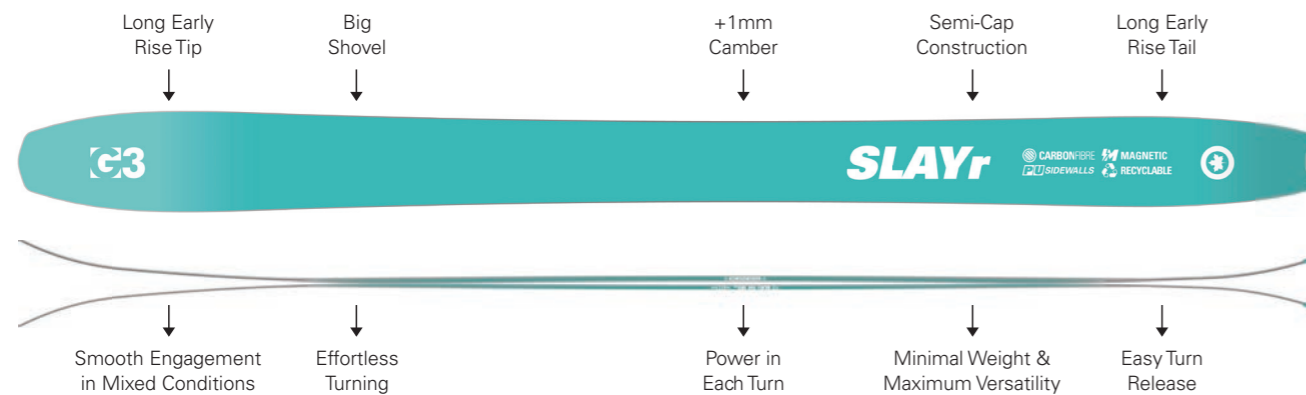

SLAYr R3 114

The SLAYr is freeride skiing at its ideal balance of lightweight, playfulness, and downhill performance. Super easy and fun to ski regardless of skill level, this ski is equally at home on big lines in far-off locales as it is buttering through the local trees on a powder day.

	143 / 114 / 128 mm				
SIZE:	-	178 cm	185 cm	190 cm	195 cm
SWING:	172 cm	-	-	-	-
RADIUS:	19.1 m	20.5 m	22.7 m	24.1 m	25.5 m
WEIGHT:	1.53 kg	1.61 kg	1.69 kg	1.73 kg	1.79 kg
(single)	3 lb 6 oz	3 lb 9 oz	3 lb 12 oz	3 lb 13 oz	3 lb 15 oz

AXLE



- ・全ての山で使用可能なスプリットボード
- ・遊び心があるシェイプはバックカントリーにおすすめ
- ・最高クラスの衝撃吸収性を誇るサイドウォール **PU**
- ・カーボンファイバーを基盤にしており捻じれに強く素晴らしいエッジコントロールを発揮



須田 建

・フレックスは柔らかく、かつ格子状のカーボンファイバーベースのおかげでしっかり粘りがあるので滑る斜面を選びません。
 ・Scape goatと同様に、短時間のアタックやロングアプローチ、深いラッセルでも足の負担は最小限になります。
 ・ナローな地形遊びやメローな斜面での優雅なターンまで楽しめる、シンプルかつ遊び心のある一枚です。

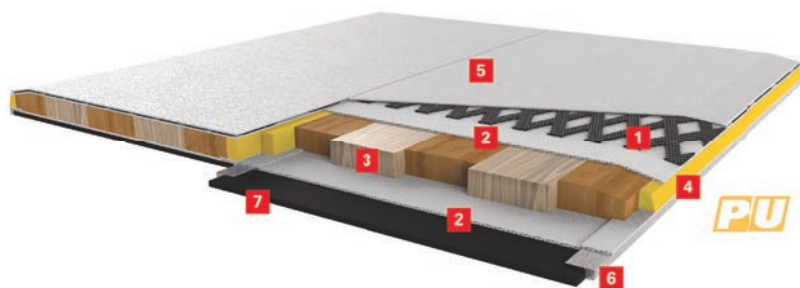

- 1 カーボンファイバーのベース - 捻じれに強く & エッジコントロールを向上させます
- 2 3方向から編んだグラスファイバー - 捻じれ剛性と柔軟性に優れています
- 3 ポプラと桐のウッドコア - 軽量性と長寿命な柔軟性を発揮します
- 4 ポリウレタンサイドウォール - 耐久性 & 衝撃吸収性に優れています
- 5 ナイロン製トップシート - 耐久性があり、雪と水に強いです
- 6 堅牢なスチール製エッジ - 錆びにくく、高耐久性
- 7 厚みのある滑走面ベース - 耐久性、寿命が長く & 滑走性も良好です

SLIGHT CAMBER WITH EARLY RISE

ターンに遊び心があるだけでなく、さまざまな条件下で安定性に優れています。アーリーライズなトップとテールとわずかなキャンバーはずらしのターンをする際に安定性を維持し、しっかりとスピードを出すことができます。



SIZE:	146 cm	150 cm	154 cm	158 cm	162 cm	168 cm
WIDTH:	TIP 000mm WAIST 000mm TAIL 000mm	TIP 000mm WAIST 000mm TAIL 000mm	TIP 292mm WAIST 255mm TAIL 290mm	TIP 298mm WAIST 256mm TAIL 290mm	TIP 300mm WAIST 257mm TAIL 292mm	TIP 302mm WAIST 259mm TAIL 294mm
RADIUS:	7.4 m	7.9 m	8.5 m	9.1 m	9.5 m	10.5 m
WEIGHT:	2.84 kg 6.26 lb	2.94 kg 6.48 lb	3.09 kg 6 lb 12 oz	3.28 kg 7 lb 3 oz	3.39 kg 7 lb 7 oz	3.56 kg 7 lb 13 oz

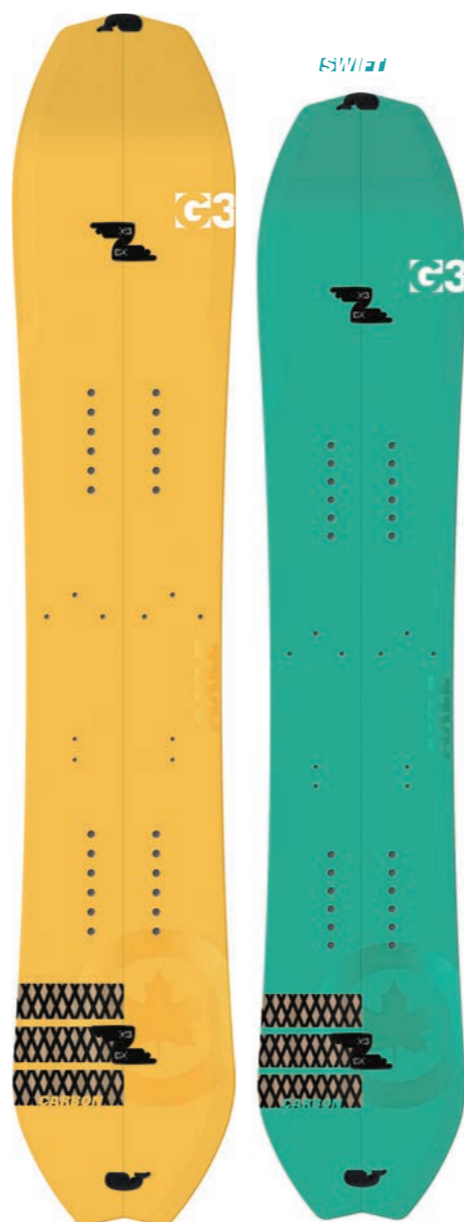

AXLE アクセル 7401120 ¥138,600(税抜¥126,000)

AXLEはオールマウンテンボードをスプリットしただけのボードではありません。バックカントリースプリットボーダーのためにデザインされた完全なるスプリットボードです。AXLEのデザインはスムーズなスキンの着け外しからスムーズなライディングまで素晴らしい機能性があります。



SPLIT BOARDS

SCAPE GOAT



- ・浮力に優れた高性能スプリットボードです。
- ・最高クラスの衝撃吸収性を誇るポリウレタンサイドウォール **PU**
- ・カーボンファイバー構造により、強く軽く、捻じれにくく安定性に優れています



須田 建

・トップシート下のカーボンシートによって剛性を高め、軽量化してもいるにも関わらず高い走破性を持っています。
 ・短時間のアタックやロングアプローチ、深いラッセルでも足の負担は最小限になります。
 ・アルパインでもトップスピードでビックターンを決められる安心感のある一枚です。
 ・ディープパウダーでも高い浮力を発揮して、リラックスしながら雪面に理想のラインを描けます。

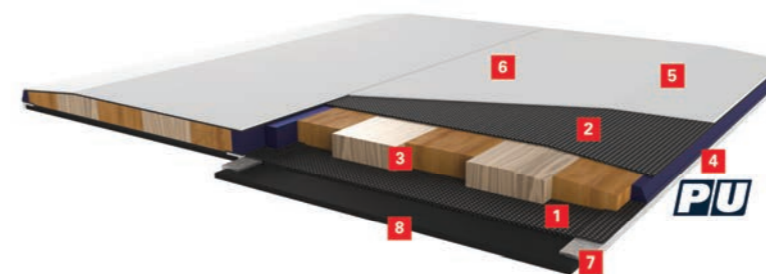

- 1 3方向から編んだカーボンファイバー。強く、軽量性、安定感に優れています
- 2 2方向から編んだカーボンシート - 強く、軽く、ねじれ剛性に強いです
- 3 ポプラ & 桐パウロニア材ウッドコア - 軽量でロングターンに適した厚みとシェイプ
- 4 ポリウレタンのサイドウォール - 高耐久性と振動吸収性
- 5 ステルスレーザエッジプロファイル - トータルの質量を減らし、軽量化
- 6 プレミアムナイロンのトップシート - 耐久性と雪と氷を防ぎます
- 7 厚みがあり固いスチールエッジ - 錆びにくいロックウェル C48 を採用
- 8 厚みのある滑走面ベース - P-TEX2000 エレクトラを採用

POWDER ROCKER

足元には、キャンバーとロッカーチップを採用しています。G3のパウダーロッカーは、テールがしっかりと雪面に沈み、ノーズ部分は高く上がることで、ディープパウダーでの最高のランを実現します。タイトなツリーランで素早い反応をし、脚の疲れを感じにくい板です



SCAPEGOAT スケープゴート 7400986 ¥149,600(税抜¥136,000)

足元にはキャンバー、パウダーロッカーノーズが素晴らしい浮力を実現しています。ウッドコアを上下から厚みを変えたカーボンシートで挟み込み軽量、高強度、強いねじれ剛性を実現しています。最高のコンディションの日に長時間ハイクが必要なBigdaysに真価を発揮してくれるでしょう。

SIZE:	150 cm	154 cm	158 cm	162 cm	168 cm
WIDTH:	TIP 000mm WAIST 000mm TAIL 000mm	TIP 000mm WAIST 000mm TAIL 000mm	TIP 310mm WAIST 257mm TAIL 295mm	TIP 313mm WAIST 260mm TAIL 298mm	TIP 317mm WAIST 264mm TAIL 292mm
TAPER:	25mm	25mm	25mm	25mm	25mm
RADIUS:	7.1 m	7.7 m	8.2 m	8.7 m	9.4 m
WEIGHT:	2.79 kg 6.15 lb	2.92 kg 6.44 lb	3.02 kg 6 lb 10 oz	3.15 kg 6 lb 15 oz	3.34 kg 7 lb 5 oz

ZED

BACKPACKER
EDITOR'S
CHOICE
2019

FREESKIERS
EDITORS' PICK

SPECIAL READER'S
3500

SKI
RECOMMENDED

BLISTER
RECOMMENDED

2020
MAGAZINE
EDITORS' CHOICE

BACKCOUNTRY
EDITORS' CHOICE

Gear Guide
Select

BLISTER
RECOMMENDED

OUTSIDE
BUYER'S GUIDE
2022



GO LIGHTER.

ION をプラットフォームとして全てのパーツ、メカニズム、スクリューに至るまで理想的な特徴を持った最軽量のビンディングの進化を遂げました。

- 1 垂直方向と横方向の解放値を一つのスクリューで調節できます。
- 2 シンプルで最低限のブーツストッパーでステップインできます。
- 3 軽量さを追求しつつ流れるような美しいデザインとなっています。



GO FURTHER.

バックカントリースキーヤーがシンプルに効率的に、より速くの山へ行けるようにすることに焦点を当てています。ZED は出来る限りの軽量化を行い、山奥から確実に帰ってくるのできるビンディングです。

- 4 クイックフリックヒールリフターはスキーボールで簡単に操作できます。
- 5 ヒールタレットは両方向へ回転させることができます。
- 6 3番のボジドライバー 1本でビンディングのmountから調整まで行えます。
- 7 ヒールピースの調整幅は 30 mm です。
- 8 トウのビン部分はステップイン毎に雪が詰まらないようにするクリーンアップ機能があります。
- 9 トウとブレーキのデザインは常に雪を排除しステップインを確実に行えるようになっています。



GO HARD.

ZED は軽く、そして簡単にハイクアップできます。もしあなたがその日の行動で滑走できなかったとしても ZED を使用することによって満足感を得られるでしょう。全てのパワーとパフォーマンスを持つ他社の最新のビンディングの中でも良いポジションに位置しますがその中でも超軽量かつシンプルでコンパクトなビンディングです。

- 10 トウ部分の弾力性が大きなエネルギーを吸収し誤解放を最小限にします。
- 11 ヒール部分の 10 mm 幅の前圧はどのような状況でもリリースを可能にしています。
- 12 広範囲にmountさせることによってスキーに力が伝わりさらにビンディングを固定しているビスが板から抜けずらくなっています。
- 13 タレットとメタルのベース廻りはスキーへ正確に力を伝えます。
- 14 ストンプパッドはブーツとの接地を適度なものにします。
- 15 オプションのブレーキは簡単に取り外しが可能です。
- 16 アイシーコンディションで使用する ION クランポンは ZED でも共通使用が可能です。

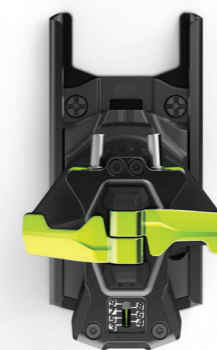

別売ブレーキ
85mm
100mm
115mm
130mm



NEW
ZED 12 7401220
ゼド12 ¥75,900 (税抜¥69,000)

より軽く、より速くへ、よりハードにZEDはハイパフォーマンスツアービンディングの次世代の進化を再定義するビンディングです。シンプルで最低限のブーツストッパーと超軽量のステップインガイドを搭載。

縦方向と横方向の解放値の調整が一本のネジによって行えます。

IONクランポンはZEDでも共用できます。

IONマウンティングジグが共用できます。

長さ30mmの調整が可能です。

解放値5-12

重量358g (ブレーキなし)

NEW
ZED 9 7401221
ゼド9 ¥71,500 (税抜¥65,000)

軽量ユーザー向けに調整されたZED 9は、軽量で使いやすい理想的なダウンヒルパフォーマンスと安全性のバランスが実現しています。

ロングカーボンファイバー強化ナイロントウは、強度、重量、および価格のバランスを取ります

テックビンディングを使用する次世代のスキーヤーのために解放値は3から設定可能です

特徴的なトウレバー機構

IONクランポンはZEDでも共用できます。

IONマウンティングジグが共用できます。

長さ30mmの調整が可能です。

解放値3-9

重量345g (ブレーキなし)

NEW
ZED BRAKES 7401223
¥11,550 (税抜¥10,500)

3番のボジドライバーでフィールドでも簡単に取り外しが出来ます。

85 mm	83 g / 2.9 oz (single)
100 mm	85 g / 3.0 oz (single)
115 mm	87 g / 3.1 oz (single)
130 mm	88 g / 3.1 oz (single)

ION



HIGH PERFORMANCE IN A PROVEN PLATFORM

IONシリーズは高度な技術を用いたビンディングです。トゥピースの確かなホールド性能により、ヒールピースへ非常に強い力が加わっても、しっかりと保持し、設定した解放値どおりに必ず解放します。フリーライドマウントポジションがエッジへのパワー伝達と捻じれ剛性を高め、過剰な反発力を吸収します。開発ルームでの過酷なテストと実際のフィールドテストを繰り返し、ユーザーの限界をpushできる最高のビンディングを作り上げました。



SIMPLE & INTUITIVE

IONビンディングは非常に多用途に使用でき、効率性、信頼性の高いステップインビンディングと言えます。ブーツストッパーにブーツのつま先を合わせることで、他のビンディングには真似のできない素早い装着ができ、それはどのようなコンディションでも変わりません。クイックフリックヒールリフトは、スキーポールまたは手で簡単に調整が可能で、ヒールをいずれかの方向に半回転しロックすることによって、ツアーリングモードにもなります。ビンディングはプラス3番のドライバーで取り付けや調整がすべて可能です。これにより、あなたがツアーに持って行く道具も減らせます。多彩な機能を持つIONによって、いつでもベストなコンディションでスキーツアーを行なうことができます。

RELIABLE & DURABLE

実は気が付かないところでIONビンディングは良い仕事をしてくれています。それは、氷や雪がビンディングに付着しない機能や、他のビンディングでは誤解放を防ぐため必要な、一度ステップインしたビンディングを再度ステップインする、プレリリースが不要な点です。ブレーキはスプリングの力を利用したステップインで機能し、重くパワフルなフリーライドスキーの滑落も止める能力があります。また、ブーツヒールがスライドする部分のAFD(アンチフリクションデバイス)は、どのようなブーツでも滑らかにスライドし、常に解放させることができます。このような素晴らしい機能により、集中してスキーを楽しむことができます。



NEW
ION 12 7401224
アイオン12 ¥85,800 (税抜¥78,000)

IONは市場にある最もパワフルで、直感的な操作ができる軽量フリーライドツアーリングビンディングで、先進的な発想で開発しました。フロントピースは新しい設計でダイナミックかつ洗練された構造で、保持力、復元力共に優れているので歩行モード、滑走モードのビンディング能力が高まっています。また、素早いブーツの着脱は今までにない装着感です。ヒールにも今までにないアルペンビンディングに近い前圧をかける事のできる構造となり振動吸収、誤解放が起こりにくくなっています。ブーツとフロントピース、ブレーキとの密着度も高まりかつて無いパワー伝達も可能となりました。そしてスタイリッシュなデザインが気分を盛り上げてくれます!

22mm length adjustment
Brake Options 85/100/115/130mm
5-12 RV
579g (1/2ピース)
ブーツの高さ フロント27mm、ヒール30mm

NEW
ION 10 7401225
アイオン10 ¥83,600 (税抜¥76,000)

コストパフォーマンスにも優れ、解放値を4-10までの設定にしたION10。ION12の性能はそのままにより幅広いスキーヤーに使用して頂けるビンディングとなりました。

22mm length adjustment
Brake Options 85/100/115/130mm
4-10 RV
579g (1/2ピース)
ブーツの高さ フロント27mm、ヒール30mm

ZED & ION ACCESSORIES



ZED&ION SKI CRAMPON

7400819 ¥18,700 (税抜¥17,000)
 堅い雪やアイシーコンディションの場合に有効なクランポン。片手で簡単に着脱可能です。ZEDとIONどちらのビンディングでも使用可能です。

85 / 95 / 105 / 115 / 130 mm

137 g / 4.8 oz (single)

Embossed 7075-T6 aluminum



ION CRAMPON ADAPTAR KIT

7400813 ペア ¥4,180 (税抜¥3,800)
 ION、ZED共用クランポンを載せ替えるアダプターパーツ。



SCREW ION CRAMPON (1本)

7401118 1本 ¥55 (税抜¥50)
 ION、ZED共用クランポンを載せ替えるアダプターを固定するネジです。



ZED DEMO TRACK

7401226 ¥9,680 (税抜¥8,800)
 ZEDのレンタルビンディング用トラックです。62mm幅でcmサイズで7サイズに対応しビンディング調整ができます。通常のZEDビンディングプレートから交換して使用します。重量は5g (片方) です。



ION 12 DEMO ION 10 DEMO

7401228 ¥96,800 (税抜¥88,000)
 7401229 ¥96,800 (税抜¥88,000)



SKI LEASH COILED

7401026 ¥6,160 (税抜¥5,600)
 簡単にどんなスキーブーツへも取り付け可能なコイルケーブルリッシュ。ブーツコネクターループが付属されています。

BINDING TOOLS



SHOP TECH POZIDRIV #3 SCREWDRIVER

7401015 ¥2,310 (税抜¥2,100)
 ION等のビンディング取り付けに最適なドライバー。滑りにくいチップコーティングが施されています。



POZIDRIV #3 DRIVER BIT

7401025 ¥1,980 (税抜¥1,800)
 素晴らしくしっかりとビスヘッドに喰いこみナメル心配の無い、6インチのドライバービットです。



ZED FREERIDE STOMP PAD

7401069 ¥3,520 (税抜¥3,200)



BACKCOUNTRY BINDING TOOL POZI #3 & TORX T20

7401152 ¥2,750 (税抜¥2,500)
 G3ビンディングのすべての調整が行なえる工具です。ボンドライバーの3番とTorx T20を装備。汎用性があり、すべてのバックカントリースキーヤーに役立ちます。



ZED&ION SPIRAL MOUNTAIN JIG

7401102 ¥66,000 (税抜¥60,000)
 スキー対応幅: 75~140mm



バインディング グリス 3 oz.

7400491 ¥4,400 (税抜¥4,000)
 タルガアッセント、オニキス、Ionバインディングの可動部に使用するグリス。

SKI & BOARD ACCESSORIES

テンションストラップ

7401056 40cm ¥1,210 (税抜¥1,100)
 7401057 50cm ¥1,320 (税抜¥1,200)
 7401058 65cm ¥1,595 (税抜¥1,450)

低温化においてもとてもタフで柔軟なG3テンションストラップはスキー等を縛ることができます。紐やダクトテープよりも多用途に使え、信頼感がありバックに常に入れておくことにより様々な使い方ができます。短いサイズはスキー等を束ね、長いサイズは大きく、かさばる物を縛りバックに固定するのに便利です。バック以外にもラックや自転車にも固定することができます。



テンションストラップ アソート (24個)

7401064 50cm
 ¥28,600 (税抜¥26,000)



NEW

TENSION STRAP CUSTOM PRINTING

Customize your G3 Tension Straps with your brand name or logo. We offer custom logo printing for all our Tension Straps when ordered in bulk.

New printing capabilities at G3 have opened up **lower minimums, multiple colour prints, and faster turnarounds!** Reach out to us at service@genuineguidegear.com for details.





WHY G3? | SKINS

As the market leader in climbing skins we focus on a full line approach where every skier in any condition anywhere in the world has the perfect G3 skin to choose from. Every decision we make is focused on enabling the user to do more in the backcountry.



BEST-IN-CLASS PLUSH FABRICS

G3 develops premium nylon, mohair, and mixed plush materials to design the right solution for each backcountry user.

UNIVERSAL

Any location and all conditions. Universal nylon plush material is durable and versatile. Optimal balance of grip, glide, weight and durability.

GRIP

Maximum grip and traction ideal for steep ascents and icy skin tracks. High-traction nylon plush material for durability and versatility.

GLIDE

All-purpose, go-anywhere skin built for cold and dry conditions with premium water-proofing. 65% mohair for optimal glide and 35% nylon for added durability.

UNRIVALED TIP & TAIL CONNECTION

The innovative, patented tip and tail connectors in all G3 skins create a lightweight, solid and reliable connection to your skis or board. The self-aligning hands fit easily on any shape, and the camming tails on all skins are super easy to attach and remove in any condition.



SELF-ALIGNING HANDS

Every G3 skin model features self-aligning stainless steel hands; offering a secure, lightweight connection on any ski shape. Patent US8474853



EASY TRANSITIONS & BOMBER CONNECTION

G3's low profile, elongated tail strap makes transitions fast and easy. The camming clip stays positioned on the ski or board, reduces wear and allows for easy adjustments.

RELIABLE ADHESIVE

Climbing skin adhesive is best when you never notice it and it just works the way you expect it. So many variables can affect the way your adhesive performs, and we are constantly working to improve the product so it is prepared for any scenario. The adhesive used in all G3 skins features a refined formula engineered to let you do more laps and cover more terrain without having to worry about your skins.

NEW FOR 2023/2024

TOPSHEET-MOUNTED TAIL CONNECTORS FOR G3 CLIMBING SKINS

Replace the tail connector on your G3 climbing skins with this ultra-light and simple accessory to be lighter, faster, and more packable.

- Mounts permanently to your ski/board topsheet with a bomber adhesive
- Removes bulk from packed skins
- Super fast and easy transitions
- Compatible with any G3 climbing skins with holes in the tail strap
- Weighs just 2g each (saving 13g vs traditional tail clips)
- Fits skis and boards of any shape

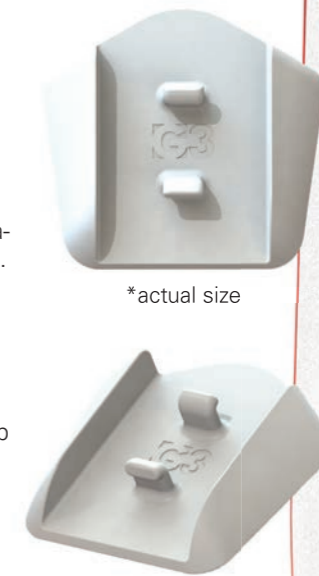
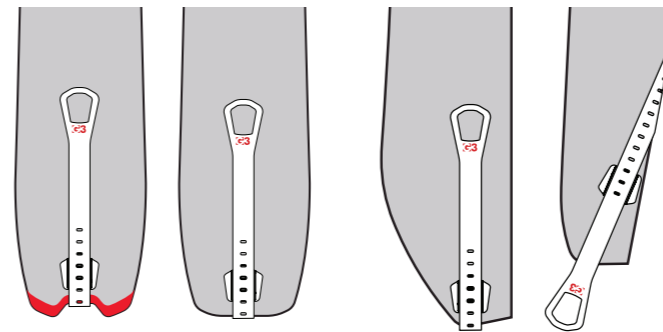

*actual size

PATENT PENDING



PFC-FREE WATER REPELLENCY ON ALL SKINS

- Waterproofing in G3 skins is completely PFC-free (perfluorocarbon)
- High level of environmental stewardship without sacrificing performance
- This waterproofing embeds itself into the fibres and wraps around every thread in the plush for superior protection and durability
- Better for the environment and for everyone who handles the skins by eliminating harmful C6 chemicals



SIMPLE PACKAGING

- Less waste
- Simple and easy to stock
- All items are included in the box
- Box can be shipped on its own for online customers



TRIM TOOL & SKIN SAVERS INCLUDED



RECYCLED & RECYCLABLE STORAGE BAG & BOX



MADE IN CANADA



ALPINIST+



WHERE DOES GRIP COME FROM?

クライミングスキンのデザインに対する挑戦は一見すると答えがありませんが、スキー全体を覆ってしまうことは過剰であり重くなってしまいます原因となります。そこでビンディングの下回りのみグリップ力をもたせ無駄な引っ掛かりとなるトップとテールの周りのスキンは排除しました。スキーの滑走面を有効に利用したグライド性と新素材スキンとトップ部分のグリップ性を効果的に引き出しています。

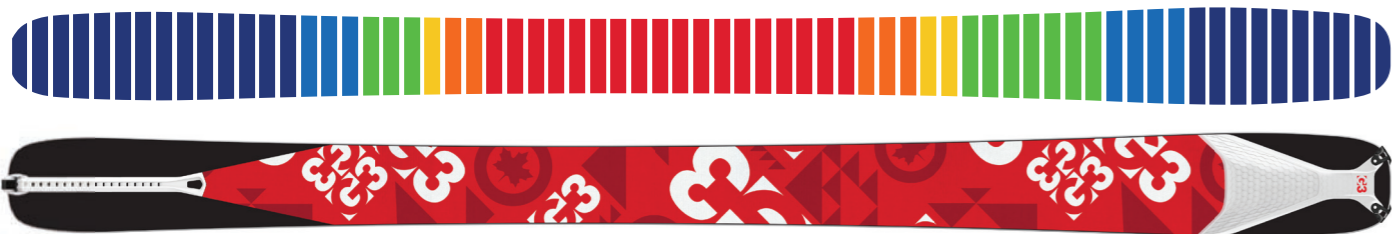

NO MORE SNOW CREEP

ALPINIST+のトップ部分の素材は湾曲しており、歪みづらく雪がシールと滑走面の間に潜り込むのを防ぎ接着面の寿命を延ばします。

EASY TRANSITIONS & BOMBER CONNECTIONS

G3のスキンはクリップのポジションもずれにくく付け外しや調整が簡単に可能です。また板のテールからずれにくく、調整も簡単に可能です。



ALPINIST+ UNIVERSAL

アルピニストプラス ユニバーサル
あらゆる地形や雪質においてもオールラウンドに使用できます。ナイロンの植毛素材は耐久性と多様性があり、グリップ、グライド、重量、耐久性のバランスが最適です。

7401230	100mm	¥26,400 (税抜¥24,000)
7401232	115mm	¥26,950 (税抜¥24,500)
7401233	130mm	¥28,600 (税抜¥26,000)
7401234	145mm	¥29,150 (税抜¥26,500)

	XS 150-166 cm	S 161-177 cm	M 172-188 cm	L 183-199 cm
mm				
100	249g 8.8 oz	262g 9.2 oz	277g 9.8 oz	289g 10.2 oz
115	269g 9.5 oz	291g 10.3 oz	310g 10.9 oz	331g 11.7 oz
130	299g 10.5 oz	314g 11.1 oz	334g 11.8 oz	365g 12.9 oz
145	308g 10.9 oz	333g 11.8 oz	364g 12.8 oz	382g 13.5 oz

トリムツール、ケース付

ALPINIST+ GRIP

アルピニストプラス グリップ
ラインナップの中で最もグリップ力があり急斜面でもアイシーコンディションにおいても理想的なトラクションを発揮します。ハイトラクションなナイロンの植毛素材は耐久性がありあらゆるシーンで使用可能です。

7401236	100mm	¥27,500 (税抜¥25,000)
7401237	115mm	¥28,600 (税抜¥26,000)
7401238	130mm	¥29,700 (税抜¥27,000)
7401239	145mm	¥30,800 (税抜¥28,000)

	XS 150-166 cm	S 161-177 cm	M 172-188 cm	L 183-199 cm
mm				
100	257g 9.1 oz	275g 9.7 oz	297g 10.5 oz	312g 11.0 oz
115	281g 9.9 oz	306g 10.8 oz	334g 11.8 oz	344g 12.1 oz
130	307g 10.8 oz	330g 11.7 oz	358g 12.6 oz	376g 13.3 oz
145	325g 11.5 oz	352g 12.4 oz	374g 13.2 oz	405g 14.3 oz

トリムツール、ケース付

ALPINIST+ GLIDE

アルピニストプラス グライド
GLIDEは防水加工がされ改良されたスキンで寒冷かつドライコンディションでも効果を発揮します。70%モヘア、30%ナイロンの組み合わせにより最適なグライド性だけでなく軽量で耐久性もあります。

7401240	100mm	¥28,600 (税抜¥26,000)
7401241	115mm	¥29,700 (税抜¥27,000)
7401242	130mm	¥30,800 (税抜¥28,000)
7401243	145mm	¥31,900 (税抜¥29,000)

	XS 150-166 cm	S 161-177 cm	M 172-188 cm	L 183-199 cm
mm				
100	239g 8.4 oz	254g 8.9 oz	264g 9.3 oz	284g 10.0 oz
115	265g 9.3 oz	283g 10.0 oz	302g 10.7 oz	319g 11.3 oz
130	276g 9.7 oz	307g 10.8 oz	315g 11.1 oz	335g 11.8 oz
145	308g 10.9 oz	318g 11.2 oz	350g 12.3 oz	374g 13.2 oz

トリムツール、ケース付

MINIMIST



UNCOMPROMISED PERFORMANCE AT AN UNRIVALED WEIGHT

ミニミストスキンは特殊な繊維を挟み強度と剛性をだしつつもスキン史上最薄で最軽量に仕上がっています。結果として期待以上の性能とパフォーマンスを発揮します。ミニミストスキンは同じレベルのパフォーマンスを発揮する他のスキンより30%軽量です。



COMPACT PACKABILITY

コンパクトに収納可能

ミニミストスキンはジャケットのポケットに収納可能なくらい小さいです。チップとテールのシステムの素材の体積が小さいためコンパクトにまとまる為、余分な収納スペースを必要としません。



PACKED VOLUME FOR 130 mm SKIN

LATERALLY STIFF TO REDUCE SNOW CREEP

トップ部分にカーボンシートをインサートし雪の侵入を防ぐ

ALPINIST+スキンを改良し続け我々はこのように雪がスキンと滑走面に入り込み接着面を剥がして行くのかを学びました。我々はミニミストのような軽量化を目的としたデザインをすることに情熱を注いできました。なにが我々の解決策なのか？ ミニミストスキンのトップコネクタ部分にはカーボンファイバーを使用しており、縦方向には硬く、横方向には柔軟性を持たせ、しっかりと接着するようにしています。そのおかげでトップからの雪の侵入を防ぎあなたが山で楽しむ時間が増えるでしょう。



MINIMIST UNIVERSAL

ミニミスト ユニバーサル

バランスが取れ耐久度の高いアルピニストスキンを基に、最も軽量のミニミストユニバーサルは開発されました。非常に収納性に優れ世界中に並ぶものがないほどグリップ、グライド、重量、耐久性のバランスが取れたモデルになっています。テールクリップが新しくなりました。

7401245	100mm	¥31,900 (税抜¥29,000)
7401246	115mm	¥33,000 (税抜¥30,000)
7401247	130mm	¥34,100 (税抜¥31,000)
7401248	145mm	¥35,200 (税抜¥32,000)

	XS 150-166 cm	S 161-177 cm	M 172-188 cm	L 183-199 cm
mm				
100	197 g 6.9 oz	210 g 7.4 oz	223 g 7.9 oz	246 g 8.7 oz
115	227 g 8.0 oz	235 g 8.3 oz	253 g 8.9 oz	259 g 9.1 oz
130	246 g 8.7 oz	254 g 8.9 oz	272 g 9.6 oz	294 g 10.4 oz
145	251 g 8.9 oz	271 g 9.6 oz	295 g 10.4 oz	303 g 10.7 oz

トリムツール、ケース付

MINIMIST GLIDE

ミニミスト グライド

オールラウンドに使用できるように設計され70%モヘア30%ナイロンの割合で植毛され現代の全てのスキーヤーの要望を満たしたスキンになっています。このスキンは非常に軽量で世界中のモヘアミックススキンの中で最もコンパクトになります。テールクリップが新しくなりました。

7401250	100mm	¥31,900 (税抜¥29,000)
7401251	115mm	¥34,100 (税抜¥31,000)
7401252	130mm	¥35,200 (税抜¥32,000)

	XS 150-166 cm	S 161-177 cm	M 172-188 cm	L 183-199 cm
mm				
100	200 g 7.1 oz	209 g 7.4 oz	227 g 8.0 oz	245 g 8.6 oz
115	228 g 8.1 oz	237 g 8.4 oz	258 g 9.1 oz	269 g 9.5 oz
130	245 g 8.6 oz	253 g 8.9 oz	274 g 9.7 oz	294 g 10.4 oz

トリムツール、ケース付

ESCAPIST

QUICK & EASY CUSTOM SETUP

エスケーピストはご自身で長さを調節できるクライミングスキンです。使用者は自身のスキーの全長とエッジに合わせてセットアップすることが可能です。セットアップの仕方も非常に簡単で、カットする際には付属しているトリムツールとカット用の付属のシート以外は必要ありません。

G3 SELF-ALIGNING HANDS

自動調節チップコネクタ

スキンを取り付ける際にエスケーピストスキンは特許取得済みのステンレススチールのコネクタでスキーのトップがどのような形状であってもしっかりとセットすることができます。エスケーピストスキンは他社のチップコネクタと比べ、とても便利でこれからの調整式スキンのスタンダードとなるでしょう。

SIMPLE SIZING & MERCHANDISING

ワイズごとにSサイズとLサイズの2種類の長さで、販売する際に購入者の求めるクオリティを幅広くカバーすることができます。



ESCAPIST UNIVERSAL

エスケーピスト ユニバーサル

エスケーピストユニバーサルスキンは、低価格で多様なパフォーマンスを発揮し、セットアップと同様に使用も簡単なニュースキンです。ナイロン100%です。テールグリップが新しくなりました。

7401260	70mm L	¥24,200 (税抜¥22,000)
7401261	100mm S	¥27,500 (税抜¥25,000)
7401261	100mm L	¥27,500 (税抜¥25,000)
7401262	120mm S	¥28,600 (税抜¥26,000)
7401262	120mm L	¥28,600 (税抜¥26,000)
7401263	140mm L	¥30,800 (税抜¥28,000)
	S	L
	Up to 175 cm	Up to 200 cm

mm	Features tip loop sized for skinny & nordic-style skis		
50	-	171 g	6.0 oz
70	-	226 g	8.0 oz
100	288 g	323 g	11.4 oz
	10.1 oz		
120	335 g	378 g	13.3 oz
	11.8 oz		
140	-	432 g	15.2 oz
	-		

トリムツール、ケース付



SPLITBOARD⁺



UPDATED

ASYMMETRICAL TIP CONNECTOR

G3のスプリットボードスキンのチップコネクタは定評のあるスキー用のチップを改良して作られています。ステンレススチール素材によって簡単に装着できるのでスキンチップを簡単に板へ導くことができ、軽量でどのようなボードのシェイプでも装着できます。

INNOVATIVE CAMMING TAIL CONNECTOR

今までよりもスムーズにスキンを固定する事ができるようになりました。新しいSPLITBOARD+のテールコネクタの特徴はストレートなエッジ側でボードへ装着でき、シンプルなクリップを最小限の力により固定することができます。

PRE-CUT STRAIGHT EDGE

ストレート側はエッジに合わせたプレカットを施していますので、サイドカーブのある方だけ、ボードのエッジに合わせてカットするだけでカスタマイズできます。

NEW SIZING WITH MORE OVERLAP

スキンのサイズは多くのスプリットボーダーの意見を聞き、反映しました。S/MとM/Lサイズでは8cmサイズが重複しており、スキンが板を覆う面積を広くするか、少なくするか選択できるようになっています。



SELF-ALIGNING HANDS



NON-TOXIC ADHESIVE



REMOVABLE RIPSTRIP



ECO DWR PFC-FREE WATER REPELLENCY



18cm LENGTH ADJUSTABILITY



-30°C/-22°F ADHESIVE



MADE IN CANADA



TRIM TOOL INCLUDED

NEW SPLITBOARD⁺ UNIVERSAL

スプリットボードプラス ユニバーサル

あらゆる地形や雪質においてもオールラウンドに使用できます。ナイロンの植毛素材は耐久性と多様性があります。そしてグリップ、グライド、重量、耐久性のバランスが最適です。

7401270 ¥30,800 (税抜¥28,000)

S/M	140 mm	144-162 cm	277 g / 9.8 oz
M/L	140 mm	154-172 cm	302 g / 10.6 oz

NEW SPLITBOARD⁺ GRIP

スプリットボードプラス グリップ

ラインナップの中で最もグリップ力があり急斜面でもアイシーコンディションにおいても理想的なトラクションを発揮します。ハイトラクションなナイロンの植毛素材は耐久性がありあらゆるシーンで使用可能です。

7401271 ¥31,900 (税抜¥29,000)

S/M	140 mm	144-162 cm	301 g / 10.6 oz
M/L	140 mm	154-172 cm	328 g / 11.6 oz

SPLITBOARD LT



OUTSIDE BUYER'S GUIDE 2022



UNCOMPROMISED PERFORMANCE AT AN UNRIVALED WEIGHT

SPLITBOARD LTスキンは、要求の厳しい他のスポーツ同様に高性能テクスタイルをバックボーンとし比類のない軽量性を実現します。これにより、期待を超える登坂性を発揮します。機能性とパフォーマンスに優れた、SPLITBOARD LTスキンは、同じパフォーマンスクラスのどのスキンよりも約15%軽量です。

COMPACT PACKABILITY

SPLITBOARD LTスキンは、どこにでも収まるほど小さく収納できます。必要最小限のチップとテールシステムとかさばらない素材が組み合わさることによって、収納時に余分なスペースを必要としない、コンパクトなロールを作ることができます。

SPLITBOARD-SPECIFIC FROM THE GROUND UP

ストレートなエッジ側の固定ハンドと可動式のチップコネクタ、カムテールコネクタ、ストレートなエッジ側は事前にカットされたスキンにミニマリストチップが組み合わさって、軽量であらゆる形状のボードに容易なセットを実現します。



SELF-ALIGNING HANDS



NON-TOXIC ADHESIVE



REMOVABLE RIPSTRIP



ECO DWR PFC-FREE WATER REPELLENCY



18cm LENGTH ADJUSTABILITY



-30°C/-22°F ADHESIVE



MADE IN CANADA



TRIM TOOL INCLUDED

NEW SPLITBOARD LT UNIVERSAL

スプリットボードLT ユニバーサル

あらゆる場所・条件で軽量かつコンパクトに収納可能なスキンです。ユニバーサルスキンはオールラウンドかつ耐久性に優れており、グリップ性/グライド性/重量/耐久性の最適なバランスがとれたモデルです。

7401272 ¥31,900 (税抜¥29,000)

S/M	140 mm	144-162 cm	253 g / 8.9 oz
M/L	140 mm	154-172 cm	275 g / 9.7 oz

NEW SPLITBOARD LT GLIDE

スプリットボードLT グライド

最高のスプリットボードスキン。低温下や乾燥したコンディションなどすべての目的のために作られた持ち運びしやすい理想的なスキン。最適なグライド性を実現するモヘアと耐久性を高めるナイロンを組み合わせたモデルです。

7401273 ¥33,000 (税抜¥30,000)

S/M	140 mm	144-162 cm	241 g / 8.5 oz
M/L	140 mm	154-172 cm	262 g / 9.2 oz

SKIN ACCESSORIES

MAINTENANCE & SETUP



スキンワックス キット

7401274 1個 ¥3,520(税抜¥3,200)

フィールドでスキンへ直に塗りつけて使用します。それにより、雪質のコンディションが多様な場合に水をはじき雪団子がスキンに付くのを防ぎます。

発注単位：8個

Biodegradable | 0% Petroleum

60 g / 2.1 oz

Sold as singles or in pack of 24

Plant-based | PFC Free

Includes wax, scraper & storage bag



グルーシート

7400266
¥6,380(税抜¥5,800)
長さ=210cm×幅140mm
張り替え用粘着シート

グルーシートロール

7400069
¥52,800(税抜¥48,000)
長さ=45.7m×幅140mm
張り替え用粘着シートロール



TRIMTOOL

¥2,750(税抜¥2,500)

The G3 trim tool makes skin trimming lightning quick and easy by always delivering the perfect edge reveal without having to reposition the skin once it is applied to the base of the ski.



ウォータープルーフ RENEW

7401214 1本 ¥4,180(税抜¥3,800)

フィールドでスキンへ直に塗りつけて使用します。それにより、雪質のコンディションが多様な場合に水をはじき雪団子がスキンに付くのを防ぎます。

発注単位：8本

Made in Canada

60 ml / 2 oz

Sold as singles or in pack of 8

STORAGE



スキンバッグ

7401051 STANDARD ¥2,750(税抜¥2,500)

G3のスキンバッグは、リサイクル素材を使用しています。シンプルで軽量、そして安全なので、バックカントリーに持っていくスキンやその他のものを収納するのに使うことができます。

サイズ:310×160×60mm

LONG TERM



スキンセーバー

7401208
90mm
¥3,080(税抜¥2,800)

CONNECTORS



エスケーピストチップキット

7401103
¥5,280(税抜¥4,800)

エスケーピストチップキットはG3が特許を取得しているステンレススチールのコネクターです。どのようなトップ形状のスキーにもしっかりとセット可能です。ペアでの販売になります。



スプリッドボード テールクリップ

7401104
¥4,950(税抜¥4,500)

スプリットボードスキンのテールコネクターです。ストレートなエッジ部分に合わせて容易にセットが可能です。ペアでの販売になります。



NEW

TOPSHEET-MOUNTED TAIL CONNECTORS

Replace the tail connector on your G3 climbing skins with this ultralight and simple accessory to be lighter, faster, and more packable. Weight: 2g ea. Sold as a pair.



テールクリップ (シングル)

7400642
¥2,750(税抜¥2,500)



ツインチップ コネクターキット

7400455
¥3,080(税抜¥2,800)

これまでツインチップのスキー板にシールをしっかりと固定することは難しい問題でしたが、アルピニストスキンのテールストラップにコネクターキットを付け替えることにより、完全に固定することができる画期的なパーツです。



チップ&テールコネクターキット

7401180
¥7,150(税抜¥6,500)
サイズ=S、M、L

各種タイプのクライミングスキン用チップとテール接続キット。S、M、Lで利用可能なチップループが付属しています。



テールコネクターキット

7401181
¥4,620(税抜¥4,200)

あらゆるクライミングスキンに対応するテール接続キットです。

VIA & FIXIE



ISPO AWARD
WINNER
2016/2017

BACKPACKER
EDITOR'S
CHOICE
2021



GEAR
OF THE
YEAR
2021

TRAVERSE GRIP

VIAおよびFIXIEポールの上段の延長グリップは軽量で、ハイクアップ時にグリップ位置を自由に選択できます。素手で使用する際にはポールに対する断熱材の追加レイヤーとして機能し冷たくありません。サイドヒルバンプは、重心の移動が重要となるトラバースなどの技術セクションでの安定性を高めます。

SOFT & LIGHT REMOVABLE STRAP

長さ調整が可能なリストストラップは、利便性と重量が最も重要になります。リストストラップはクリップで接続されておりバックカントリースキーやツリーランのような状況でストラップを簡単に取り外すことができます。そしてフィットしやすい素材が手を包み込んで支え、手のひらに均等に重量を分散します。

RELIABLE CONNECTION

シンプルで使いやすいアルミニウムレバーは硬質鍛造され、ローワーシャフトとアッパーシャフトをより強固に接続します。レバーの位置と構造は枝や障害物が誤ってレバーを開かないようにデザインされています。

ALL-MOUNTAIN BASKET

再設計されたオールマウンテンバスケットは、あらゆる雪の状態に対応するために最適なサイズ（85mm）と形状です。特に急勾配のテクニカルな地形に適しています。素材は最適な剛性感で、滑走中に雪の中でスムーズに動かすこともハイクアップ時にピンディングを操作することもできます。



VIA CARBON ワイアカーボン 7401183
¥28,600 (税抜¥26,000)

軽量かつバックカントリーで必要とされるすべての機能を兼ね備えたツールを探している人向けの最高のカーボンポールです。人間工学に基づき密度の異なる2種類のプラスチックを使用したグリップはより快適性を実現しています。そしてかつてないほど軽量になりました。

Soft and comfortable foam grip with dual density plastic upper for precision

Extended utility tab for binding heel lifts, boot buckles, and more

Upper Shaft: 18 mm Carbon Fibre

Lower Shaft: 16 mm Carbon Fibre

ES/ial	SHORT	LONG
95-125 cm	219 g / 7.7 oz	115-145 cm
		259 g / 9.1 oz



VIA ワイア 7401184
¥17,600 (税抜¥16,000)

軽量で非常に耐久性のあるVIAには、バックカントリーでの使用向けに設計された多機能なポールです。長期間のスキーツアーのような過酷な酷使に耐えるように設計されています。人間工学に基づき密度の異なる2種類のプラスチックを使用したグリップはより快適性を実現しています。

Ergonomic dual density plastic grip shaped for comfort

Quickclick Utility Tab to flick heel lifts or buckles

Upper Shaft: 18 mm 7075 Aluminum

Lower Shaft: 16 mm 7075 Aluminum

ES/ial	SHORT	LONG
Teal 95-125 cm	268 g / 9.5 oz	Navy 115-145 cm
		312 g / 11 oz

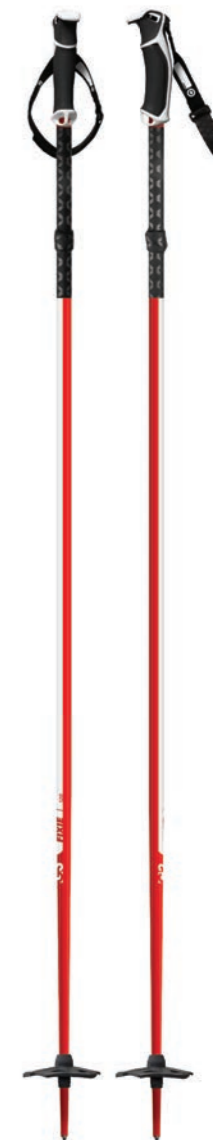

FIXIE フィックス 7401185
¥13,750 (税抜¥12,500)

頑丈なワンピースボールはゲレンデからバックカントリーまで使用できます。シンプルな構造ですがハイクアップと滑走時のパフォーマンスの必要性に合わせて調整された機能が搭載されています。人間工学に基づき密度の異なる2種類のプラスチックを使用したグリップはより快適性を実現しています。

Ergonomic dual density plastic grip shaped for comfort

Quickclick Utility Tab to flick heel lifts or buckles

18 mm Aluminum shaft

ES/ial	SHORT	LONG
115 cm	120 cm	125 cm
130 cm	135 cm	
255 g	267 g	272 g
9 oz	9.4 oz	9.6 oz
		275 g
		9.7 oz
		281 g
		9.9 oz

PIVOT



SECURE PACKING

最高の経験はあらゆるデザインの細部からもたらされます。PIVOTポールは収納時はグリップ周辺に巻き付け、所定の位置にロックすることによって、バックバックへ収納しやすいだけでなく、バックの外側に取付けもし易い構造となっています。スプリットボーダーや荷物を小さくしたいスキーヤー登山者に最適です。

LIGHT & STRONG

PIVOTの軽量アルミニウム構造は、強度と耐久性が十分に発揮されるように設計されています。強力なダウンヒルパフォーマンスが要求される場面では他のフォールディングポールよりも剛性と強度が向上しています。

AN ESSENTIAL PART OF YOUR TOOLKIT

スプリットボーダー特有の、滑走からハイクアップへの移行やビンディングといった行動があります。PIVOTは、グリップ部分にユーティリティタブがあるだけでなく、ヒールリフトを調整するために設計されたバスケットを搭載しています。ユーティリティタブは、手袋の乾燥やテントの張り綱の接続にも利用できます。

GRIP DESIGNED FOR COMFORT & UTILITY

PIVOTは、グリップとハンドリングの精度を高めるために、硬度の異なる2種類のプラスチック製アッパーを備えており、柔らかく快適なフォームグリップも配置されています。上段グリップとシャフトに沿った黄色のリングによりハイクアップする際に握る位置を自由にセッティングできます。ポールを固定する際に引っ張る動作をするだけなので使用までの時間短縮ができます。



PIVOT

ピボット
7401197
¥24,750 (税抜¥22,500)

PIVOTは、優れた収納性と強度を兼ね備えており、スプリットボーダーやバックカントリースキーヤーの為の究極のコンパクトポールです。軽量でコンパクトになる、堅固な折りたたみ式ポール。

Light & strong folding splitboard pole

Upper Shaft: 18 mm 7075 Aluminum

Lower Shafts: 16 mm 7075 Aluminum

SWIAT SHORT	105-125 cm	297 g / 10.5 oz
LONG	115-135 cm	307 g / 10.8 oz

PIVOT TREK

ピボットトレック
7401216
¥28,050 (税抜¥25,500)

優れた収納性と強度を備えた耐久性のある折りたたみ式トレッキングポール。磁気クローザーでコンパクトにロックして、すばやく安全に収納できます。

Light & strong folding trekking pole

Upper Shaft: 18 mm 7075 Aluminum

Lower Shafts: 16 mm 7075 Aluminum

SWIAT SHORT	105-125 cm	287 g / 10.1 oz
LONG	115-135 cm	297 g / 10.5 oz

POLE ACCESSORIES



PIVOT TREK MAGNETIC BASKET

ピボットトレック
マグネティックバスケット 7401217
ペア ¥3,080 (税抜¥2,800)

夏のトレッキング時に使用可能な磁気トレッキングバスケット。切込みのあるバスケットの強力なマグネットによって本体に巻き付けて収納する際にポールの上部にしっかりと巻き付けられコンパクトな収納が可能になります。
*すべてのPIVOTポール21/22以降と互換性があります。



ALL-MOUNTAIN BASKET

オールマウンテンバスケット 7401186
ペア ¥2,420 (税抜¥2,200)

再設計されたオールマウンテンバスケットは、あらゆる雪の状態に対応する最適なサイズ(85mm)と形状です。特に急勾配のテクニカルな地形に適しています。素材は最適な剛性感で、滑走中に雪の中をスムーズ動かすこともハイクアップ時にビンディングを操作することもできます。



POWDER BASKET

パウダーバスケット
7400806
ペア ¥2,420 (税抜¥2,200)



RESORT/TREKKING BASKET

リゾートサイズバスケット
7400805
ペア ¥1,980 (税抜¥1,800)



REPLACEMENT STRAPS

リプレースメントストラップ
7401187
ペア ¥4,400 (税抜¥4,000)

バックアップまたは破損時交換用の軽量で快適なポールストラップです。すべてのG3ポールと互換性があります。



FLEX TIP

フレックスチップ
7400807
ペア ¥2,200 (税抜¥2,000)



POLE LOWER SECTION

ロワーシャフト
カーボン 7401055 (125cm) ¥8,800 (税抜¥8,000)
アルミニウム 7401054 (125cm) ¥7,700 (税抜¥7,000)
7401055 (145cm) ¥8,800 (税抜¥8,000)
7401054 (145cm) ¥7,700 (税抜¥7,000)

SPEED PROBES



SPEED CARBON

スピードカーボン
G3ラインナップの中で最も軽量かつ耐久性の高いプローブです。高強度の3方向から編み込まれたカーボンチューブを使用しています。2サイズから選択できます。

SPEED CARBON 300

7401188 ¥31,350 (税抜¥28,500)
全長=308cm
収納長=52cm
重量=284g
腐食を防ぐコーティングがされたステンレス鋼ケーブル採用。耐久性に優れたケーブルを固定しやすいように、幅広のホールを採用。

SPEED CARBON 240

7401189 ¥26,400 (税抜¥24,000)
全長=248cm
収納長=49cm
重量=220g
使い勝手の良い一般的な長さのプローブ。スピードロックメカニズムは軽量なコードを使用しています。

UPDATED

SPEED

スピード
軽量で信頼性の高いアルミニウム7001-T6チューブは、軽量でありながら信頼性と強度を組み合わせることにより、レクリエーションユーザーや専門家のニーズに応えます。100%テスト済みの高強度アルミニウムを使用。2つのモデルから選べます。

SPEED 320 - NAVY

7401276 ¥19,800 (税抜¥18,000)
全長=324cm
収納長=47cm
重量=335g

SPEED 280 - TEAL

7401277 ¥15,950 (税抜¥14,500)
全長=284cm
収納長=47cm
重量=299g

	OVERALL LENGTH	PACKED LENGTH INCLUDING HANDLE	WEIGHT
SPEED 320	324 cm / 10 ft 8 in	47 cm / 18.5 in*	335 g / 11.8 oz
SPEED 280	284 cm / 9 ft 4 in	47 cm / 18.5 in*	299 g / 10.5 oz
SPEED CARBON 300	308 cm / 10 ft 1 in	52 cm / 20.5 in	284 g / 10.0 oz
SPEED CARBON 240	248 cm / 8 ft 2 in	49 cm / 19.3 in*	220 g / 7.7 oz

*SHORTER SEGMENTS MAKE THESE PROBES IDEAL FOR DAYPACKS

AVI & SPADE SHOVELS



AVI

「アヴィ」はバックカントリーでの緊急事態に備えて信頼性の高いツールを必要とする人に最適です。様々なニーズに対応した使いやすいギアです。強力なDグリップまたは軽量のTグリップハンドルの2種類があります。
・高耐久性
・滑りにくいシャフトグリップにより、除雪がより速く快適になります
・スノービットチェックに有効な平らなブレード表面。
・伸縮シャフト
・レスキュースレッド作成のためのスロット穴付きブレード

アビショベル [Dグリップ]

7401192 ¥15,180 (税抜¥13,800)
重量=770g/全長=66~86cm テレスコーピング
ブレードサイズ:24.0×26.5cm

アビショベル [Tグリップ]

7401193 ¥15,180 (税抜¥13,800)
重量=730g/全長=60~80cm テレスコーピング
ブレードサイズ:24.0×26.5cm

エクステンションシャフト

7400009 ¥2,970 (税抜¥2,700)
一段目シャフトのパーツです。

アビブレード

7400010 ¥7,150 (税抜¥6,500)
ブレードサイズ=24.0×26.5cm
ブレードだけのパーツです。



SPADE

コンパクトで軽量な「スパード」。SPADEの丸みを帯びた先端、コンパクトなブレードデザイン、Tグリップハンドルを採用。
・ブレード部分の丸みを帯びた先端は、硬い雪を簡単に砕くことができます。
・滑りにくいシャフトグリップにより、除雪がより速く快適になります。
・パッキングが容易な薄型のブレード。
・高強度。
・伸縮シャフト採用。

スパードショベル [Tグリップ]

7401195 ¥12,980 (税抜¥11,800)
重量=630g
全長=57~79cm テレスコーピング
ブレードサイズ=20.5×25.0cm

スパードショベル [Dグリップ]

7401194 ¥12,980 (税抜¥11,800)
重量=670g
全長=63~85cm テレスコーピング
ブレードサイズ=20.5×25.0cm

スパードブレード

7400267 ¥8,250 (税抜¥7,500)
ブレードサイズ=20.5×25.0cm
ブレードだけのパーツです。



シャフトアッセンブリ (T)
7400270 ¥3,850 (税抜¥3,500)
シャフト上部Tグリップパーツです。

シャフトアッセンブリ (D)
7400269 ¥3,850 (税抜¥3,500)
シャフト上部Dグリップパーツです。



スパードショベルは軽量で剣先スコップに近い形状のため(左)、春先の締まった雪や、硬いデブリの掘り出しに適しています。アビテックショベルはブレード背面が他に類をみないほど平らに設計されている大きめの角形ブレードが特徴。スノービットでの積雪観察や雪洞づくり、デブリの掘り出し等、作業効率求められるシチュエーションに最適です。

BONESAW & CORD

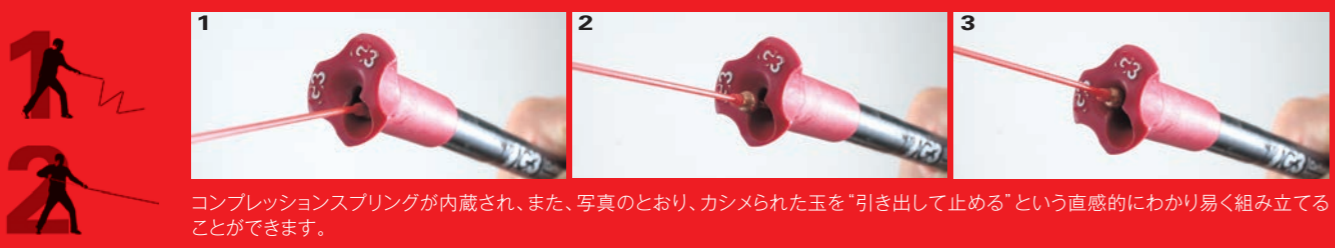

コンプレッションスプリングが内蔵され、また、写真のとおり、カシメられた玉を“引き出して止める”という直感的にわかり易く組み立てることができます。



BONESAW

7401196 ¥12,650 (税抜¥11,500)
「ボーンソー」は完璧なスノーソーで軽量で耐久性に優れています。骨、木、氷を切り裂くのに十分な強度をもっています。スキーポールやショベルシャフトに取り付けるためのスロットがあります。軽量な鞘と400mmテンションストラップが付属しています。
TOTAL LENGTH 47 cm / 18 in
CUTTING LENGTH 35 cm / 14 in
169 g / 5.9 oz
Hardened stainless steel



RUTSCHBLOCK CORD

ルッチブロックコード
7400012 ¥5,940 (税抜¥5,400)
プローブを2本使用すれば素早くルッチブロック用雪柱を切り出すことのできる雪用ワイヤーソーです。
5.75 m / 18 ft 10 in
Coated stainless steel cable

LOGO GEAR

PREMIUM GEAR FOCUSED ON USERS

Experience the backcountry in style with quality softgoods and accessories from G3. We focus on the G3 customer when we develop any new item in our logo gear program. Every decision is driven from the idea of what is useful for them either on the mountain or off. It's the little things you'll enjoy even after you come home from a long tour.



MERINOTOQUE

This ultra fine knit merino toque helps regulate your body temperature on a ski tour or simply looks great on a cold day in town. Can be worn cuffed or unrolled, with a woven label at side.

Fine merino wool
2 colours available: Teal, Grey



TOURING CAP

This microfibre 5 panel features mesh side panels and a moisture wicking sweatband to cool you off when you are working hard, and the soft brim makes it easy to stash in your pack when not in use.

Microfibre polyester



CANADA TRUCKER

Classic trucker cap style built with the quality and fit you expect from G3. This midpro shaped hat with a precurved visor and snapback closure is equally at home in the backcountry as it is at the bar.

Cotton-Poly/Nylon Mesh
3 colours available: Red, Grey, Navy



SKI SOCKS

Keep your feet warm, dry and comfortable in the most demanding conditions with these lightweight 12" cuff height socks. TurboWool blend base is 5x stronger than merino wool alone. Shrink-resistant for long-lasting quality. S/M & L/XL Stretch-to-Fit sizing system for a perfect fit on a wide range of foot sizes.



HIKE SOCKS

Sometimes we go outside without our skis. These 6" cuff height socks will feel great when you put them on, then disappear for the rest of the day. TurboWool blend base is 5x stronger than merino wool alone. Shrink-resistant for long-lasting quality. S/M & L/XL Stretch-to-Fit sizing system for a perfect fit on a wide range of foot sizes.



220 レッド



563 ティール

670 ネイビー

NECK GAITER

サイズ:onesize
7401105 ¥2,530(税抜¥2,300)

体温を一定に保ち、紫外線をカットします。そしてG3らしいデザインをしています。G3のクライミングスキンをフューチャーしたデザインであなたのスキーツアーの素晴らしい相棒になるでしょう。



VINYL DIE-CUT LOGO STICKERS

Simple stickers that have a big impact. These die-cut vinyl stickers showcase the G3 logo anywhere you want to stick it.

2 sizes: 12.5 cm / 5 in, 6.2 cm / 2.5 in
2 colours: Red, White



WHITE ON RED LOGO STICKER

Updated to be as clean and simple as possible to reflect the modern G3 brand, these vinyl stickers are a great way to show your backcountry roots on all your other gear.

6.2 cm / 2.5 in
White logo on red sticker

PARTS

We have a full assortment of parts to support shops and end users alike. Check our B2B portal, Hubsoft, for a complete listing.

- Be prepared to deliver top-notch customer service: have a small selection of binding, pole, and snow tool parts on hand to help your customers when they need it
- Our outstanding G3 customer service team is available to make recommendations to suit your needs.



CATEGORY	SKU	UPC	DESCRIPTION
Parts - ZED Toe	8183	687040022577	ZED 9 Complete Toe assembly (Black)
Parts - ZED Toe	8692	687040027053	ZED 12 Complete Toe assembly (Black)
Parts - ZED Toe	8134	687040029866	ZED 12 Toe Shim (Black)
Parts - ZED Toe	7966	687040021815	ZED 9 & 12 Toe Mode Lever Assembly (Grey - old)
Parts - ZED Toe	7265	687040021822	ZED 9 & 12 Toe Mode Lever Pin
Parts - ZED Heel and Brake	8184	687040022584	ZED 9 Heel Turret Assembly (Black)
Parts - ZED Heel and Brake	8748	687040027329	ZED 12 Heel Turret Assembly (Black)
Parts - ZED Heel and Brake	8135	687040029767	ZED 9 & 12 Heel Mounting Track (Black)
Parts - ZED Heel and Brake	8136	687040029842	ZED 9 & 12 Track Shim (Black)
Parts - ZED Heel and Brake	8693	687040029859	ZED 9 & 12 Brake SPACER (Black)
Parts - ZED Heel and Brake	7283	687040031944	ZED 9 & 12 Heel Lift (Green)
Parts - ZED Heel and Brake	8047	687040029873	ZED 9 & 12 Updated/Stiffer Forward Pressure Spring
Parts - ION Toe	8710	687040029804	ION 10 Complete Toe Assembly w/ Bootstp (Black)
Parts - ION Toe	8709	687040029798	ION 12 Complete Toe Assembly w/ Bootstop (Black)
Parts - ION Toe	5451	687040024281	ION 10 & 12 Toe Mode Lever Assembly (Black/Orange)
Parts - ION Toe	4709	687040031968	ION 10 & 12 Toe Mode Lever Pin
Parts - ION Toe	5003	687040022270	ION 10 & 12 Plastic Toe Shim (Black)
Parts - ION Heel and Brake	8727	687040029774	ION 10 Heel Turret Assy (Black)
Parts - ION Heel and Brake	8728	687040029781	ION 12 Heel Turret Assy (Black)
Parts - ION Heel and Brake	8991	687040029552	ION Baseplate w/Brake Assmly BLK 85mm - No turret 85mm
Parts - ION Heel and Brake	8992	687040029545	ION Baseplate w/Brake Assmly BLK 100mm - No turret 100mm
Parts - ION Heel and Brake	8993	687040029569	ION Baseplate w/Brake Assmly BLK 115mm - No turret 115mm
Parts - ION Heel and Brake	8994	687040029576	ION Baseplate w/Brake Assmly BLK 130mm - No turret 130mm
Parts - ION Heel and Brake	5440	687040029835	ION 10 & 12 Brake Cover (Black)
Parts - ION Heel and Brake	4916	687040022256	ION 10 & 12 Brake Spring Cover (Dark Grey)
Parts - ION Heel and Brake	5495	687040031951	ION 10 & 12 Heel Lift (Orange)

CATEGORY	SKU	UPC	DESCRIPTION
Parts - ION Heel and Brake	5835	687040013544	ION 10 & 12 AFD Repair Kit
Parts - ION DEMO Heel and Brake	8995	687040029583	ION DEMO Baseplate w/B Assembly BLK 85mm - No turret 85mm
Parts - ION DEMO Heel and Brake	8996	687040029590	ION DEMO Baseplate w/B Assembly BLK 100mm - No turret 100mm
Parts - ION DEMO Heel and Brake	8997	687040029606	ION DEMO Baseplate w/B Assembly BLK 115mm - No turret 115mm
Parts - ION DEMO Heel and Brake	8998	687040029613	ION DEMO Baseplate w/B Assembly BLK 130mm - No turret 130mm
Parts - Mounting Screw Kits	8705	687040027060	ION 10 & 12/ZED 9 Toe - Mounting Screws (8 pcs)
Parts - Mounting Screw Kits	8708	687040027091	ION 10 & 12 Heel - Mounting Screws (8 pcs)
Parts - Mounting Screw Kits	5461	687040009721	ION 10 & 12 DEMO Heel - Mounting Screws (8 pcs)
Parts - Mounting Screw Kits	8707	687040027084	ZED 9 Heel/ZED 12 Toe & Heel/ZED DEMO - Mounting Screws (8 pcs)
Parts - Other	5060	687040008540	ION/ZED Crampon Adaptor Kit
Parts - Pole Parts	6254	687040026414	Pole Clamp Arm & Nut
Parts - Pole Parts	6257	687040024274	Pole Clamp Body
Parts - Pole Parts	5028	687040008410	Flex Tips
Parts - Pole Parts	8351	687040023437	Wrist Straps
Parts - Pole Parts	8424	687040024038	Via Aluminum Lower Shaft - Long (Navy)
Parts - Pole Parts	8423	687040024021	Via Aluminum Lower Shaft - Short (Teal)
Parts - Pole Parts	8428	687040024076	Via Aluminum Upper Shaft - Long (Navy)
Parts - Pole Parts	8427	687040024069	Via Aluminum Upper Shaft - Short (Teal)
Parts - Pole Parts	8422	687040024014	Via Carbon Lower Shaft - Long
Parts - Pole Parts	8421	687040024007	Via Carbon Lower Shaft - Short
Parts - Pole Parts	8426	687040024052	Via Carbon Upper Shaft - Long
Parts - Pole Parts	8425	687040024045	Via Carbon Upper Shaft - Short
Parts - Snow Tool Parts	562	876129001811	1 Button Shovel Snap
Parts - Snow Tool Parts	563	876129001828	2 Button Shovel Snap
Parts - Snow Tool Parts	8201	687040022607	AviTECH Shovel Blade (Navy)
Parts - Snow Tool Parts	8203	687040026391	D Grip Shovel Shaft Assembly (Navy)
Parts - Snow Tool Parts	8204	687040026407	D Grip Shovel Shaft Assembly (Teal)
Parts - Snow Tool Parts	8202	687040022621	SpadeTECH Shovel Blade (Teal)
Parts - Snow Tool Parts	8205	687040024359	T Grip Shovel Shaft Assembly (Navy)
Parts - Snow Tool Parts	8206	687040024366	T Grip Shovel Shaft Assembly (Teal)



2023 | 2024
WORKBOOK
WINTER

—
NO SHORTCUTS



PROUD PARTNERS

SCOTT SPORTS is proud to be named as Official Premium Partner of the Freeride World Tour

"The FWT is the worldwide circuit of freeride snowboarding and skiing with the best riders in the world competing on the most legendary and challenging alpine faces at the most renowned ski resorts across the world." – Freeride World Tour



FWT STOPS

- KICKING HORSE GOLDEN BC – CANADA, JAN. 2023
- BAQUEIRA BERET – SPAIN, JAN. 2023
- ORDINO ARCALIS – ADORRA, FEB. 2023
- SAALBACH FIEBERBRUNN – AUSTRIA, MAR. 2023
- VERBIER – SWITZERLAND, MAR. 2023



VALENTIN RAINER
2022

FREERIDE WORLD TOUR OFFICIAL SAFETY PARTNER

WE SUPPORT THE ORGANIZATION IN MAKING THE TOUR A SUCCESS AND EQUIP THE STAFF WITH OUR HELMETS AND BACK PROTECTOR SAFETY PRODUCTS.



SCOTT SYMBOL 2 PLUS D
FREERIDE WORLD TOUR OFFICIAL HELMET

- ISPO Award Gold Winner
- D3O® absorbs all types of impacts
- MIPS® Brain Protection System
- 360° P.S. ear pads: better hearing
- Dual active venting system
- RAS Fit System: for all heads
- Include icons and logo



SCOTT AIRFLEX MEN'S POLAR VEST PROTECTOR
FREERIDE WORLD TOUR OFFICIAL PROTECTOR

- Level 1 protection
- AirFlex technology with D3O®
- Excellent warmth-to-weight ratio
- Strapless vest design
- Full front zip
- Polartec® Power Grid™ fabric





OUR ATHLETES COMPETING ON THE FWT 2023

FOR 2023, OUR ATHLETES WILL BE WEARING:

- SYMBOL 2 PLUS D HELMET
- SRS PROGUIDE POLES
- REACT GOGGLE
- PATROL E2 AVALANCHE BACKPACK



FREERIDE WORLD TOUR OFFICIAL GOGGLE

As the official goggle sponsor, we are proud that all the Freeride World Tour teams will be wearing our goggles to protect their eyes in the most extreme conditions. This is a real mark of confidence and testament to the quality of our technical products.



CARL REGNER (SWE)

2nd FWT 2022 Overall Men's Skiing



VALENTIN RAINER (AT)

2nd FWQ 2022 Overall Men's Skiing



MOLLY ARMANINO (US)

1st FWQ 2022 Women's Skiing Kicking Horse IFSA FWQ 4*

1st FWQ 2022 Women's Skiing Crystal Mountain IFSA 4* FWQ Final



27 TONS OF CO²
COMPENSATED FOR OUR
ATHLETE'S TRAVEL WITH
ALMIGHTY TREE.

re source by SCOTT

Re-source by SCOTT is an important step for us in becoming a responsible steward of our planet and society. We look forward to improving our practices in each of these fields.

PEOPLE

We consider that all people involved in our supply chain should be treated fairly with dignity and respect.

PLANET

We take into consideration that the earth's resources must be used in such a way that ecosystems and future generations shouldn't be adversely affected.

PRODUCTS

We aim to maximize the sustainable nature of our products while still maintaining their high level of performance through innovation, technology and design.

SUSTAINABLE DEVELOPMENT GOALS



Reduced Inequalities



Clean water & sanitation



Sustainable cities & communities



Partnership for the goals



Responsible consumption & production



Decent work & economic growth



Climate action

WHAT IS RE-SOURCE BY SCOTT FOR HARDGOODS

Re-source by SCOTT hardgoods products are defined by the use of recycled, bio-based and/or renewable materials certified by third-parties, representing a minimum of 50% more eco-responsible materials by weight.



COULOIR TOUR

A lightweight, touring-specific winter helmet used by our most winter athletes. Designed to work with a beanie, this helmet is made with over 55% recycled material. The EPS, straps and vent plates are all made using recycled waste. This helmet keeps you safe and helps lessen our impacts on our playground.



SHIELD RECYCLED

The ISPO award winning goggle is back. The success of the used goggle collection campaign has enabled us to provide this groundbreaking product for a second season.



COSMOS RE-SOURCE

This first foray in using more ECO responsible materials in our skiboots has enabled us to add another product in the re-source by SCOTT family. With a mixture of biobased and recycled materials reaching 50% of the product weight. The COSMOS ECO is a great first step towards the future.

SIZE CHART SKIS

Ski selection is a very subjective and personal decision. It's determined according to the usage, the weight, the height, the skiing style and the physical ability of the skier.

	TOURING	ALL MOUNTAIN (<90MM)	FREERIDE (>90MM)
BEGINNER	YOUR HEIGHT - 10 CM	YOUR HEIGHT - 15 CM	YOUR HEIGHT - 5 CM
INTERMEDIATE	YOUR HEIGHT - 7 CM	YOUR HEIGHT - 10 CM	YOUR HEIGHT
EXPERIENCED	YOUR HEIGHT - 5 CM	YOUR HEIGHT - 5 CM	YOUR HEIGHT
EXPERT	YOUR HEIGHT	YOUR HEIGHT	YOUR HEIGHT + 5 CM

SIZE CHART BOOTS

How to know your foot size in mondo size?

- Put two sheets of paper against a wall and take a pencil.
- Place your feet on the sheets of paper with your heel touching the wall.
- Make sure your feet are naturally spaced, i.e. the same width as your hips.
- Bend your knees slightly and outline your toes with a pencil.
- Take the longest measurement in centimetres and transfer it to the size chart.

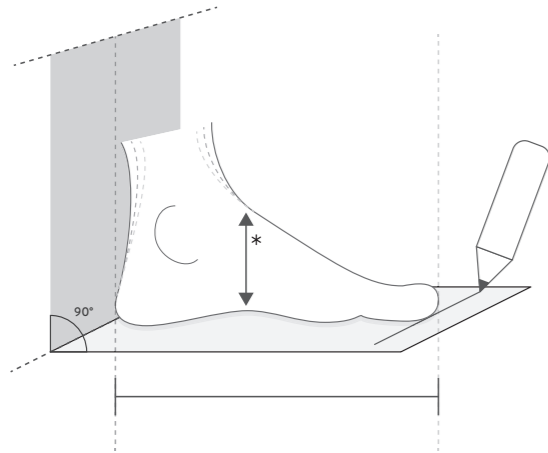

MEASUREMENT IN CM		RECOMMENDATION IN MONDO SIZE
FROM	TO	
23	23,4	23
23,5	23,9	23,5
24	24,4	24
24,5	24,9	24,5
25	25,4	25
25,5	25,9	25,5
26	26,4	26
26,5	26,9	26,5
27	27,4	27
27,5	27,9	27,5
28	28,4	28
28,5	28,9	28,5
29	29,4	29
29,5	29,9	29,5
30	30,4	30
30,5	30,9	30,5
31	31,4	31
31,5	31,9	31,5

NB:

If you have a low instep, always take the rounded size.
Example: My feet measure 27.8 cm and I have a low instep: I will choose size 27.0.

If you have a high instep, always take the half size.
Example: My feet measure 27.2 cm and I have a high instep: I will choose size 27.5.

*instep height

SIZE CHART POLES

For Touring we recommend the usage of telescopic pole. For Freestyle, we recommend -10 to -20cm of the recommended size. Your pole size might change according to your ski style and your body geometry.

SKIERS HEIGHT (CM)	CM	IN
100	70	27"
105	75	29"
110	75	29"
115	80	31"
120	80	31"
125	85	33"
130	90	35"
135	90	35"
140	95	37"
145	95	37"
150	100	39"
155	105	41"
160	105	41"
165	110	43"
170	110	43"
175	115	45"
180	120	47"
185	125	49"
190	130	51"
195	135	53"
200	140	55"

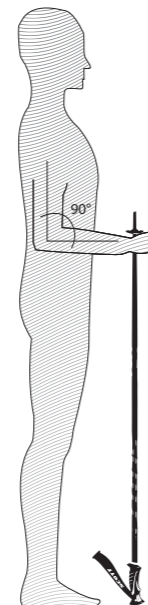

SIZE CHART PROTECTION

MEN: level 1 - Airflex

INTERNATIONAL	S	M	L	XL	
GERMANY	44/46	46/48	50/52	54/56	SCOTT AIRFLEX LIGHT MEN'S VEST PROTECTOR SCOTT AIRFLEX POLAR MEN'S VEST PROTECTOR SCOTT RENTAL ULTIMATE MEN'S VEST PROTECTOR
UK	34/36	36/38	40/42	44/46	
FRANCE	38	40	42	44	
③ HEIGHT (CM)	< 170	170-180	180-185	> 185	LEVEL 1 ACCORDING TO EN 1621-2:2014
① TORSO LENGTH (CM)	35-40	39-44	42-47	44-49	
④ CHEST (CM)	92-96	96-102	102-106	109-114	
② WAIST (CM)	74-79	79-84	92-96	98-104	

WOMEN: level 1 - Airflex

INTERNATIONAL	S	M	L	XL	
GERMANY	36/38	38/40	40/42	42/44	SCOTT AIRFLEX LIGHT WOMEN'S VEST PROTECTOR SCOTT AIRFLEX POLAR WOMEN'S VEST PROTECTOR SCOTT RENTAL ULTIMATE WOMEN'S VEST PROTECTOR
UK	8/10	10/12	12/14	14/16	
FRANCE	38	40	42	44	
③ HEIGHT (CM)	< 165	165-170	170-175	> 175	LEVEL 1 ACCORDING TO EN 1621-2:2014
① TORSO LENGTH (CM)	35-40	35-40	39-44	42-47	
④ CHEST (CM)	84-89	89-94	94-100	100-106	
② WAIST (CM)	65-70	70-75	75-80	80-85	

UNISEX: level 1 - Airflex

INTERNATIONAL	XXS	XS	S	M	L	XL	
③ HEIGHT (CM)	-	< 165	165 - 170	170-180	180-185	> 185	SCOTT AIRFLEX BACK PROTECTOR
① TORSO LENGTH (CM)	-	35-40	35-40	39-44	42-47	44-49	LEVEL 1 ACCORDING TO EN 1621-2:2014
INTERNATIONAL	XXS	XS	S	M	L	XL	
③ HEIGHT (CM)	< 140	140-165	165 - 170	170-180	180-185	> 185	SCOTT RENTAL ACTIVE BACK PROTECTOR
① TORSO LENGTH (CM)	31-35	35-40	35-40	39-44	42-47	44-49	LEVEL 1 ACCORDING TO EN 1621-2:2014

YOUTH: level 1 - Airflex

INTERNATIONAL	XXS	XS	S	M	
AGE	4-7	7-9	9-11	11-13	SCOTT AIRFLEX JUNIOR VEST PROTECTOR
③ HEIGHT (CM)	110-124	124-140	140-155	155-170	
① TORSO LENGTH (CM)	28-31	31-35	35-40	39-44	
④ CHEST (CM)	57-61	61-65	67-71	71-75	
② WAIST (CM)	54-57	57-59	60-62	63-65	LEVEL 1 ACCORDING TO EN 1621-2:2014
INTERNATIONAL	XXS	XS	S	M	
③ HEIGHT (CM)	110-124	124-140	140-155	155-170	SCOTT AIRFLEX JUNIOR BACK PROTECTOR
① TORSO LENGTH (CM)	28-31	31-35	35-40	39-44	LEVEL 1 ACCORDING TO EN 1621-2:2014

SIZE CHART PROTECTION

MEN: level 2 - AirFlex pro

INTERNATIONAL	S	M	L	XL
GERMANY	44/46	46/48	50/52	54/56
UK	34/36	36/38	40/42	44/46
FRANCE	38	40	42	44
③ HEIGHT (CM)	< 170	170-180	180-185	> 185
① TORSO LENGTH (CM)	39-44	39-44	42-47	44-49
④ CHEST (CM)	92-96	96-102	102-106	109-114
② WAIST (CM)	74-79	79-84	92-96	98-104

SCOTT AIRFLEX PRO MEN'S VEST PROTECTOR

LEVEL 2 ACCORDING TO EN 1621-2 :2014

UNISEX: level 2 - AirFlex pro

INTERNATIONAL	S/M	L/XL	XL/2XL
③ HEIGHT (CM)	< 170	170-185	> 185
① TORSO LENGTH (CM)	39-44	42-47	44-49

SCOTT AIRFLEX PRO BACK PROTECTOR

LEVEL 2 ACCORDING TO EN 1621-2 :2014

LOWER BODY: UNISEX

INTERNATIONAL	S/M	L/XL	XL/2XL
② WAIST (CM)	74-79	79-84	84-89

SCOTT AIRFLEX SHORT PROTECTOR

LEVEL 1 ACCORDING TO EN 1621-1 2012

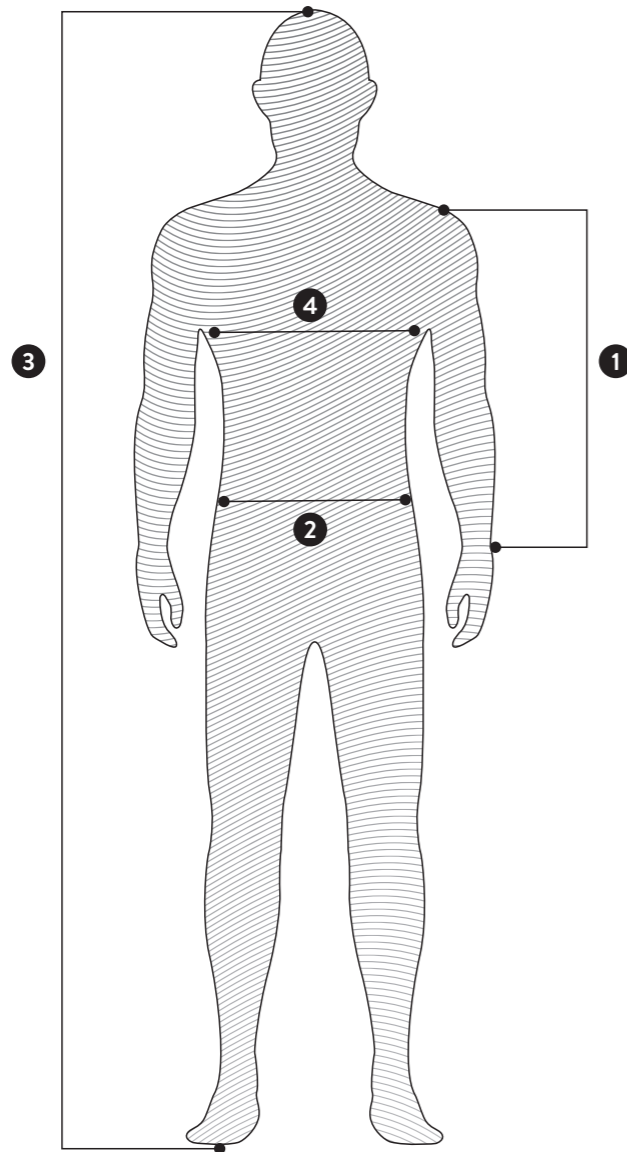

SIZE CHART HELMET

MODEL	STANDARD	XS	S	M	L	
SCOTT COULOIR MOUNTAIN SCOTT COULOIR TOUR SCOTT BLEND PLUS / BLEND PLUS LS SCOTT SYMBOL 2 / SYMBOL 2 PLUS D SCOTT CHASE 2 / CHASE 2 PLUS SCOTT TRACK / TRACK PLUS	EN12492:2012 (Coulair Mountain only) EN1077: 2007 / CLASS B		51-55	55-59	59-61	CM
SCOTT KEEPER 2 / KEEPER 2 PLUS	EN1077: 2007 / CLASS B		20-21.6	21.6-23.2	23.2-24	INCHES
SCOTT RENTAL ACTIVE / ULTIMATE	EN1077: 2007 / CLASS B	49-53 19.2-20.8	53-56 20.8-22	56-59 22-23.3	59-61 23.2-24	CM INCHES

SIZE CHART GOGGLES

	LCG EVO	LCG COMPACT	VAPOR	LINX	FAZE II	REACT	SHIELD	FACTOR	SPHERE OTG	UNLIMITED II OTG	MUSE PRO OTG	WITTY JR	AGENT JR
	SPHERICAL					CYLINDRICAL			OTG	JUNIOR			
M - L	■		■		■	■	■		■	■			
S - M		■		■				■			■		
XS - S												■	
XXS - XS													■

SIZE CHART BACKPACKS

USA	XS	S	M	L	XL	XXL	MEN
BODY HEIGHT	168-174	171-179	174-182	177-185	180-188	183-191	CM
	-	-	-	-	-	-	INCHES
CHEST	86-92	92-96	96-102	102-108	108-114	114-121	CM
	34-36	36-38	38-40	40-42,5	42,5-45	45-47,5	INCHES
WAIST	71-76	76-81	81-86,5	86,5-91,5	91,5-99	99-106,5	CM
	28-30	30-32	32-34	34-36	36-39	39-42	INCHES
HIP	86,5-91,5	91,5-96,5	96,5-101,5	101,5-106,5	106,5-111,5	111,5-117	CM
	34-36	36-38	38-40	40-42	42-44	44-46	INCHES
PATROL E1 22 / SL PATROL E1 30 / NL+SL PATROL ULTRALIGHT E2 25 / NL	SL - SHORT BACK LENGTH						
PATROL E2 22 / SL PATROL E2 38 / NL GUIDE AP 20 / SL MOUNTAIN 25 / SL MOUNTAIN 35 / NL	NL - NORMAL BACK LENGTH						

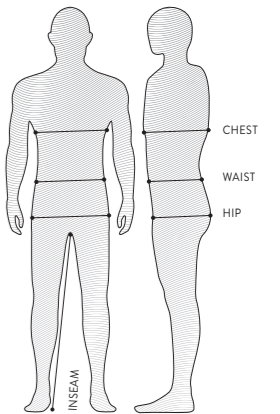

USA	EU-XS / US-XXS-0	EU-S / US-XS-2	EU-M / US-S-4/6	EU-L / US-M-8/10	EU-XL / US-L-12	EU-XXL / US-XL-14	WOMEN
BODY HEIGHT	160-166	163-169	166-172	169-175	172-178	175-181	CM
	-	-	-	-	-	-	INCHES
CHEST	79-84	84-89	89-94	94-100	100-106	106-113	CM
	31-33	33-35	35-37	37-39,5	39,5-42	42-44,5	INCHES
WAIST	61-66	66-71	71-78	79-85	85-91,5	91,5-98	CM
	24-26	26-28	28-30	31-33,5	33,5-36	36-38,5	INCHES
HIP	86-91	91-96	96-102	102-107	107-113	113-119	CM
	34-36	36-38	38-40	40-42	42-44,5	44,5-47	INCHES
PATROL E1 22 / SL PATROL E1 30 / NL+SL PATROL ULTRALIGHT E2 25 / NL	SL - SHORT BACK LENGTH						
PATROL E2 22 / SL PATROL E2 38 / NL SCOTT GUIDE AP 20 / SL MOUNTAIN 25 / SL MOUNTAIN 35 / NL	NL - NORMAL BACK LENGTH						

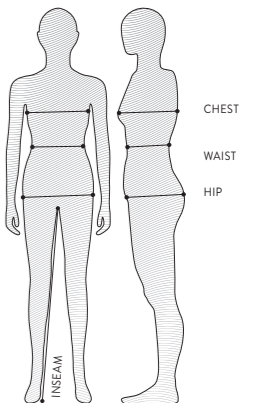

GLOSSARY

SKIS



3DIMENSION SIDECUT
This revolutionary sidecut design combines a tip and tail radius with either a central flat line or a small amount of sidecut underfoot. The tip and tail radii allow for easy turn initiation while the flat line (freeride) or a larger radius (all conditions) provides stability, power and precise edge hold. This proven design has earned accolades in the form of multiple ski test awards. * 3Dimension Touring Sidecut now available for a better touring tuning.



3DIMENSION SIDECUT
The new 3Dimensional Touring Sidecut is a revolutionary design for a better touring tuning that combines a tip and tail radius with either a central flat line or a small amount of sidecut underfoot. The tip and tail radii allow for easy turn initiation while the flat line or a larger radius provides stability, power and precise edge hold. In addition to the new 3Dimension Touring sidecut our established 3Dimension Sidecut increases the skiability and performance in our freeride skis. In addition to the new 3Dimension Touring sidecut our established 3Dimension Sidecut increases the skiability and performance in our freeride skis.



DUAL LIGHT CORE
The Dual Light Core features a new paulownia/ beech wood core that ensures a stable, strong and well-dampened ride.



PURE FREERIDE SIDECUT
Inspired by Jérémie, the new Pure Freeride Sidecut provides both stability and maneuverability. A shorter radius at the front than at the back with a long radius underfoot make the ski agile in any conditions.



AIR TEC
Air Tec technology reduces weight by removing material where it is least needed. The grooves along the base side of the wood core make the ski 10% lighter while maintaining its full performance and agility.



RE-SOURCE
At SCOTT, we believe of doing things the right way and for the right reasons. We are committed to improving the impacts of our products and business practices, preserving the environment for future generations and stimulating positive change in our communities.



TITANAL REINFORCEMENT
Stability and performance are key on compact snow when grip and confidence in the skis are pushed to the limit. The titanal reinforcement makes the push on the edges quicker and more precise. The SCOTT titanal reinforcement has a unique shape depending on the ski model so as not to compromise the natural flex and ski rebound.



FULL SKI LENGTH WOOD CORE
The Full-Length Wood Core produces a more consistent ski flex and creates a homogeneous transition between the middle part and the rockered tip and tail.



FACTORY FINISH
SCOTT skis come direct from the factory ready to ski with SCOTT's Factory Finish. Factory Finish offers an effective edge angle of 88°, resulting from a 3° side and 1° base angle for an exceptional performance. The base is finished with a micro structured CNC stone grind so you can mount your skis and hit the hill, no tuning required.



REINFORCED STEEL EDGE
SCOTT freestyle skis use a durable, oversized-height steel edge. This Reinforced Steel Edge is far more resistant to breaking.



RENTAL TOP SHEET
The Rental Top Sheet minimizes the contact with the foil top by using little hole patterns to disperse potential scratches and abrasions. The result is increased durability, ideal for rental shop use.



SKIN FIXATION SYSTEM
The SCOTT Skin Fixation System ensures easy and fast skin attachment in all weather conditions.

BOOTS



ADJUSTABLE FORWARD LEAN
The new Adjustable Forward Lean technology is a step forward in versatility and flexibility on the mountain. Switching the heel walking clip on the back of the ski boot results in an increased forward lean of up to 15.



CABRIO / HYBRID CONSTRUCTION
The newly developed Cabrio/Hybrid Construction is a revolutionary boot design that takes the best features from a classic cabrio design boot and a classic overlap ski boot. The result is a design with a lower shell and a pivot point that enables quick and powerful edge-to-edge movement when skiing and agile flex characteristics while ascending the mountain. The Cabrio/Hybrid construction is paramount for a powerefficient and versatile skiing style.



SCOPE ACTION TONGUE
The newly developed Dual-Action Tongue allows an easy step in and out of the boot. Due to the flexibility of the tongue, it follows the movement when in walk mode and is fully linked to the cuff when skiing, which results in a more progressive flex.



THERMO LINER
The Thermo Liner is pre-fit for an instant sensation of precision and comfort. It's also possible to thermo form the liner to your feet for even more precision and comfort. Made from lightweight and warm material, the liner increases mobility and breathability.



CARBON FIBER REINFORCEMENT
The shell is reinforced with carbon fibers to have a better and faster effort transmission when skiing downhill. The carbon make also the boots lighter for more comfort and performance on the way up.



TELEMARK POWERTOUR
The telemark boots are developed with an ample forefoot and a secure heel. The multi-injected internal pod was developed with cutouts to give relief to the vulnerable areas on the telemarker's feet.



POWERLITE 2.0
Shells were developed around the foot for a custom boot fitter fit right out of the box. Their molds are reshaped to provide more room for the first metatarsal, the sixth toe, the navicular bone, and asymmetric malleoli that match the body's natural asymmetry, and to provide a deep, supportive heel cup with space for common heel spurs. Toewidth and height have been increased for an even more comfortable fit.



POWERLITE DUAL TONGUE
Tongues are dual-injected in different densities of material so that they seal against the shell to keep snow and water out, and offer a better flex in ski and walk mode.



SKI/WALK SECURITY LEVER
Easy to operate, the SKI/WALK SECURITY LEVER rear hook mechanism combines strength and stability in ski mode with total freedom when skinning or walking. This generation of hook mechanism add a secondary locker to the lever while downhill skiing for extra safety.



TELEMARK NTN NORM



TELEMARK 75MM NORM



INTEGRATED SKI/WALK MECHANISM
Easy to operate, the integrated rear mechanism combines strength and stability by blocking the cuff in ski mode, with total freedom when skinning or walking.



CERTIFIED DYNAFIT® INSERTS
SCOTT ski touring boots use certified Dynafit® tech inserts for consistent quality, security, and compatibility with tech bindings.



GRIPWALK®
The all-new GripWalk® rubber sole is a distinctive touring and mountaineering ski boot feature. The thin but robust rubber accomplishes precise movements on any terrain.



VIBRAM OUTSOLE
The Vibram outsole ensures maximum grip when scrambling over any terrain that isn't snow. The Vibram composition provides durability and superior edging power while giving maximum grip for scrambling.

POLES



S4
SCOTT aluminum ski poles undergo an electrostatic paint process, delivering a clean, contemporary, highly durable finish. They are constructed with the strongest aircraft-grade aluminum-zinc alloy commercially available, which has been heat treated and aged in order to confer its excellent properties. S4 aluminum poles are twice as strong as the industry standard and possess a very high strength-to-weight ratio. *According to ISO 7337-11



S3
S3 aluminum shafts are computer engineered and manufactured with high-grade aluminum. This magnesium aluminum alloy has been strain hardened to confer high strength and good resistance. *According to ISO 7337-11



S2
S2 aluminum shafts utilize the same technical swaging and design features found in the S4 and S3 series and are rated to 45 000 PSI. *According to ISO 7337-11



SC
SCOTT uses Carbon Construction as it's a strong yet lightweight material that never sacrifices performance. Light, stiff, with unmatched performance, Carbon Construction is used in SCOTT skis, poles and boots because there are no shortcuts to building a better product.



SCOTT S.R.S. - STRAP RELEASE SYSTEM
The SCOTT S.R.S. is the next generation of safety technology in ski poles. The S.R.S. allows the strap to release from the grip of the pole in sketchy situations to prevent injury.

- + Releases quickly while pulling sharply upwards
- + Integrated system for best wearing comfort
- + Safety anywhere and anytime

HELMETS



MIPS (MULTI-DIRECTIONAL IMPACT PROTECTION SYSTEM)
Improved protection on angled impacts, reduces the rotational violence transmitted to the brain.



LIGHTWEIGHT
During the in-mold manufacturing process, the outer shell of polycarbonate material is fused with the helmet's impact-absorbent foam liner, creating a super-lightweight outer shell. With reduced weight and bulk surrounding the head, in-mold helmets are more comfortable than traditional helmets.



ABS CONSTRUCTION
Durable and strong, ABS outer shell paired with an EPS liner.



JRAS FIT SYSTEM
JRAS Fit System can be adjusted vertically allowing you to keep your helmet secure whilst skiing.



WRAS 2 FIT SYSTEM
The WRAS Fit System offers full adjustability to ensure a customized and comfortable fit for your head shape. Adjust the height of the rear ergonomic cradle and dial in the perfect pressure using the micro adjustment dial. WRAS is forseen of a big comolded wheel that makes it easy to grab and adjust with gloves. WRAS ensures your helmet fits securely and comfortably.



HALO FIT SYSTEM
Our ultra-light HALO Fit System provides easy adjustability and unparalleled comfort. Find the perfect height of the rear ergonomic cradle while the helmet is on your head and dial in optimal pressure using the micro-adjustment dial. The result is a helmet which adapts to your head shape and leaves you feeling secure and focusing on the line ahead.



D3O®
D3O® is a unique material that focuses on energy dispersion in critical areas for maximum shock absorption and protection. The functionality of the raw material originates from the synergetic effects of the polymer-based dilatant. Energy is distributed throughout the synthetic elastomeric polymer and the enhanced chemistry continues to disperse the energy throughout the matrix, significantly reducing the effect of impact.



CASIDION®
Casidion® is a nanotechnology-based impact material used in our Colouir Mountain. This revolutionary material allows us to significantly reduce the weight & delivers an increased level of protection.



360° PURE SOUND
On the mountain, safety is paramount, and being able to hear what is happening around you can save your life. This is why we have invested in R&D to develop 360° Pure Sound technology, a specifically-shaped inner piece in our ear pads, surrounded by sound transparent fabric. It not only lets you hear better, but also localizes sound more accurately.



AMPLIFIER
The unique aspect of Amplifier is the shape of the visible light transmission curve, optimizing three specific wave lengths: blue, orange and red. These ranges of light are the most important for the human eye to enhance contrast and clarity.



AMPLIFIER LIGHT SENSITIVE
SCOTT Light Sensitive lenses use photochromic technology and get darker or brighter automatically depending on the surrounding light conditions.



OTG
OTG goggles offer protection from the elements and an optimized fit for people requiring prescription glasses, thanks to a specific and adapted construction.



ACTIVE VENTING
This system revolves around one easy-to-use slider that opens or closes multiple venting holes, allowing the user to optimally regulate ventilation in all weather conditions.



PASSIVE VENTING
Built-in system regulating the airflow through the helmet.



DUAL ACTIVE VENTING SYSTEM
Our most advanced venting system allows the user to carefully regulate the airflow through the helmet for optimal ventilation in any weather condition. This is achieved through two easy-to-use sliders that allow the ventilation to be fine-tuned at the front and top of the helmet.



MAGNETIC VISOR MECHANISM
The Blend Plus is featured with a clever Magnetic Visor Mechanism, the visor can be securely positioned in lower and upper position through the use of magnets to offer maximum freedom of use.



VISOR CHANGE MECHANISM
The visor is attached on the helmet by two ropes with a lock. The ropes are here to guide the visor to lower and upper positions. It also prevents the visor from falling off of the helmet. The visor can be changed easily as you would change goggles by unclipping the locks from the shell.



VISOR FIT PADDING
To have a perfect fit between visor and nose, we implemented a modular padding into our Blend Plus helmet. For a personal fit, take out the grey patch you find in the liner and try the helmet with visor on with and without, choose what suits you best!

GOGGLES & EYEWEAR



ACS
ACS ventilation incorporates lens air intake vents on the goggle lens and frame air outtake vents on the bottom of the goggle.



IMPACT PROTECTION
In order to ensure that riders are safe from the impact of pebbles and flying debris, all SCOTT lenses not only meet, but exceed the required impact resistance standards required for MX lenses.



SPACER FOAM AND DOUBLE LENSES
Spacer Foam and Double Lenses block moisture and eliminate fogging, while allowing for optimal breathability.



FACE FOAM1
Soft, single-density face foam delivers a precise fit around facial features while sealing out the elements.



FACE FOAM2
This two-layer, open-celled face foam with fleece has excellent moisture-absorbing and thermal properties, ensuring that you stay warm, dry, and comfortable all day.



FACE FOAM3
This three-layer, open-celled face foam with fleece has excellent moisture-absorbing properties, and offers increased levels of comfort and an improved fit thanks to the extra layer of protective foam.



NO SWEAT
This unique face foam consists of a microfiber layer that is extremely water absorbent. It soaks up moisture fast and avoids sweat getting into your eyes or inside the goggle.



NO FOG
SCOTT lenses undergo a permanent NoFog™ treatment process to prevent condensation and fogging.



STANDARD VENTILATION
Frame ventilation is optimized around the entire frame in order to channel airflow onto the lens, as opposed to the eyes. This technology blocks snow and water from entering the goggle.



OTG
OTG goggles offer protection from the elements and an optimized fit for people requiring prescription glasses, thanks to a specific and adapted construction.



RAM AIR 2
RAM Air 2.0 is the evolution of our integrated Revolutionary Air Management system. Unique air vents located on each extremity of the goggle frame channel the air towards the inside of the lens, reducing the chance of fogging.



LCG SYSTEM
SCOTT's patent-pending Lens Change System offers quick and effortless lens interchangeability. The mechanical slider on the side of the goggle raises the lens off the frame, meaning the lens can easily be changed without having to touch the surface of the lens or take off your gloves.



SILICONE STRAP
Adhered silicone strips on the inside of the goggle strap ensures the goggles stay in place on your helmet.



EXTRA WIDE 50 MM NO SLIP SILICONE STRAP



VENTFOAM-MEMBRAN
The SCOTT Vent Foam membrane is an open cell layer that is breathable enough to offer supreme ventilation and strong enough to protect from wind, dirt, and dust - just the right balance.



FIT SYSTEM
SCOTT's Goggle Fit System is a mechanical adjustment that creates a custom face and nose fit. Two pivot points located at the bottom of each side of the goggle can be adjusted in several positions allowing the goggle to fit tightly against the rider's face.



OPTIMIZED HELMET-INTEGRATION
SCOTT goggles are engineered to be perfectly compatible with a variety of helmets, including SCOTT's entire helmet line.



HARD COATING
SCOTT hard coating creates a permanent bond with the lens that reduces the appearance of hairline scratches and provides overall lens durability.



ADJUSTABLE NOSEPADS
The adjustable nose piece allows for truly conforming, individual fit. Just as no two people are alike, neither are their noses. This custom-fit piece offers superior grip and unparalleled comfort.



UV PROTECT
All SCOTT lenses are optically engineered to screen out 100% of harmful UVA/UVB rays.



ELC LENS CHANGE SYSTEM
Delivered with an extra lens, it's easier than ever to adapt your vision. Introducing our new ELC system - it will take you just a few seconds to switch lenses and continue your ride with the lens best adapted to the light. Better vision, better comfort, better performance.



HINGE FLEX
The innovative hinge flex construction paired with the textured temple tips minimizes pressure points while providing supreme grip.



LOW PRESSURE TEMPLE
The innovative temple tip rubber construction minimizes pressure points while providing supreme grip - all you need to focus on is the ride ahead of you.



MAXIMUMFIELD-OF VISION
A comfortable and precise frame fit is necessary to maintain concentration, and to ensure an optimal field of vision. The frame is designed specifically to rest as closely as possible to your face compared with conventional eyewear and ensures a wider field of vision, without the blinders effect.



MAGNETIC LENS
Minimal product design with seamless integration of lens change mechanism. The magnetic slider lifts the lens off the goggle to offer a the ease of a 1-hand useability. The magnets engage an optimized handling of the lens change.



BIO BASED
All of our sunglasses' frames are made from 45% bio-based polymers sourced from castor beans, contributing to the reduction of our carbon footprint and dependency on fossil fuels, while maintaining a high level of performance.



POLARIZED
Polarized lenses filter the light to reduce glare and eyestrain. They block bright reflections from different surfaces, like snow, water, or road surfaces. When glare is reduced you can see your surroundings clearer.



SPHERICAL LENS
Spherical lenses are manufactured to mimic the shape of the human eye in order to provide superior vision in all directions. A greater chamber volume also helps to prevent fogging.



CYLINDRICAL LENS
Cylindrical lenses curve from left to right, are flat from top to bottom and are low profile and flexible.



AUTOMATIC LENS LOCK SYSTEM
The new Lens Lock Automatic securely locks the lens in the goggle - zero risk to lose the lens. Seamless sealing. Well thought positioning of the magnets keep the slider intentionally locked.



FULLY INTEGRATED LENS CHANGE MECHANISM
Minimal product design with seamless integration of lens change mechanism. The magnetic slider lifts the lens off the goggle to offer a the ease of a 1-hand useability. The magnets engage an optimized handling of the lens change.



AMPLIFIER
The unique aspect of Amplifier is the shape of the visible light transmission curve, optimizing three specific wave lengths: blue, orange and red. These ranges of light are the most important for the human eye to enhance contrast and clarity.



AMPLIFIER PRO
The new patent-pending SCOTT AMP Pro lens technology offers you the best contrast ever developed and brings out every detail, even in low light conditions. Thanks to its characteristic natural tint, colours remain true to nature, reducing eye strain and improving visual comfort.



AMPLIFIER LIGHT SENSITIVE
SCOTT Light Sensitive lenses use photochromic technology and get darker or brighter automatically depending on the surrounding light conditions.

PROTECTION



BACKPACK-FRIENDLY
Some of our plates are so thin that you can even wear a backpack over them.



EASILY WASHABLE
The protective plate is easily removable from the pocket.



EXTLUMBAR-PADDING
For improved protection of your back and spine, with extended support in the crucial lumbar area.



SOFTSHELL
Soft-shell construction offers the best flexibility, breathability and comfort.



D3O®
D3O® is a unique material that focuses on energy dispersion in critical areas for maximum shock absorption and protection. The functionality of the raw material originates from the synergetic effects of the polymer-based dilatant. Energy is distributed throughout the synthetic elastomeric polymer and the enhanced chemistry continues to disperse the energy throughout the matrix, significantly reducing the effect of impact.



AIRFLEX
The EN 1621-2 test drops a 5kg weight on our protector from a 1m height. By measuring the residual force, we design a protector to be Level 1 or Level 2.

Level 2 protection offers twice the protection of Level 1.



HARD-SHELL
Hard-shell construction delivers great protection against penetration and impact.



REMOVABLE ADJUSTMENT BELT
The removable adjustment belt ensures a seamless fit and prevents any gap between you and your back protection.



WOMEN-SPECIFIC DESIGN
Since women's body shapes are different to men's, we offer women-specific features like a thinner belt, pre-shaped shoulder straps and specific sizing.



SHOCK ABSORPTION
D3O® technology focuses on energy absorption and protection.



VENTILATION
SCOTT exclusive design with strategically placed air vents to control body temperature by allowing maximum airflow. With an exclusive SCOTT design, the vents have been strategically placed to allow maximum airflow and control body temperature.



COMFORT THROUGH FLEXIBILITY
Light and flexible, the Airflex plate adapts perfectly to the shape of your body to give you maximum freedom of movement.



CE CERTIFIED
Integrated D3O® protectors ensure the highest levels of safety according to the CE EN1621 standard.

BACKPACKS & BAGS



ALPRIDE-E2
Fully electronic avalanche airbag system with supercapacitor technology, LCD display and automatic pressure relief valve.



ALPRIDE E1
Fully electronic avalanche airbag system with supercapacitor technology.



ALPRIDE 2.0
Alpride 2.0 is a purely mechanical system, and thanks to its small gas cartridges, it is one of the lightest and most compact airbags on the market.



EMERGENCY ASSISTANCE
Safety print with an emergency signals guide to assist in case of emergency. There are signals for whistle alert and replies, recovery position, helicopter signing and emergency phone numbers. And / or equipped with an emergency whistle.



AVALANCHE EQUIPMENT
Dedicated avalanche rescue tool compartment to guarantee fast and easy access.



GOGGLE POCKET
Dedicated pocket which fits a goggle.



DIAGONAL CARRY
Diagonal ski fixation system ideal for short steep climbs. The top and bottom loop are connected and use only one fixation point. Open the buckle on the top, pull out the bottom loop, hook in the skis, tighten the bottom loop by pulling the upper webbing loop, close the buckle over the skis and tighten the webbing to secure the skis.



FRAME CARRY
One ski is attached on each side of the backpack for an even weight distribution and better balance. Use a strap on the ski tops to keep the skis together for even better stability.



SNOWBOARD CARRY
Carry system for snowboard & snow shoes.



COMPRESSION
Compression straps which brings the load and weight closer to the back of the pack.



WINTER HELMET CARRY SYSTEM
Net fixation for a winter helmet.



ICE PICK FIXATION
Fixation for ice axes or poles.



EQUIPMENT FIXATION LOOPS
Mounting loops made of durable webbing are versatile and ideal for mounting additional equipment that is easily accessible.



DYNEEMA®
Dyneema® fabrics make products lighter and more comfortable without compromising on strength and durability. Available as composites, denim, knits and wovens, these fabrics are the game-changers for the outdoor, sport and fashion industry.



CORDURA®
CORDURA® fabrics offer enhanced tear and abrasion resistance with a wide variety of apparel styling options. Fabrics look and feel like cotton with durable, long-lasting nylon performance. There is an exceptional strength-to-weight ratio.

SKIS



WHAT YOU NEED TO KNOW

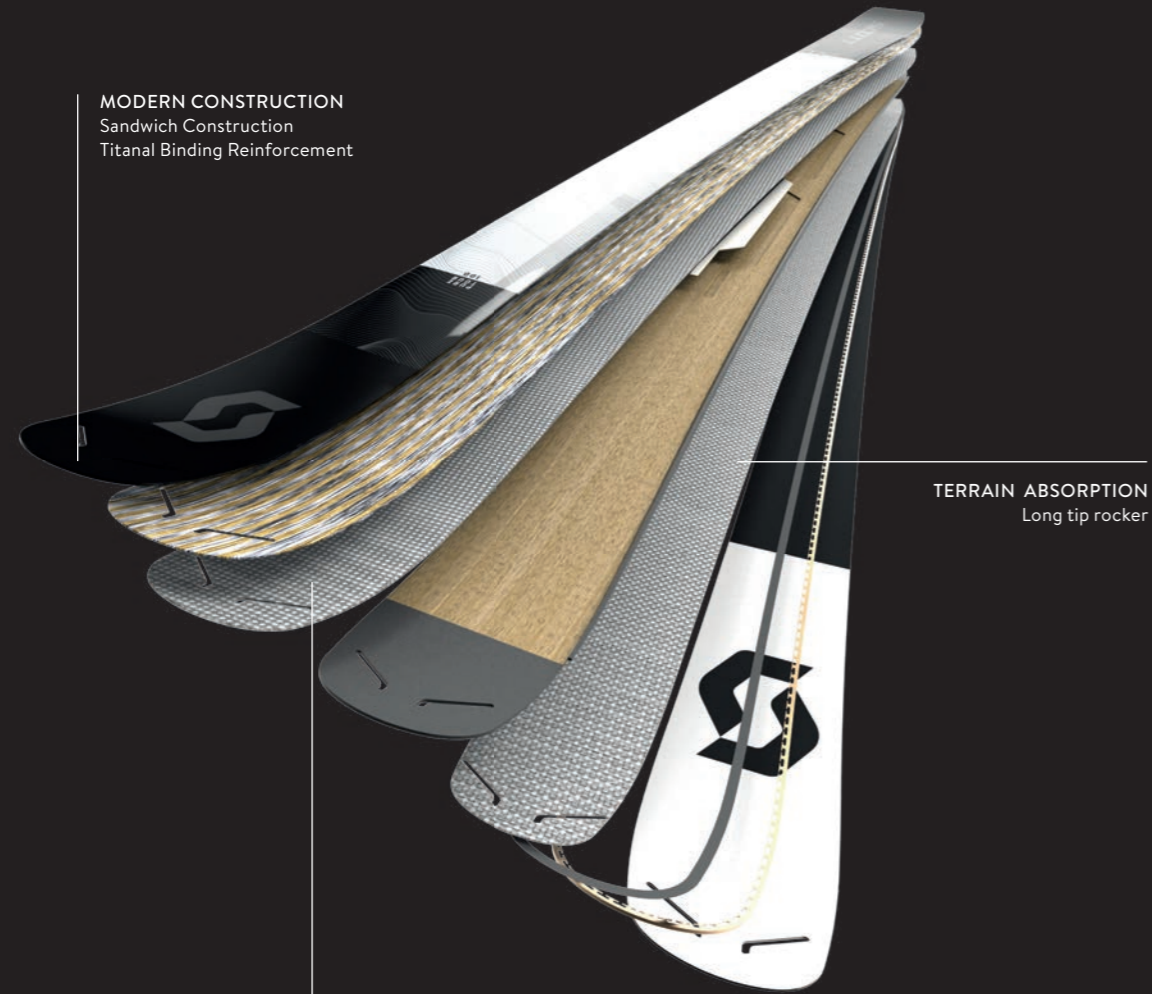

MODERN CONSTRUCTION
Sandwich Construction
Titanal Binding Reinforcement

TERRAIN ABSORPTION
Long tip rocker

PARTLY MADE BY SUSTAINABLE MATERIALS
Natural Flax fibre

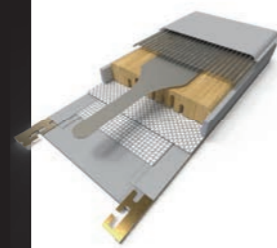

RESPONSIVE AND LIGHT CORE

Certified poplar wood core production and air channel.

PURE TOUR



SCOTT PURE TOUR 100 SKI

411087

The all-new SCOTT Pure Tour 100 is your One Ski Quiver: playful enough to be used every day, light enough for touring, and shaped for freeride. You've got it all-in-one! With its shorter radius, longer rocker and new tip shape, it's got the secret recipe for versatility. Introducing a new generation of skis, it has a brand new sustainable construction, using flax fiber for smooth flex, and poplar for the pop, meaning you can respect the mountains while also shredding it on a daily basis.

ROCKER TYPE: Freeride Tip and Tail Rocker M

ECO FEATURES:

CONSTRUCTION: Sandwich Tour Eco

- 100% certified poplar wood core
- Natural flax fiber reinforcements
- Partly recycled base
- Partly recycled edges
- Partly biobased topsheet
- Partly recycled Titanal reinforcements
- More than 40% eco-content by weight

FEATURES:

- Poplar Wood Core
- SCOTT Hook Skin Fixation System
- Titanal Reinforcement
- Full length Sidewall
- Air Tec

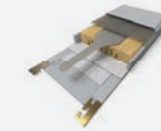

LENGTH (cm)	TIP (mm)	WAIST (mm)	TAIL (mm)	RADIUS (m)	SURFACE (m ²)	APPROX. WEIGHT (g) (per ski, pair, size)
170	126	96	116	16	0.34	1410
178	131	98	120	17	0.37	1480
186	133	100	122	18	0.4	1550

BORN AND NURTURED IN THE ALPS

The Pure Pro 109Ti is equipped with a progressive titanal layer that harmonizes the flex and add power transmission when coming out of a turn. At the same time, the ski delivers more stability, enabling you to hold your line while riding steep big-mountain lines. The Pure Pro 109Ti impresses with its light weight and performance, thanks to the dual-power wood core – a mix of paulownia and 2 beech stringers that cover the full length of the ski. The combination of paulownia and beech gives an extra when it comes to torsional stiffness. So you can go all in on those high-speed runs.

PURE

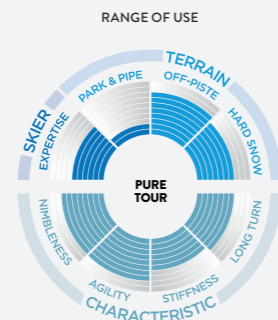

SCOTT PURE TOUR 90 WOMEN'S SKI 411088

The all-new SCOTT Pure Tour 90 W's is your One Ski Quiver: playful enough to be used every day, light enough for touring, and shaped for freeride. You've got it all-in-one! With its shorter radius, longer rocker and new tip shape, it's got the secret recipe for versatility. Introducing a new generation of skis, it has a brand new sustainable construction, using flax fiber for smooth flex, and poplar for the pop, meaning you can respect the mountains while also shredding it on a daily basis.

ROCKER TYPE: Freeride Tip and Tail Rocker M
CONSTRUCTION: Sandwich Tour Eco

- FEATURES:**
- Poplar Wood Core
 - SCOTT Hook Skin Fixation System
 - Titanal Reinforcement
 - Full length Sidewall
 - Air Tec

- ECO FEATURES:**
- 100% certified poplar wood core
 - Natural flax fiber reinforcements
 - 50% recycled base
 - 20% recycled edges
 - 50% biobased topsheet
 - Partly recycled Titanal reinforcements
 - More than 40% eco-content by weight

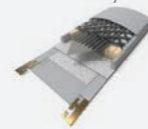

LENGTH (cm)	TIP (mm)	WAIST (mm)	TAIL (mm)	RADIUS (m)	SURFACE (m ²)	APPROX. WEIGHT (g) (per ski, pair, size)
152	120	90	108	14	0.28	1270
160	122	93	112	15	0.31	1340
168	126	96	116	16	0.34	1410



- JÉRÉMIE HEITZ -



FREERIDE

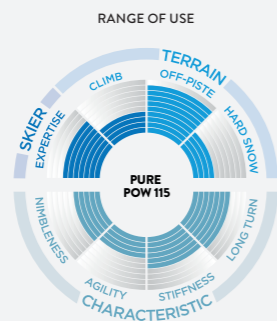

SCOTT PURE POW 115TI SKI

291923

The new SCOTT PURE Pow 115Ti is made for POW days on open mountains as well as on playful forests. Utilizing SCOTT's carbon/light wood core sandwich construction, the PURE Pow 115Ti combines all the ingredients of a winner – powerful and ultra-stable everywhere, yet light and nimble when needed.

ROCKER TYPE: Freeride Tip and Tail Rocker L

FEATURES:

- Paulownia Poplar Wood Core
- Carbon Aramid Fibers
- Titanal Reinforcement
- SCOTT Hook Skin Fixation System

CONSTRUCTION: Sandwich Powder

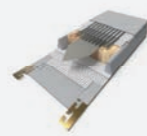

LENGTH (cm)	TIP (mm)	WAIST (mm)	TAIL (mm)	RADIUS (m)	SURFACE (m ²)	APPROX. WEIGHT (g) (per ski, pair, size)
182	142	115	131	23	0.43	1800
189	144	116	133	24	0.46	1900

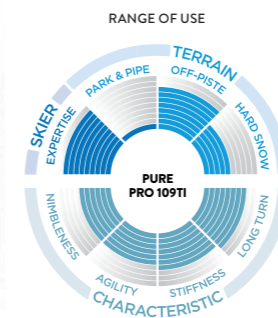

SCOTT PURE PRO 109TI SKI

410726

Made by and for Jérémie Heitz, the SCOTT Pure 109 is a true freeride weapon. A progressive Titanal layer allows for a more direct and responsive performance, while a wood core ensures a smooth ride and makes every turn easy to navigate, no matter whether you're hurtling down a north face or floating through fresh powder. Thanks to their new construction, these skis are light enough to take you out exploring any wild face, yet powerful when it comes to enjoying the descent.

ROCKER TYPE: Freeride Tip and Tail Rocker L

FEATURES:

- Dual Power Wood Core (Paulownia/Beech)
- Carbon Fibers
- Titanal Reinforcement
- Pure Freeride Sidecut
- SCOTT Hook Skin Fixation System

CONSTRUCTION: Sandwich Freeride

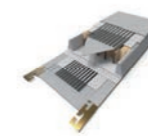

LENGTH (cm)	TIP (mm)	WAIST (mm)	TAIL (mm)	RADIUS (m)	SURFACE (m ²)	APPROX. WEIGHT (g) (per ski, pair, size)
172	142	109	128	19	0.41	1700
182	142	109	128	21	0.43	1850
190	142	109	128	23	0.45	2000

SCOTT PURE MISSION 98TI SKI

291925

Inspired by Jérémie Heitz freeride skis, the all-new SCOTT Pure Mission 98 Ti is a freeride-all mountain weapon. Whatever the snow and the conditions, the new Pure Mission 98 Ti will allow you to enjoy the mountain every day of the season. The titanal and sandwich construction deliver the stability and performance needed when the light wood and carbon fibers make the ski manoeuvrable. For those who enjoy as much resort skiing as backcountry, the SCOTT mission is BACK.

ROCKER TYPE: Freeride Tip and Tail Rocker M

FEATURES:

- Dual Power Wood Core (Paulownia/Beech)
- Carbon Fibers
- Titanal Reinforcement
- Pure Freeride Sidecut
- SCOTT Hook Skin Fixation System

CONSTRUCTION: Sandwich Freeride

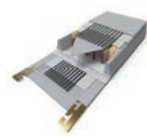

LENGTH (cm)	TIP (mm)	WAIST (mm)	TAIL (mm)	RADIUS (m)	SURFACE (m ²)	APPROX. WEIGHT (g) (per ski, pair, size)
170	133	98	119	17	0.38	1500
177	133	98	119	19	0.40	1670
184	134	99	121	21	0.42	1830

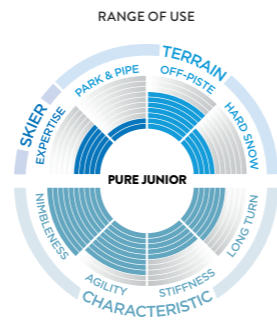
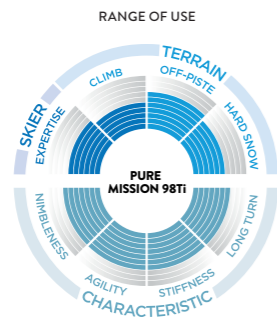

SCOTT PURE MISSION 98TI W'S SKI 291927

The SCOTT Pure Mission 98 Ti W's is a women freeride all mountain weapon. Whatever the snow and the conditions, the new Pure Mission 98 Ti Women will allow you to enjoy the mountain every day of the season. The titanal and sandwich construction deliver the stability and performance needed when the light wood and carbon fibers make the ski manoeuvrable. For who enjoy as much resort skiing as backcountry, the SCOTT Mission is BACK and now for women too.

ROCKER TYPE: Freeride Tip and Tail Rocker M
CONSTRUCTION: Sandwich Freeride

- FEATURES:**
- Dual Power Wood Core (Paulownia/Beech)
 - Carbon Fibers
 - Titanal Reinforcement
 - Pure Freeride Sidecut
 - SCOTT Hook Skin Fixation System

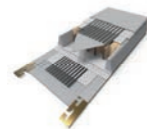

SCOTT PURE JR SKI 291934

Made for the next Jérémie Heitz, the SCOTT Pure Junior is the ultimate freeride weapon for the next generation, featuring a full wood core for a smooth ride.

ROCKER TYPE: Freeride Tip and Tail Rocker S
CONSTRUCTION: Sandwich

- FEATURES:**
- Poplar Wood Core
 - Fiberglass

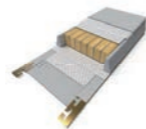

LENGTH (cm)	TIP (mm)	WAIST (mm)	TAIL (mm)	RADIUS (m)	SURFACE (m ²)	APPROX. WEIGHT (g) (per ski, pair, size)
160	132	98	118	16	0.36	1350
168	133	98	119	17	0.38	1500
175	133	98	119	19	0.40	1670



LENGTH (cm)	TIP (mm)	WAIST (mm)	TAIL (mm)	RADIUS (m)	SURFACE (m ²)	APPROX. WEIGHT (g) (per ski, pair, size)
142	124	86	112	10	0.32	1340
152	126	88	114	12	0.33	1420
162	128	90	116	13	0.35	1520
172	130	92	118	15	0.34	1690



ALL MOUNTAIN

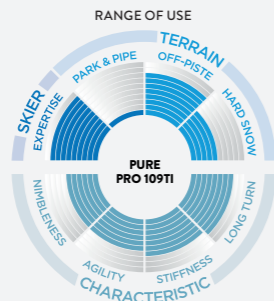

SCOTT PURE AM 92TI SKI

414483

Coming this season, the new Pure All-Mountain 92 TI features a construction, made of a wood core with double reinforcement. In the middle of the ski, Titanal has been added for more power and dampening. For torsional stiffness, it features a layer of carbon fibre that crosses at 45 degrees along the length of the ski. The result is a ski that behaves very well both within the limits and in softer snow. The pleasure remains the same! And, thanks to its light weight, you will also be happy to mount a touring binding and stick a skin from the grooves on the tip.

ROCKER TYPE: All Mountain Tip and Tail Rocker M

CONSTRUCTION: Sandwich All Mountain

FEATURES:

- Paulownia Poplar Wood Core
- Carbon 45° Fibers
- Titanal Reinforcement
- Full length Sidewall
- Pure Freeride Sidecut

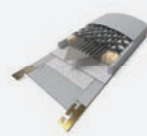

LENGTH (cm)	TIP (mm)	WAIST (mm)	TAIL (mm)	RADIUS (m)	SURFACE (m ²)	APPROX. WEIGHT (g) (per ski, pair, size)
165	132	88	120	13	0.34	1470
170	134	90	122	14	0.35	1500
175	136	92	124	15	0.36	1540
180	138	94	126	16	0.37	1600
185	140	96	128	17	0.38	1700

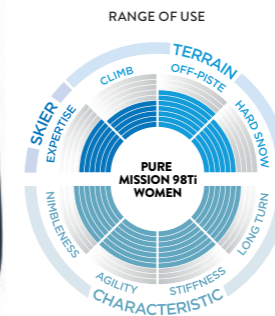

SCOTT PURE AM 92TI WOMEN'S SKI

414484

Coming this season, the new Pure All-Mountain 92 TI W's features a construction, made of a wood core with double reinforcement. In the middle of the ski, Titanal has been added for more power and dampening. For torsional stiffness, it features a layer of carbon fibre that crosses at 45 degrees along the length of the ski. The result is a ski that behaves very well both within the limits and in softer snow. The pleasure remains the same! And, thanks to its light weight, you will also be happy to mount a touring binding and stick a skin from the grooves on the tip.

ROCKER TYPE: All Mountain Tip and Tail Rocker M

CONSTRUCTION: Sandwich All Mountain

FEATURES:

- Paulownia Poplar Wood Core
- Carbon 45° Fibers
- Titanal Reinforcement
- Full length Sidewall
- Pure Freeride Sidecut

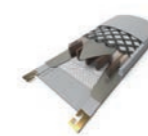

LENGTH (cm)	TIP (mm)	WAIST (mm)	TAIL (mm)	RADIUS (m)	SURFACE (m ²)	APPROX. WEIGHT (g) (per ski, pair, size)
155	128	84	116	11	0.32	1330
160	130	86	118	12	0.33	1400
165	132	88	120	13	0.34	1470

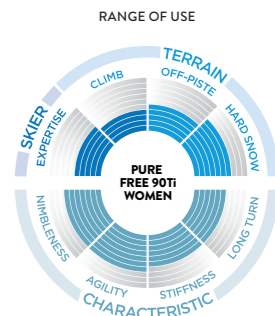

SCOTT PURE FREE 90TI SKI

291929

How to make the inaccessible accessible? The new SCOTT PURE Free 90 Ti has been developed around the idea of making on-piste skiing as well as skiing on fresh powder more accessible and fun. The poplar fiberglass sandwich construction is reinforced with a Titanal layer to achieve total grip, stability, and performance in any condition. The shape with a short radius makes the ski versatile and easy to use. Discover the PURE spirit with an everyday resort ski.

ROCKER TYPE: All Mountain Tip and Tail Rocker L

CONSTRUCTION: Sandwich

FEATURES:

- Poplar Wood Core
- Titanal Reinforcement
- Pure Freeride Sidecut
- Fiberglass

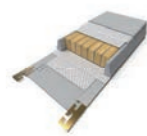

LENGTH (cm)	TIP (mm)	WAIST (mm)	TAIL (mm)	RADIUS (m)	SURFACE (m ²)	APPROX. WEIGHT (g) (per ski, pair, size)
170	126	90	110	17	0.33	1720
177	126	90	111	19	0.34	1860
184	127	90	112	21	0.35	2020

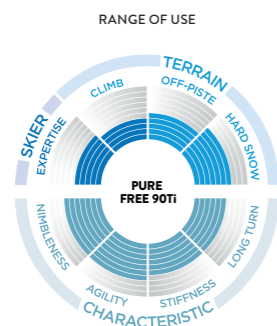

SCOTT PURE FREE 90TI W'S SKI 291931

The new SCOTT PURE Free 90 Ti W's has been developed around the idea of making on-piste skiing as well as skiing on fresh powder more accessible and fun for women. The poplar fiberglass sandwich construction is reinforced with a Titanal layer to achieve total grip, stability, and performance in any condition. The shape with a short radius makes the ski versatile and easy to use. Discover the PURE spirit with an everyday resort ski.

ROCKER TYPE: All Mountain Tip and Tail Rocker L

CONSTRUCTION: Sandwich

FEATURES:

- Poplar Wood Core
- Titanal Reinforcement
- Pure Freeride Sidecut
- Fiberglass

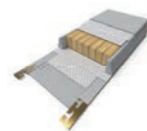

LENGTH (cm)	TIP (mm)	WAIST (mm)	TAIL (mm)	RADIUS (m)	SURFACE (m ²)	APPROX. WEIGHT (g) (per ski, pair, size)
154	125	90	109	15	0.31	1440
160	125	90	109	16	0.32	1580
168	126	90	110	17	0.33	1720





TOURING

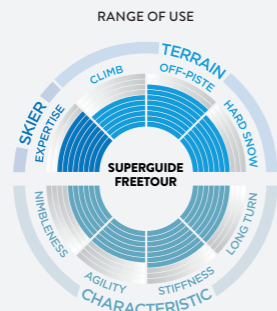

SCOTT SUPERGUIDE FREETOUR SKI 291936

The Superguide Freetour is the holy grail of backcountry skiing: a ski that's light and agile on the way up, with no compromises on those hard-earned lines on the way down. The new Paulownia/Beech core is lightweight yet stable. Combined with Carbon/Aramid fibers, to stiffen the ski without adding weight, the Superguide Freetour boasts a hard-charging construction with a precise 3Dimension Touring Sidecut, that's ready for those fast lines and steep descents.

ROCKER TYPE: Touring Tip Rocker M
CONSTRUCTION: Sandwich Tour

- FEATURES:**
- Dual light wood core (Paulownia/Beech)
 - Carbon stringers Fibers
 - Full length Sidewall
 - 3Dimension Sidecut
 - SCOTT Hook Skin Fixation System



LENGTH (cm)	TIP (mm)	WAIST (mm)	TAIL (mm)	RADIUS (m)	SURFACE (m ²)	APPROX. WEIGHT (g) (per ski, pair, size)
169	132	104	120	22	0.38	1500
178	134	104	122	24	0.40	1580
185	136	105	124	24	0.43	1610

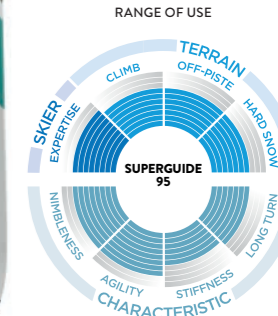
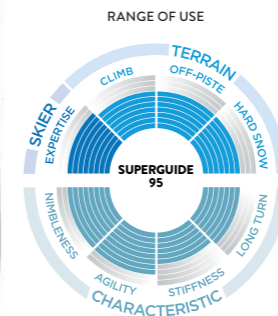
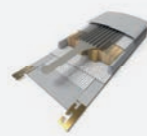

SCOTT SUPERGUIDE 95 SKI 291938

The Superguide is iconic, and this updated model keeps all the freeride DNA of the original, with added touring performance. An all-new lightweight yet playful Paulownia/Beech core with Carbon reinforcement keeps the ski light and agile yet even more hard-charging. Adding an updated 3Dimension Touring Sidecut ensures the ski is stable on the ascent and ready to let loose on the way down – whether that's turning on a dime when things get technical, or opening it up on those long, fast descents.

ROCKER TYPE: Touring Tip Rocker M
CONSTRUCTION: Sandwich Tour

- FEATURES:**
- Dual Wood Core (Paulownia/Poplar)
 - Carbon stringers Fibers
 - Full length Sidewall
 - 3Dimension Sidecut
 - SCOTT Hook Skin Fixation System



LENGTH (cm)	TIP (mm)	WAIST (mm)	TAIL (mm)	RADIUS (m)	SURFACE (m ²)	APPROX. WEIGHT (g) (per ski, pair, size)
162	130	93	111	19	0.34	1310
170	128	94	113	20	0.36	1370
178	132	95	115	21	0.39	1440
184	126	96	117	22	0.42	1500

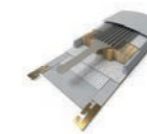

SCOTT SUPERGUIDE 95 W'S SKI 291940

The Superguide is iconic, and this updated model keeps all the freeride DNA of the original, with added touring performance. An all-new lightweight yet playful Paulownia/Beech core with Carbon reinforcement keeps the ski light and agile yet even more hard-charging. Adding an updated 3Dimension Touring Sidecut ensures the ski is stable on the ascent and ready to let loose on the way down – whether that's turning on a dime when things get technical, or opening it up on those long, fast descents.

ROCKER TYPE: Touring Tip Rocker M
CONSTRUCTION: Sandwich Tour

- FEATURES:**
- Dual Wood Core (Paulownia/Poplar)
 - Carbon stringers Fibers
 - Full length Sidewall
 - 3Dimension Sidecut
 - SCOTT Hook Skin Fixation System



LENGTH (cm)	TIP (mm)	WAIST (mm)	TAIL (mm)	RADIUS (m)	SURFACE (m ²)	APPROX. WEIGHT (g) (per ski, pair, size)
160	126	93	111	19	0.34	1310
168	128	94	113	20	0.36	1370



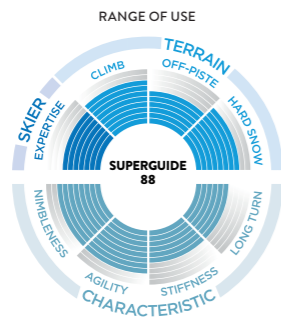

SCOTT SUPERGUIDE 88 SKI

291942

The Superguide 88 has it all: a ski that's as light as possible on the way up, that comes into its own on the way down. The unique construction combines an ultralight Paulownia core with hardwood Beech stringers for a stable yet lively ride. Add in Carbon fibres and a precise 3Dimension Touring Sidecut, and the result is a lightweight package that's surprisingly quick and reliable on the way up and won't let you down on that hard-earned descent.

ROCKER TYPE: Touring Tip Rocker M
CONSTRUCTION: Sandwich Tour

- FEATURES:**
- Dual Wood Core (Paulownia/Poplar)
 - Carbon stringers Fibers
 - Full length Sidewall
 - 3Dimension Sidecut
 - SCOTT Hook Skin Fixation System



LENGTH (cm)	TIP (mm)	WAIST (mm)	TAIL (mm)	RADIUS (m)	SURFACE (m ²)	APPROX. WEIGHT (g) (per ski, pair, size)
162	121	84	106	16	0.32	1200
168	123	86	108	17	0.34	1270
173	124	87	109	17	0.35	1300
178	125	88	110	18	0.36	1340
184	127	90	112	19	0.38	1400

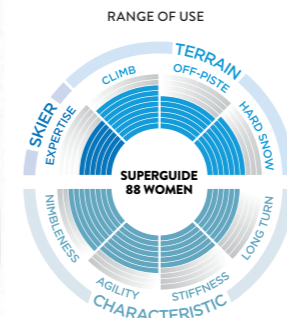
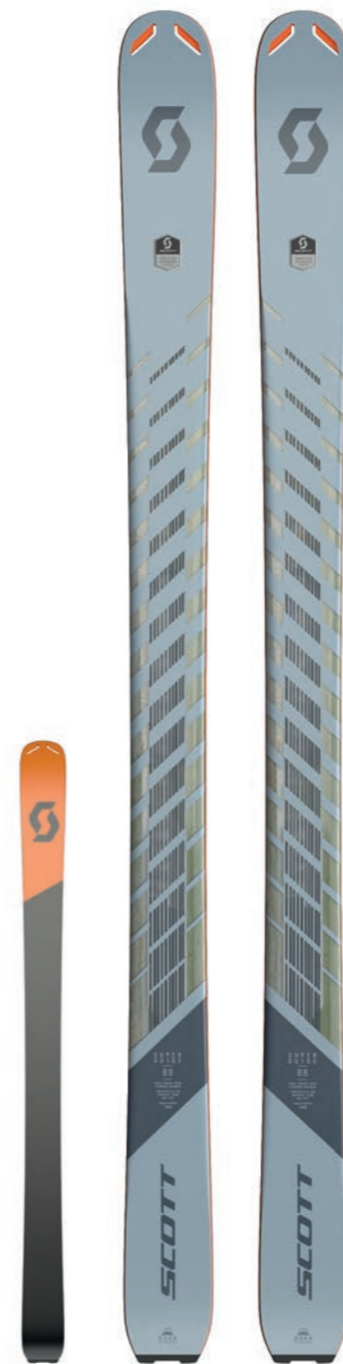

SCOTT SUPERGUIDE 88 W'S SKI

291946

The Superguide 88 has it all: a ski that's as light as possible on the way up, that comes into its own on the way down. The unique construction combines an ultralight Paulownia core with hardwood Beech stringers for a stable yet lively ride. Add in Carbon fibres and a precise 3Dimension Touring Sidecut, and the result is a lightweight package that's surprisingly quick and reliable on the way up and won't let you down on that hard-earned descent.

ROCKER TYPE: Touring Tip Rocker M
CONSTRUCTION: Sandwich Tour

- FEATURES:**
- Dual Wood Core (Paulownia/Poplar)
 - Carbon stringers Fibers
 - Full length Sidewall
 - 3Dimension Sidecut
 - SCOTT Hook Skin Fixation System



LENGTH (cm)	TIP (mm)	WAIST (mm)	TAIL (mm)	RADIUS (m)	SURFACE (m ²)	APPROX. WEIGHT (g) (per ski, pair, size)
144	119	80	104	14	0.30	1100
152	120	82	105	15	0.31	1150
160	121	84	106	16	0.32	1200
168	123	86	108	17	0.34	1270

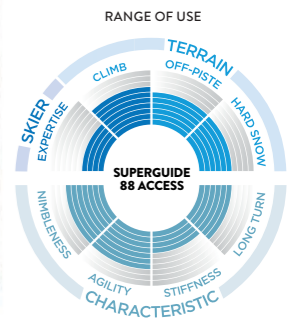

SCOTT SUPERGUIDE 88 ACCESS SKI

291948

The SCOTT Superguide 88 Access is a touring ski designed for discovering the mountain with skins. It features a laminate elliptic sandwich sidewall construction, durable topsheet, thicker base and super strong steel edge to ensure it holds up through the season of ski touring exploration.

ROCKER TYPE: Touring Tip Rocker M
CONSTRUCTION: Sandwich Lite

- FEATURES:**
- Paulownia Wood Core
 - Full length Sidewall
 - 3Dimension Touring Sidecut
 - Fiberglass



LENGTH (cm)	TIP (mm)	WAIST (mm)	TAIL (mm)	RADIUS (m)	SURFACE (m ²)	APPROX. WEIGHT (g) (per ski, pair, size)
144	119	80	104	14	0.30	1270
154	120	82	105	15	0.31	1330
160	121	84	107	16	0.32	1400
168	123	86	108	17	0.34	1470
173	124	87	109	17	0.35	1500
178	125	88	110	18	0.36	1550

SCOTT SKI TECHNOLOGY

SCOTT builds skis the modern way, because skiers use the terrain as their playground, sliding, cutting and carving turns all over the mountain. There are no rules when it comes to skiing style, and there are no shortcuts in developing next-level technology.



THE SCOTT PROGUIDE

PUSHING THE BOUNDARIES OF LIGHTNESS & PERFORMANCE

Lighter for more! Enjoy more elevation, new remote zones and more fresh turns. The new Scott PROGuide skis are built with ultra light materials to be the perfect partner for those who are always hungry for more and want to access the inaccessible.

3DIMENSION SIDECUT – The new 3Dimensional Touring Sidecut is a revolutionary design for a better touring tuning that combines a tip and tail radius with either a central flat line or a small amount of sidecut under foot. The tip and tail radii allow for easy turn initiation while the flat line or a larger radius provides stability, power and precise edge hold. In addition to the new 3Dimension Touring sidecut our established 3Dimension Sidecut increases the skiability and performance in our freeride skis. In addition to the new 3Dimension Touring sidecut our established 3Dimension Sidecut increases the skiability and performance in our freeride skis.

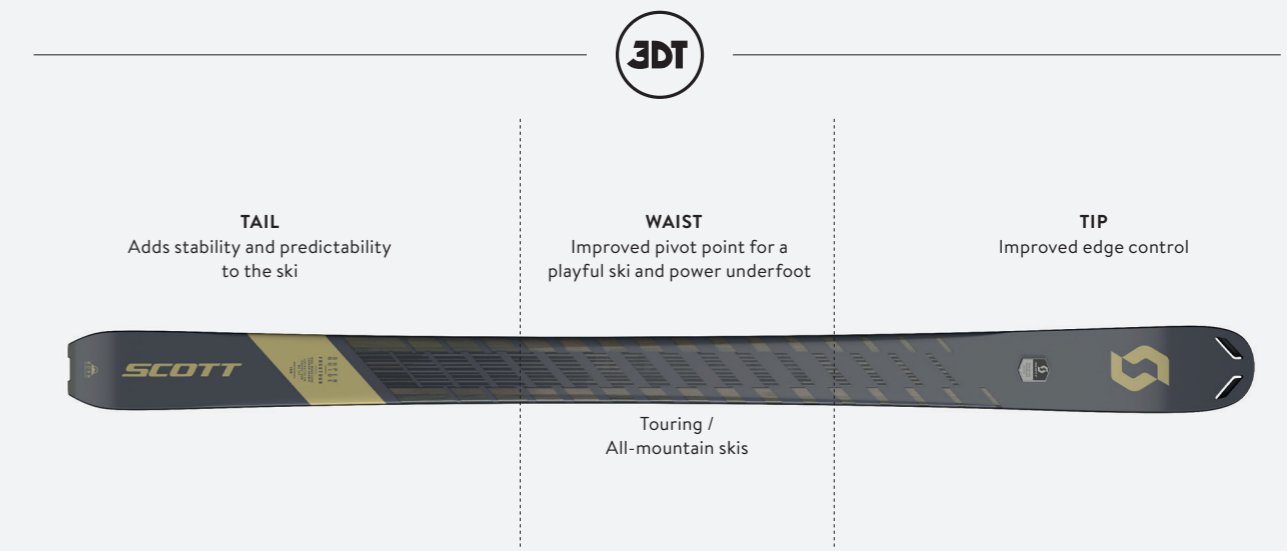

ROCKER TECHNOLOGY

Twin-Tip Rocker

Having rocker in both the tip and tail allows for optimal float in deep snow and creates a playful ski, while traditional camber underfoot maintains edge hold and stability.

- + Maintains performance and versatility
- + Creates a forgiving and playful ski
- + Improves ski flotation in powder

BIG MOUNTAIN
DEEP POWDER
EFFORTLESS FLOAT **(M)**

Pro-Tip Rocker

Combining a progressive shape with increased tip height and radius creates Pro-Tip Rocker. SCOTT's Pro-Tip provides a more versatile and forgiving ski no matter the conditions.

- + Increases stability in powder and deep snow
- + Creates a more forgiving ski, allowing skiers to adjust turn shape
- + Improves ski agility and progressiveness

ALL-TERRAIN
PRECISION

320

ON-PISTE
CARVE SPECIFIC

250

VARIABLE SNOW CONDITIONS
VERSATILITY

350

ON-PISTE
PERFORMANCE

300

SCOTT SKI CONSTRUCTION

CARBON FIBER IN SCOTT WINTERSPORTS

SCOTT uses carbon fiber in the construction process because it's a strong yet lightweight material that never sacrifices performance. Light, stiff and with unrivalled performance, carbon construction is used in SCOTT skis, poles and boots because there are no shortcuts when it comes to building better products.

To achieve the best performance possible, the core construction of a ski is pivotal. That's why the composition of every SCOTT ski is carefully engineered and thoroughly tested in order to provide skiers with the most innovative and weight-efficient skis.

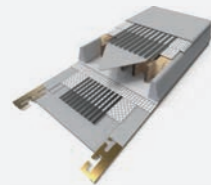

SANDWICH FREERIDE

Sandwich construction dedicated to our high end freeride skis. We use a combination of beech and poplar to create the best wood core to ensure performance and forgiveness. Loaded with carbon stringer for the rebound, the dampness and control are provided by the Titanal inlays under the foot. The lightness was crucial to us during the development, we switch traditional materials for high end, so you get the same performance in a lighter package. It will float better in powder, and you can mount it with free touring binding.

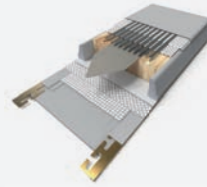

SANDWICH POWDER

Sandwich construction dedicated to our fattest freeride skis. We use a full poplar wood core to ensure performance and lightness. Carbon fibers on top of the wood core and aramid underneath ensure the highest performance. The dampness and control are done by Titanal inlays under the foot, so you can enjoy any conditions. The lightness was crucial to us during the development, we switch traditional materials for high end, so you get the same performance in a lighter package. Rather you're ripping through chopped snow or cruising in a pow field this is the structure you need.

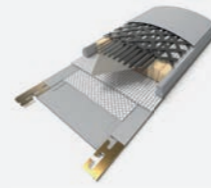

SANDWICH ALL MOUNTAIN

Sandwich construction dedicated to get the best grip while being super lively. We use a poplar wood core milled in an elliptic shape to ensure the best edge to edge performance. This ski is loaded with carbon in two different layers: carbon stringers for the rebound and 45-degree fibers to control the torsion. Titanal inlays under foot ensure the dampness you need to rip down any inbound terrain. By switching traditional materials for high end, you get the same performance in a lighter package, and it will float better in powder.



SANDWICH PISTE

Sandwich construction dedicated to get the best piste performance. We use a poplar wood core milled in an elliptic shape to ensure the best edge to edge performance. This ski is loaded with 45-degree carbon fibers to control the torsion. Titanal inlays under and above the wood core take care of the power transfer while carving down the slopes. As all our constructions we focus on lightweight, so can have fun longer!

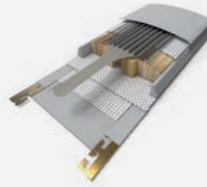

SANDWICH TOUR

Sandwich construction for our touring skis. We use a full-length light Paulownia wood core with Poplar reinforcement. Layers of fiber Titanal underfoot are ensuring the grip and torsional stiffness you need in icy condition. While full length carbon fiber stringers make the ski lively. This is the best construction for downhill performance in our ski touring range. Light to enjoy the uphill. Full of power and grip on the way down. The only benefit you don't get with our top of the range construction is the reward beer at the end of the day.

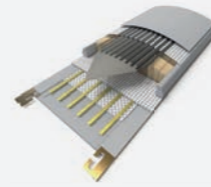

SANDWICH TOUR LITE

Sandwich construction for our lightest touring skis. We use a full-length light Paulownia wood core to be as light as it could be. A layer of aramid underneath and carbon stinger above the wood core ensure the grip and torsional stiffness you need in icy condition, while keeping the ski lively. This is our lightest construction for our ski touring range. Light for the longest ascents, plenty of control and fun on the way down, now your set for your longest missions in the backcountry.

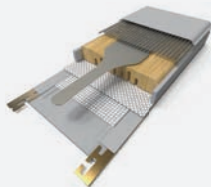

SANDWICH TOUR ECO

Sandwich construction for our Re-source skis, essentially made from recycled materials. We use a full-length light certified poplar wood core milled with air channels (air-tec). Flax fibers reinforcement are used in the usual place of synthetic fibers. On top of being natural and eco-responsible they damp the ski. The eco-sourced Titanal layer under foot ensure the torsional stability you need to enjoy any conditions. Awarded by the ISPO, this is the most sustainable construction in our range.

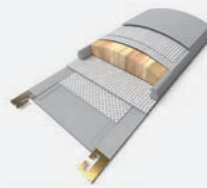

SANDWICH LITE

Sandwich Lite construction for our accessible touring skis. We use a full-length light poplar wood core for lightness. Layers of fiber glass underfoot are ensuring the grip and torsional stiffness you need in icy conditions. While full length fiberglass layer makes the ski lively. We focus on creating a forgiving structure, suitable for any condition and performant when you want to. It's the lightest ski construction, without carbon and you'll enjoy it every day of the season.

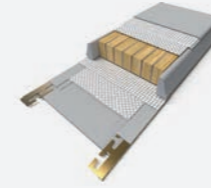

SANDWICH

Sandwich construction for our accessible skis. We use a full-length light poplar wood core for performance and control. Layers of reinforcement underfoot are ensuring the grip and torsional stiffness you need in icy conditions. While full length fiberglass layer makes the ski lively. We focus on creating a fun structure, suitable for any condition and performant when you want to. It's the perfect tool to perform and get better every day.

BOOTS



WHAT YOU NEED TO KNOW



FEATURES

- Integrated rear hook ski/walk mechanism
- Thermo and Memo fit liner foam
- Vibram® bi-density rubber Soles
- Dynafit® certified tech inserts
- Carbon Inlays reinforcement
- Replaceable heel soles
- Rebound Pro Strap

SCOTT SCOPE BOOT



The Scope ski boot is the new crossover ski boot generation with GripWalk® compatibility. The precise fit offers powerful energy transmission for ultimate downhill performance. The walkability of the boots is permitted by an integrated ski/walk mechanism and a 2-part tongue that allows a 60° cuff rotation. The all-new inner liner ensures exceptional comfort, keeping your feet warm and delivering precision.

FLEX INDEX: 120
FORWARD LEAN: 15°
CUFF ROTATION: 60°
CLOSURE: 3 Ergal® micro-adjustable buckles, Velcro Strap
LAST WIDTH: 101 mm
LINER: Scope
SYSTEM: ISO 9523 Touring (UNI), GripWalk® Certification
APPROX. WEIGHT: 1430g (size 26.5)
SIZE: 24-29.5

- FEATURES**
- Integrated rear hook ski/walk mechanism
 - Full-length Skywalk rubber sole
 - Thermo and Memo fit liner foam
 - Vibram® bi-density rubber Soles
 - Dynafit® certified tech inserts
 - Replaceable heel soles
 - Lock catches



black red

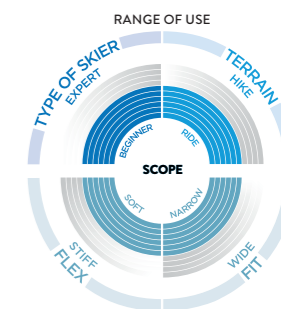

stealth black

FREERIDE
ALL MOUNTAIN
BOOTS

SCOTT SCOPE PRO BOOT

412059



The SCOTT Scope Pro ski boot is our new standard in freetouring ski boots with GripWalk® compatibility. The incredible fit of the carbon fiber shell offers precise and powerful energy transmission for ultimate downhill performance. The walkability of the boot is permitted by an integrated ski/walk mechanism and a 2-part tongue that allows a 60° cuff rotation. The inner liner ensures exceptional comfort, keeping your feet warm and delivering precision. The rebound Pro Strap brings an infinite support and reactivity to the pro models.

FLEX INDEX: 130
FORWARD LEAN: 15°
CUFF ROTATION: 60°
CLOSURE: 3 Ergal® micro-adjustable buckles, Rebound Pro Strap
LAST WIDTH: 101 mm
LINER: Scope Pro
SYSTEM: ISO 9523 Touring (UNI), GripWalk® Certification
APPROX. WEIGHT: 1470g (size 26.5)
SIZE: 24-29.5

- FEATURES**
- Rebound Pro strap
 - Integrated rear hook ski/walk mechanism
 - Full-length Skywalk rubber sole
 - Thermo and Memo fit liner foam
 - Vibram® bi-density rubber Soles
 - Dynafit® certified tech inserts
 - Carbon Inlays reinforcement
 - Lock catches
 - Replaceable heel soles

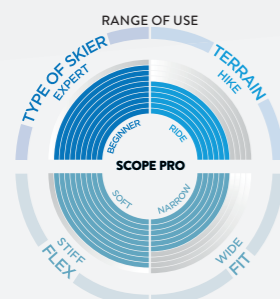

TOURING
BOOTS



stealth black

SCOTT COSMOS PRO BOOT

404862

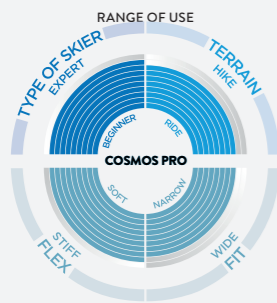

Upgraded version of the SCOTT Cosmos Pro, this boot is made for those who have no limits. Long expedition and downhill performance is where the boot excels. It's made of a Grilamid® mix material and features a flex index of 130 AT. The Cabrio Hybrid construction delivers a 60° range of motion for easy and convenient walkability, while also providing support for downhill skiing. The rebound Pro Strap brings an infinite support and reactivity to the pro models. Buckles and tongue have been improved for easy handling and smooth step-in.

FLEX INDEX: 130
FORWARD LEAN: Adjustable 12° or 14°
CUFF ROTATION: 60°
CLOSURE: 3 Ergal® micro-adjustable buckles, Rebound Pro Strap
LAST WIDTH: 103,5mm
LINER: PWR Lite Pro
SYSTEM: ISO 9523 Touring (UNI)
APPROX. WEIGHT: 1380g (size 26.5)
SIZE: 23-31.5

- FEATURES**
- Rebound Pro Strap
 - Adjustable forward lean
 - Dynafit® certified tech inserts
 - Lock catches
 - Rear Hook Ski/Walk Mechanism
 - Thermo and Memo fit liner foam
 - Vibram® bi-density rubber Soles

SCOTT COSMOS TOUR BOOT



aspen blue

Upgraded version of the SCOTT Cosmos Tour, this boot is the perfect blend of light weight, walkability and comfort for the demanding conditions of high-mountain skitouring. The new Cabrio Hybrid construction ensures easy mobility of the cuff for climbing and gives the skier solid support during turns. The Rear Hook Walk System is simple, strong, and dependable, delivering powerful energy transfer for skiing with a high range of walking mobility. The boot is made of a Grilamid® material and features a flex index of 120 AT. Buckles and tongue have been improved for easy handling and smooth step-in.

FLEX INDEX: 120
FORWARD LEAN: Adjustable 12° or 14°
CUFF ROTATION: 60°
CLOSURE: 3 Ergal® micro-adjustable buckles, Velcro Strap
LAST WIDTH: 103,5 mm
LINER: PWR Lite Tour
SYSTEM: ISO 9523 Touring (UNI)
APPROX. WEIGHT: 1350g (size 26.5)
SIZE: 25-31.5

- FEATURES**
- Adjustable forward lean
 - Dynafit® certified tech inserts
 - Lock catches
 - Rear Hook Ski/Walk Mechanism
 - Thermo and Memo fit liner foam
 - Vibram® bi-density rubber Soles

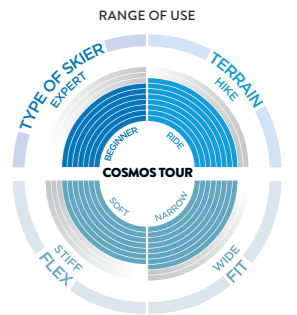

SCOTT CELESTE TOUR WOMEN'S BOOT

404865



glaze blue

Upgraded version of the the SCOTT Celeste Tour, this boot is designed specifically for women. A perfect blend of light weight, walkability and comfort for the demanding conditions of high-mountain ski-touring. The new Cabrio Hybrid construction ensures easy mobility of the cuff for climbing and gives the skier solid support during turns. The Rear Hook Walk System is simple, strong, and dependable, delivering powerful energy transfer for skiing with a high range of walking mobility. The boot is made of a Grilamid® material and features a flex index of 110 AT. Progression and comfort are the key benefits of this model. Buckles and tongue have been improved for easy handling and smooth step-in.

FLEX INDEX: 110
FORWARD LEAN: Adjustable 12° or 14°
CUFF ROTATION: 60°
CLOSURE: 3 Ergal® micro-adjustable buckles, Velcro Strap
LAST WIDTH: 103,5 mm
LINER: PWR Lite Tour
SYSTEM: ISO 9523 Touring (UNI)
APPROX. WEIGHT: 1200g (size 24.5)
SIZE: 23-27.5

- FEATURES**
- Dynafit® certified tech inserts
 - Adjustable forward lean
 - Lock catches
 - Thermo and Memo fit liner foam
 - Rear Hook Ski/Walk Mechanism
 - Vibram® bi-density rubber Soles

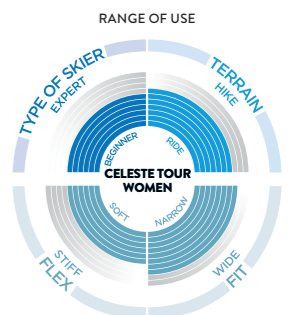

SCOTT COSMOS BOOT



The SCOTT Cosmos is a versatile touring boot. Lighter, with an increased range of motion due to the all-new Cabrio Hybrid construction, the new generation of Cosmos is made of Pebax® Rnew™ material and features a flex index of 110 AT. Progression and comfort are the key benefits of this model. Buckles and tongue have been improved for easy handling and smooth step-in.



metal blue

FLEX INDEX: 110
FORWARD LEAN: Adjustable 12° or 14°
CUFF ROTATION: 60°
CLOSURE: 3 Ergal® micro-adjustable buckles, Velcro Strap
LAST WIDTH: 103,5 mm
LINER: PWR Lite
SYSTEM: ISO 9523 Touring (UNI)
APPROX. WEIGHT: 1375g (size 26.5)
SIZE: 25-31.5

- FEATURES**
- Adjustable forward lean
 - Dynafit® certified tech inserts
 - Lock catches
 - Rear Hook Ski/Walk Mechanism
 - Thermo and Memo fit liner foam
 - Vibram® bi-density rubber Soles

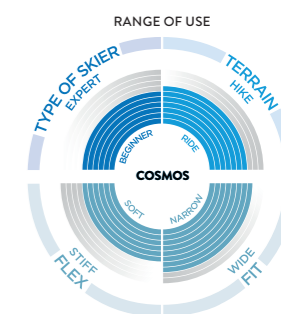

SCOTT CELESTE WOMEN'S BOOT

404866



The SCOTT Celeste is dedicated to the female skitourer and mountaineer, offering both a high level of comfort and a progressive and forgiving flex. This new generation is lighter and ensures better walkability due to the new Cabrio Hybrid construction. Made from Pebax® Rnew™, the Celeste features a flex index of 100 AT. Progression and comfort are the key benefits of this model. Buckles and tongue have been improved for easy handling and smooth step-in.



ice white

FLEX INDEX: 100
FORWARD LEAN: Adjustable 12° or 14°
CUFF ROTATION: 60°
CLOSURE: 3 Ergal® micro-adjustable buckles, Velcro Strap
LAST WIDTH: 103,5 mm
LINER: PWR Lite
SYSTEM: ISO 9523 Touring (UNI)
APPROX. WEIGHT: 1225g (size 24.5)
SIZE: 23-27.5

- FEATURES**
- Adjustable forward lean
 - Dynafit® certified tech inserts
 - Lock catches
 - Rear Hook Ski/Walk Mechanism
 - Thermo and Memo fit liner foam
 - Vibram® bi-density rubber Soles

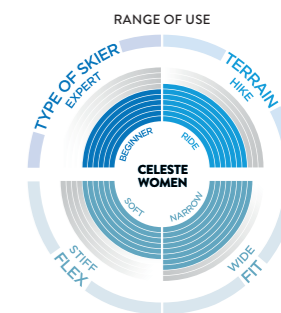

SCOTT ORBIT BOOT

412061



white

The SCOTT Orbit is a perfect entry-level touring boot for those who are looking to take their skiing into the backcountry. Light, with an increased range of motion due to the all-new Cabrio Hybrid construction, the new generation of Cosmos features a flex index of 110 AT. Comfort is the key of this model. Buckles and tongue have been improved for easy handling and smooth step-in.

FLEX INDEX: 100

FORWARD LEAN: Adjustable 12° or 14°

CUFF ROTATION: 60°

CLOSURE: 2 Ergal® micro-adjustable buckles, Power Strap buckle

LAST WIDTH: 103,5

LINER: PWR Lite Access

SYSTEM: ISO 9523 Touring (UNI)

APPROX. WEIGHT: 1330g (size 26.5)

SIZE: 23-31.5

FEATURES

- Adjustable forward lean
- Dynafit® certified tech inserts
- Lock catches
- Rear Hook Ski/Walk Mechanism
- Thermo and Memo fit liner foam
- Vibram® bi-density rubber Soles

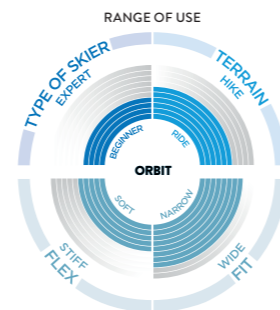

re source
by SCOTT



warm grey

SCOTT COSMOS RE-SOURCE BOOT

412062



RANGE OF USE

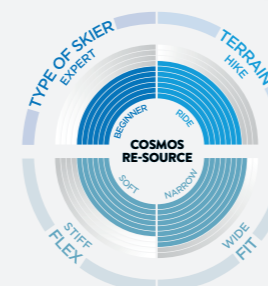

The brand new Cosmos Re-Source is the latest member of the growing Re-Source product family. Based on the iconic Cosmos design, this new ski boot uses more than 50% per weight of materials. With the same DNA, the versatility and the lightness place it as one of the best ski touring boots on the market. The all-new liner uses GRS certified fabrics, the shell and cuff are made of Pebax® Rnew® and the strap is made of 100% recycled polyester. Let's reduce our impact together!

FLEX INDEX: 110

FORWARD LEAN: Adjustable 12° or 14°

CUFF ROTATION: 60°

CLOSURE: 3 Ergal® micro-adjustable buckles, Velcro Strap

LAST WIDTH: 103,5 mm

LINER: PWR Lite Eco

SYSTEM: ISO 9523 Touring (UNI)

APPROX. WEIGHT: 1380g (size 26.5)

SIZE: 23.5-31.5 (half size only)

FEATURES

- Adjustable forward lean
- Dynafit® certified tech inserts
- Lock catches
- Rear Hook Ski/Walk Mechanism
- Thermo and Memo fit liner foam
- Vibram® bi-density rubber Soles

TELEMARK
BOOTS



stealth black

SCOTT VOODOO NTN SKI BOOT

277917



The SCOTT Voodoo NTN's lateral stiffness and supportive overlap work harmoniously with smooth, progressive forward flex. The Voodoo brings an ideal balance of precision and mobility for resort and backcountry telemarking.

FLEX INDEX: 130
FORWARD LEAN: 13° + free for walking
CUFF ROTATION: 60°
CLOSURE: 3 Ergal® micro-adjustable buckles, Velcro Strap
LAST WIDTH: 100 mm
LINER: PWR Telemark High
SYSTEM: NTN Standard
APPROX. WEIGHT: 1840g (size 27.5)
SIZE: 23-30.5

FEATURES
 • Lock catches
 • Dynafit® certified tech inserts

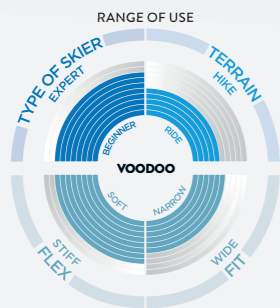

SCOTT VOODOO SKI BOOT



The SCOTT Voodoo's lateral stiffness and supportive overlap work harmoniously with smooth, progressive forward flex. The Voodoo brings an ideal balance of precision and mobility for resort and backcountry telemarking.

FLEX INDEX: 130
FORWARD LEAN: 13° + free for walking
CUFF ROTATION: 60°
CLOSURE: 3 Ergal® micro-adjustable buckles, Velcro Strap
LAST WIDTH: 75mm standard
LINER: PWR Telemark High
SYSTEM: 75mm
APPROX. WEIGHT: 1850g (size 27.5)
SIZE: 22-30.5

FEATURES
 • Lock catches



white/black

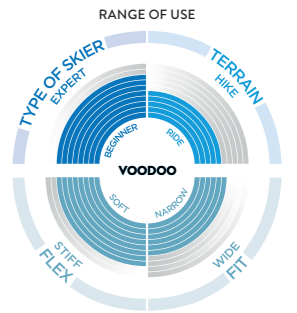

MONDO	22	22.5	23	23.5	24	24.5	25	25.5	26	26.5	27	27.5	28	28.5	29	29.5	30	30.5	31	31.5
SCOPE PRO					286		296		306		316		326		336					
SCOPE					286		296		306		316		326		336					
COSMOS PRO				266		276		286		296		306		316		326		336		346
COSMOS TOUR								286		296		306		316		326		336		346
COSMOS								286		296		306		316		326		336		346
CELESTE TOUR				266		276		286		296		306								
CELESTE				266		276		286		296		306								
ORBIT				266		276		286		296		306		316		326		336		346
COSMOS RE-SOURCE				266		276		286		296		306		316		326		336		346
VOODOO								305		315		325		335		345		355		
VOODOO NTN								296		306		316		326		336		346		



SCOTT ORIGIN POLE

414507



The Origin pole celebrates 65 years of SCOTT and pays tribute to the invention that gave birth to the brand in 1958. This limited edition pole is inspired by the very first SCOTT product, a ski pole that revolutionised the world of skiing by replacing bamboo and steel with aluminum. Now it's your turn to write the story.

- CONSTRUCTION:**
- 16mm Shaft Diameter
 - 7075 Alloy Shaft
 - Full Leather Waterproof
 - Natural Full Leather waterproof Adjustable
 - Natural Leather
 - Carbide Freeride Tip

SIZE (CM): 110, 120, 130

gold

SCOTT ZEO 14 SRS POLES

291880



Less is more. The SCOTT ZEO 14 SRS Pole has an improved feel and light swing weight due to the use of 100% Carbon fibers and offers the added safety benefit of the SRS strap.

- CONSTRUCTION:**
- 14mm Shaft Diameter
 - All Mountain M Basket (60mm)
 - Carbide Freeride Tip
 - Carbon Shaft
 - Notch Grip
 - PA Support Winter
 - SRS Mountain Strap

SIZE (CM): 110-135



black

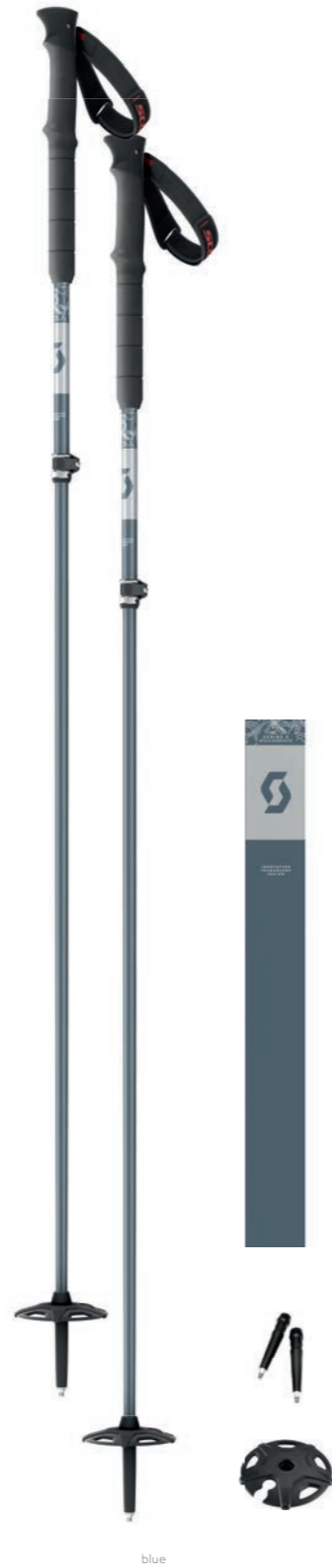

SCOTT PROGUIDE C SRS POLES 291892



The mountain guides' favorite – the all-new SCOTT Proguide C SRS is an ultralight, length-adjustable carbon shaft, equipped with safety straps and a long, comfortable foam grip for side-hilling.

- CONSTRUCTION:**
- 16-14mm Shaft Diameter
 - 2-Part Carbon Shaft
 - Carbide Touring Tip
 - Collapsed Length 105cm
 - EG Foam Grip
 - Foam Sleeve M
 - Freeride Basket (90mm)
 - Metal Locking Mechanism
 - PA Support Winter
 - SRS Mountain Strap
- SIZE (CM):** 105-140



SCOTT PROGUIDE SRS POLES 291893



The SCOTT Proguide SRS is a robust, length-adjustable alu shaft, equipped with safety straps and a long, comfortable foam grip for side-hilling. The best for tough touring trips.

- CONSTRUCTION:**
- 16-14mm Shaft Diameter
 - 2-Part Aluminum Alloy Shaft
 - 7075 Alloy Shaft
 - Carbide Touring Tip
 - Collapsed Length 81cm
 - EG Foam Grip
 - Foam Sleeve L
 - Freeride Basket (90mm)
 - Metal Locking Mechanism
 - PA Support Winter
 - Size Range 105-140cm
 - SRS Mountain Strap
- SIZE (CM):** 105-140



SCOTT ALUGUIDE POLES 291894



Everything you need in a classic and sturdy touring pole: adjustable length and long foam grip.

- CONSTRUCTION:**
- 18-16mm Shaft Diameter
 - 2-Part Aluminum Alloy Shaft
 - 5083 Alloy Shaft
 - Carbide Touring Tip
 - Easy Locking Mechanism
 - EG Foam Grip
 - Foam Sleeve L
 - Freeride Basket (90mm)
 - PA Support Winter
 - Touring Strap
- SIZE (CM):** 105-140

SCOTT POLE TECHNOLOGIES

Strap



SCOTT S.R.S. – STRAP RELEASE SYSTEM

The SCOTT S.R.S. is the next generation of safety technology in ski poles. The S.R.S. allows the strap to release from the grip of the pole in sketchy situations to prevent injury.

- + Releases quickly while pulling sharply upwards
- + Integrated system for best wearing comfort
- + Safety anywhere and anytime



STEP 1
Pull quickly upwards



STEP 2
The force of pulling up will release the strap insert



STEP 3
The strap insert will detach from the pole to minimize injury

Shaft

SCOTT Shaft Technology was created when we built the first aluminum pole back in 1958. For over 60 years SCOTT has gone beyond the industry standard to introduce carbon fiber and aluminum systems into our ski poles to make them the best in the world.



Aluminum technology

ELECTROSTATIC PAINT PROCESS

SCOTT aluminum ski poles undergo an electrostatic paint process, delivering a clean, contemporary, highly durable finish.

SWAGED SHAFTS

SCOTT aluminum ski pole shafts are engineered with an exclusive “swage”, giving the pole a dual-taper design. Swaging is a process that utilizes a series of dies to reduce the outside diameter (creating the taper) and to increase wall thickness (adding strength). The taper results in an improved aerodynamic profile, lighter swing weight, and increased strength.



7075 ALUMINIUM

SCOTT aluminum ski poles undergo an electrostatic paint process, delivering a clean, contemporary, highly durable finish. They are constructed with the strongest aircraft-grade aluminum-zinc alloy commercially available, which has been heat treated and aged in order to confer its excellent properties. S4 aluminum poles are twice as strong as the industry standard and possess a very high strength-to-weight ratio.



ALUMINIUM 5083 AND BI MATERIAL GRIP

S3 aluminum shafts are computer engineered and manufactured with high-grade aluminum. This magnesium aluminum alloy has been strain hardened to confer high strength and good resistance.



ALUMINIUM 5083 AND MONO MATERIAL GRIP

S2 aluminum shafts utilize the same technical swaging and design features found in the S4 and S3 series. These poles have a great quality-to-price ratio, with good resistance and strength.

Carbon in scott poles



CARBON FIBERS IN SCOTT WINTERSPORTS

SCOTT uses Carbon Construction as carbon is a strong yet lightweight material that never sacrifices performance. Light, stiff and with unmatched performance, Carbon Construction is used in SCOTT skis, poles and boots because there are no shortcuts to building a better product.

30% CARBON FIBER

Pro Taper poles integrate a carbon matrix design for a good balance between carbon fiber's high strength and glass fiber's flexibility and durability. The Pro Taper includes 70% glass fiber for higher flexibility while staying lightweight and strong.

100% GLASS FIBER

The filament-wound glass fiber poles possess high strength and great flexibility for extreme durability. They will withstand any beating that a skier throws their way.

100% CARBON FIBER

Carbon fiber, with its minimal weight and significant strength, processed using a filament winding technique, is an ideal material for ski pole shafts. Carbon fiber reduces vibration and absorbs shock while improving feel and providing the best swing weight.

HELMETS

re source
by SCOTT



white/black

SCOTT COULOIR TOUR

400279



raw black

radium yellow/blue

A lightweight, touring-specific winter helmet used by our most winter athletes. Designed to work with a beanie, this helmet is made with over 55% recycled material. The EPS, straps and vent plates are all made using recycled waste. This helmet keeps you safe while reducing the impact on our playground.

RANGE OF USE: Touring
CONSTRUCTION: PC In-mold with EPS liner & PC bottom wrap
FIT SYSTEM: Halo 270
APPROX. WEIGHT: 350g
SIZE: S, M, L

FEATURES:

- Lightweight construction
- Ski standard
- Performance touring padding that can be used with a beanie
- Passive Venting System
- Headlamp fixation

ECO-FEATURES:

- Re-source by SCOTT product
- 100% Recycled EPS liner
- 100% Recycled PES webbing
- 100% Recycled PC vent plates, More than 55% Eco-content by weight

SCOTT CHASE 2 HELMET

271754



The SCOTT Chase 2 is the perfect match for everyday skiing. It ensures freshness on a sunny day and provides warmth during the more chilly days thanks to the active venting.

RANGE OF USE: All Mountain, Freeride
CONSTRUCTION: PC In-mold with EPS liner & PC bottom wrap
FIT SYSTEM: WRAS 2 Fit System
SIZE: S, M, L

FEATURES:

- 360° Pure Sound Technology
- Active Venting System



aspen blue



black

light beige

white

glacial blue



SCOTT HELMET TECHNOLOGIES & FIT SYSTEMS

CONSTRUCTION



PC IN-MOLD CONSTRUCTION
 + Lighter, more comfortable and better aesthetic
 + A polycarbonate shell fused with an impact-absorbing foam liner



ABS CONSTRUCTION
 + Durable and strong
 + ABS outer shell paired with an EPS liner

VENTING

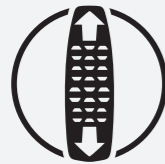

DUAL ACTIVE VENTING SYSTEM
 Our most advanced venting system allows the user to carefully regulate the airflow through the helmet for optimal ventilation in any weather condition. This is achieved through two easy-to-use sliders that allow the ventilation to be fine-tuned at the front and top of the helmet.



ACTIVE VENTING SYSTEM
 This system revolves around one easy-to-use slider that opens or closes multiple venting holes, allowing the user to optimally regulate ventilation in all weather conditions.



PASSIVE VENTING SYSTEM
 Built-in system regulating the airflow through the helmet.

FIT SYSTEMS

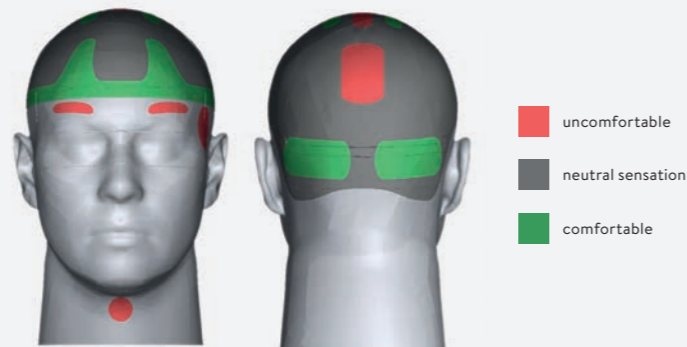

HALO 270 FIT SYSTEMS
 Our ultra-light HALO Fit System provides easy adjustability and unparalleled comfort. Find the perfect height of the rear ergonomic cradle while the helmet is on your head and dial in optimal pressure using the micro-adjustment dial. The result is a helmet which adapts to your head shape and leaves you feeling secure and focusing on the line ahead.



THE WRAS FIT SYSTEM
 offers full adjustability to ensure a customized and comfortable fit for your head shape. Adjust the height of the rear ergonomic cradle and dial in the perfect pressure using the micro adjustment dial. WRAS is forseen of a big comolded wheel that makes it easy to grab and adjust with gloves. WRAS ensures your helmet fits securely and comfortably.



JRAS FIT SYSTEM
 can be adjusted vertically allowing you to keep your helmet secure whilst skiing.

SCOTT SAFETY TECHNOLOGIES



WE ARE EXPERTS AT MAKING HELMETS THAT KEEP YOU SAFE



MOLECULES FLOW FREELY
 Soft and flexible material



MOLECULES LOCK
 Absorbs and dissipates impact energy

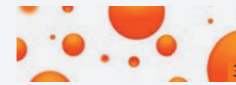

MOLECULES FLOW FREELY
 Returns to flexible state

D30® TECHNOLOGY
 Progressive impact absorption
 An extremely shock-absorbing material that remains soft and flexible:

- + Reduces the risk of concussion in low-energy impacts
- + Reduces the risk of brain injuries in mid-energy impacts
- + Allows for multiple low- and mid-energy impacts
- + Works hand in hand with EPS in high-energy impacts

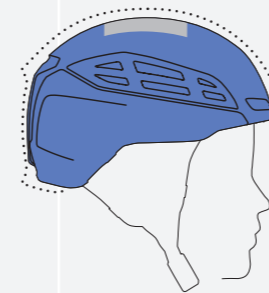

CASIDION® TECHNOLOGY
 + Increased protection in bigger impacts
 + Outperforms EPS foam in terms of impact absorption
 + Reduced stand-off

- Casidion® insert
- Thickness of the SCOTT Couloir
- Thickness of the SCOTT Couloir 2

360



360° PURE SOUND TECHNOLOGY
 An exclusive SCOTT technology
 + Hear better, hear more
 + Specifically shaped inner piece increases sound localization
 + Rubber insert with perforations surrounded by transparent fabric

Mips

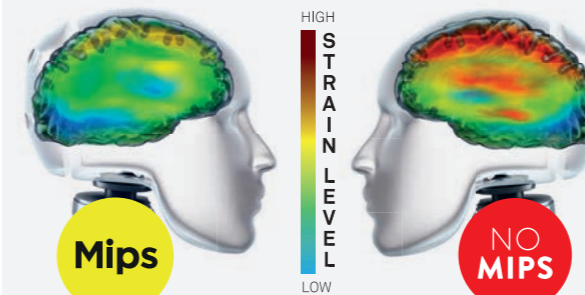

MIPS® TECHNOLOGY
 + MIPS® is a unique technology intended to protect your brain against angular impacts
 + Reduces the rotational violence transmitted to the brain

GOGGLES

THE ALL-NEW AMP PRO

THE MOST INNOVATIVE LENS TECHNOLOGY SCOTT HAS EVER DEVELOPED

Its distinctive natural green base improves contrast in low visibility while staying true to color and reducing the strain in your eyes. The unique AMP pro white chrome coat makes it SCOTT's most versatile lens, suiting both "blue bird" and mixed overcast conditions.



WHAT YOU NEED TO KNOW

AMP PRO



WHITE CHROME



GREEN







SCOTT AMP PRO* LENS TECHNOLOGY COMBINES:

- Amplified contrast that highlights every detail, even in low-light conditions
- Increased vision with a natural true to colors tint
- Lens made out of aprx. 50% renewable resources
- Improved comfort to reduce the strain in your eyes

*patent pending



TRY IT IN
AUGMENTED
REALITY

DISCOVER THE AMP PRO COLLECTION



- SPHERE OTG AMP PRO -



- REACT AMP PRO -



- SHIELD AMP PRO -

WHAT YOU NEED TO KNOW

REACT

DESIGN MEETS PERFORMANCE WITH A FULLY INTEGRATED MAGNETIC LENS CHANGE SYSTEM

The new SCOTT REACT goggle is our first fully integrated magnetic lens change goggle. With the magnetic system, the lens change handling is intuitive and easy, even with gloves. The React stands out with its clean style and is one of the first goggles featuring our brand new AMP pro lens technology, offering the best contrast we've achieved so far. All React goggles come with 2 different lenses, so that you always have the best vision no matter if it is blue bird or white out. Its clever design offers an ultra-wide range of vision and perfect face fit and comfort, thanks to the NoSweat microfibre Technology.

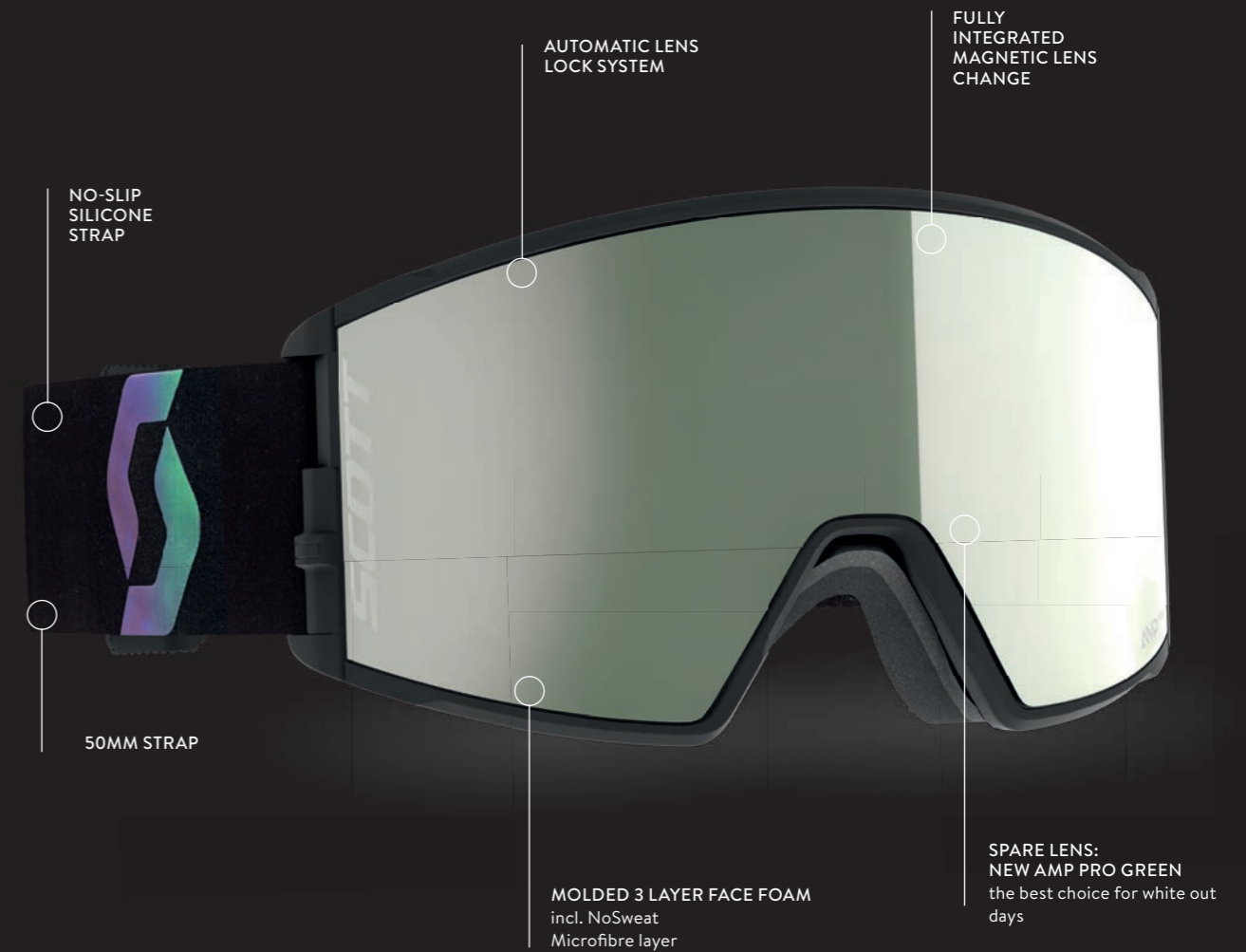

REACT SERIES

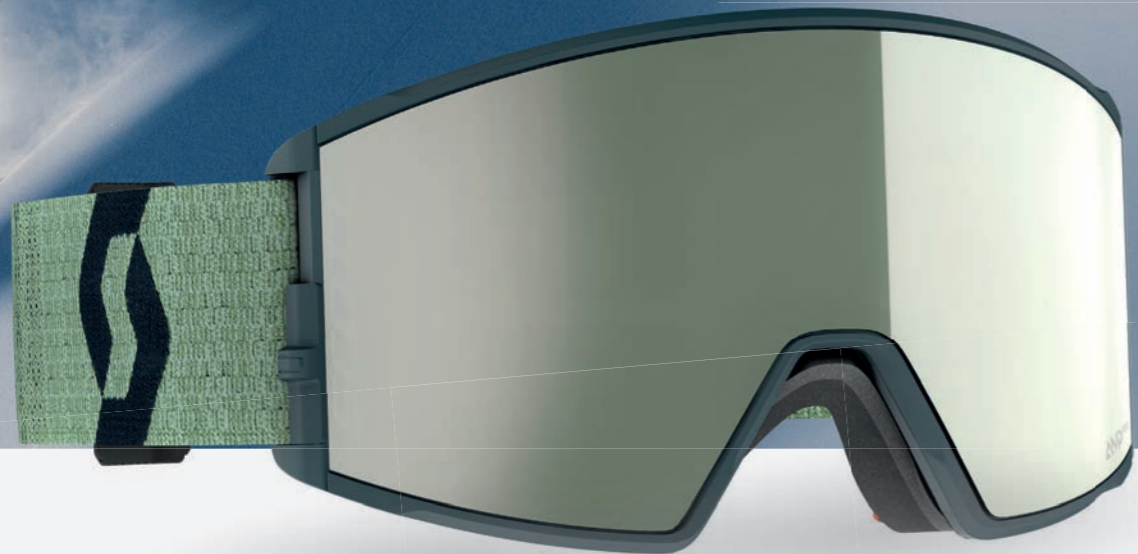

soft green/black | amp pro white chrome



SCOTT REACT AMP PRO GOGGLE

414504



See the invisible. Indeed, the SCOTT REACT, SCOTT's first fully integrated magnetic lens goggle, will be available with two all-new AMP Pro lenses. Its distinctive natural green base improves contrast in low visibility while staying true to colour and reducing eye fatigue. The unique AMP Pro white chrome coat makes it SCOTT's most versatile lens, suiting both "blue bird" and mixed overcast conditions. The additional lens, coming without chrome, is your weapon of choice in those hard-to-navigate white out days. Focus only on your skiing. The clever glasses-compatible goggle design provides an ultra-wide field of vision and a perfect comfort and fit thanks to the NoSweat Microfibre facefoam. Furthermore, the magnetic system makes the handle of the lens change intuitive, safe and easy, even with gloves.

EXTRAS:



FIT: Medium to Large

TECHNOLOGIES:

- Fully integrated magnetic Lens Change System
- Automatic Lens Lock System
- NoSweat 3-layer molded face foam
- Extra wide no-slip silicone strap

LENS TECHNOLOGIES:

- 100% UV Protection
- Cylindrical Lens
- Lens 1: SCOTT AMP pro white chrome (Cat. S2)
- Lens 2: SCOTT AMP pro green (Cat. S1)
- NoFog™ Anti-Fog lens treatment
- SCOTT AMP pro lens technology

EXTRAS:

- Spare lens included (Cat. S1)
- Goggle cover
- MicroFiber Goggle bag
- Cylindrical molded lens case



black/aurora green
amp pro white chrome

mineral black/white
amp pro white chrome



mineral black/white | light sensitive bronze chrome



SCOTT REACT LIGHT SENSITIVE GOGGLE

414502



This goggle stands out for its unbeatable versatility. Equipped with SCOTT's light-sensitive photochromic technology, the lens automatically adjusts to the light conditions. The 2nd lens features SCOTT's all-new AMP Pro technology. The sleek and modern style of the SCOTT REACT goggle offers a fully integrated magnetic lens changing system that makes handling easy, safe and intuitive, even when wearing gloves. Its clever glasses-compatible design provides an ultra-wide field of vision. You will also like the ultimate NoSweat microfibre face foam for a perfect comfort and fit.

EXTRAS:



FIT: Medium to Large

TECHNOLOGIES:

- Fully integrated magnetic Lens Change System
- Automatic Lens Lock System
- NoSweat 3-layer molded face foam
- Extra wide no-slip silicone strap

LENS TECHNOLOGIES:

- 100% UV Protection
- Cylindrical Lens
- Lens 1: SCOTT Light Sensitive lens (CAT.S2 to S3 – red chrome) or (CAT.S2 to S4 – blue chrome)
- Lens 2 : SCOTT AMP pro lens (CAT.S1) or bronze chrome (cat.S1-S3)
- NoFog™ Anti-Fog lens treatment
- SCOTT AMP LS Lens Technology
- SCOTT AMP pro Lens Technology

EXTRAS:

- Spare lens included (Cat. S1)
- Goggle cover
- Microfiber Goggle bag
- Cylindrical molded lens case



mineral black
light sensitive blue chrome

mineral white
light sensitive red chrome

soft green/black
light sensitive blue chrome



mineral black | solar black chrome



SCOTT REACT GOGGLE

414503



The SCOTT REACT is SCOTT's first fully integrated magnetic lens change goggle. Thanks to the magnetic system, the lens change handling is intuitive and easy, even with gloves. The REACT stands out by its modern and clean style and comes equipped with one standard Amplifier lens and a second bad weather lens featuring the latest SCOTT AMP Pro lens technology. Its clever and glasses-compatible design offers an ultra-wide range of vision and perfect comfort and fit, featuring the NoSweat facefoam microfibre layering.

EXTRAS:



FIT: Medium to Large

TECHNOLOGIES:

- Fully integrated magnetic Lens Change System
- Automatic Lens Lock System
- NoSweat 3-layer molded face foam
- Extra wide no-slip silicone strap

LENS TECHNOLOGIES:

- 100% UV Protection
- Cylindrical Lens
- Lens 1: SCOTT Enhancer lens (CAT.S2) or Solar lens (CAT.S3)
- Lens 2: SCOTT AMP pro lens (CAT.S1)
- NoFog™ Anti-Fog lens treatment
- SCOTT AMP LS Lens Technology
- SCOTT AMP pro Lens Technology

EXTRAS

- Spare lens included (Cat. S1)
- Goggle cover
- Microfiber Goggle bag
- Cylindrical molded lens case



soft green/black | amp pro white chrome



SCOTT SHIELD AMP PRO GOGGLE

414497



The SCOTT Shield is one of SCOTT's most iconic goggles and it is now available with the all-new AMP Pro lens. Its typical natural green base improves contrast in low visibility, stays true to colour and reduces eye fatigue. The unique AMP Pro white chrome coat creates the most versatile lens, suiting both "blue bird" and mixed overcast conditions. From now on the Shield will bring you the ultimate vision no matter the terrain.

FIT: Medium to Large

TECHNOLOGIES:

- 3-layer molded face foam
- Extra wide no-slip silicone strap

LENS TECHNOLOGIES:

- 100% UV Protection
- Cylindrical Lens
- SCOTT AMP pro lens (CAT.S2)
- NoFog™ Anti-Fog lens treatment
- SCOTT AMP pro lens technology

EXTRAS

- Microfiber Goggle bag



mineral black
enhancer red chrome

mineral black/white
enhancer teal chrome

mineral white
enhancer teal chrome

team white/black
enhancer aqua chrome



black/aurora green
enhancer teal chrome

beige/blue
enhancer yellow chrome

soft green/black
solar red chrome

lavender purple
enhancer teal chrome



mineral black/white
amp pro white chrome

black/aurora green
amp pro white chrome



mint green/neon pink | enhancer aqua chrome



SCOTT SHIELD GOGGLE

277837



The SCOTT Shield is one of our most iconic goggles. With a unique semi-frameless design and large cylindrical lens that offers perfect fit with most helmets, the Shield has been designed to maximize field of vision. Combined with a wider strap for unmatched style and SCOTT's proprietary Amplifier Lens Technology, the Shield is ready to bring ultimate vision for any terrain.

- | | |
|--|---|
| <p>FIT: Medium to Large</p> <p>TECHNOLOGIES:</p> <ul style="list-style-type: none"> • 3-layer molded face foam • Extra wide no-slip silicone strap <p>LENS TECHNOLOGIES:</p> <ul style="list-style-type: none"> • 100% UV Protection | <ul style="list-style-type: none"> • Cylindrical Lens • Lens 1: SCOTT Enhancer lens (CAT.S2) or Illuminator lens (CAT.S1) • NoFog™ Anti-Fog lens treatment • SCOTT AMP Lens Technology <p>EXTRAS</p> <ul style="list-style-type: none"> • Microfiber Goggle bag |
|--|---|



black/aurora green
enhancer teal chrome



mineral black/white
enhancer teal chrome



lavender purple
enhancer teal chrome



yellow/white | enhancer



SCOTT JUNIOR AGENT GOGGLE

271829 | AGENT DL 271837



The Junior Agent is perfect for all the little shredders out there, optimized for smaller faces. It comes with single-layer face foam and a cylindrical SCOTT TruView single lens.

- | | |
|---|--|
| <p>FIT: Kid</p> <p>TECHNOLOGIES:</p> <ul style="list-style-type: none"> • Single-layer face foam | <p>LENS TECHNOLOGIES:</p> <ul style="list-style-type: none"> • 100% UV Protection • Cylindrical Lens • NoFog™ Anti-Fog lens treatment • SCOTT AMP Lens Technology • SCOTT AMP Lens Technology • SCOTT Enhancer lens (CAT.S2) • ACS Air Control System (271837) |
|---|--|



white/grey
enhancer



blue/white
enhancer



pink/white
enhancer



black/orange
enhancer

LENS OPTIONS

Each category of lens comes with SCOTT's proprietary Contrast-Enhancing (FORMAT) lens technology: AMPLIFIER.

CLEAR LENSES

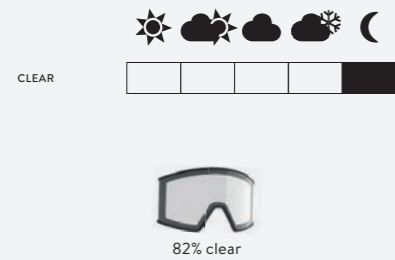

AMP

Amplifier lens technology utilizes a unique light transmission curve to optimize contrast and clarity.

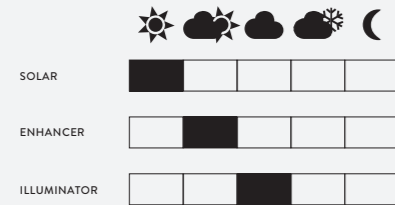
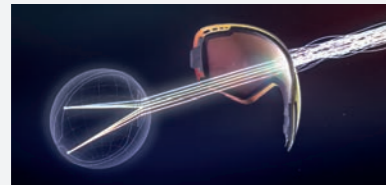

AMPLIS

SCOTT amp ls adapts the lens tint for the best contrast in all conditions.

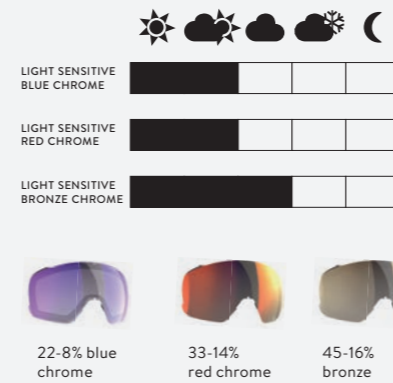
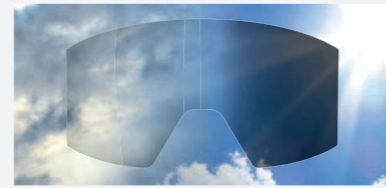

AMP PRO

SCOTT AMP PRO[®] LENS TECHNOLOGY COMBINES:

- Amplified contrast that highlights every detail, even in low-light conditions.
 - Increased vision with a natural true to colors tint
 - Lens made out of aprx. 50% renewable resources.
 - Improved comfort to reduce eye fatigue
- *patent pending*

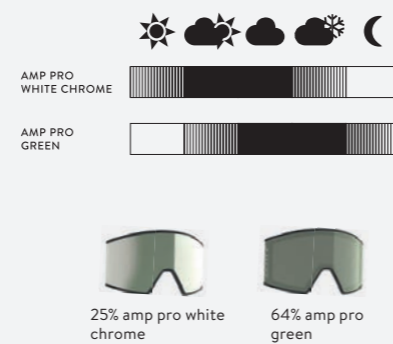

LENS OPTIONS



Lens shapes

- 1. SPHERICAL LENS**
Spherical lenses are manufactured to mimic the shape of the human eye in order to provide superior vision in all directions. A greater chamber volume also helps to prevent fogging.
- 1. CYLINDRICAL LENS**
Cylindrical lenses curve from left to right and are flat from top to bottom. These are low profile, flexible, and offer a unique look.

Fog resistance

- 4. ANTI-FOG COATING**
SCOTT lenses undergo a permanent NoFog™ treatment process to prevent condensation and fogging.
- 5. SPACER FOAM AND DOUBLE LENSES**
Spacer Foam and Double Lenses block moisture and eliminate fogging, while allowing for optimal breathability.
- 6. AIR CONTROL SYSTEM (ACS)**
ACS ventilation incorporates lens air intake vents on the goggle lens and frame air outtake vents on the bottom of the goggle.

External coatings

- 2. HARD COATING**
SCOTT hard coating creates a permanent bond with the lens that reduces the appearance of hairline scratches and provides overall lens durability.
- 3. CHROME COATING**
SCOTT chrome coating offers unmatched style for your goggles while controlling light transmittance.

SUNGLASSES

PERFORMANCE SUNGLASSES



tortoise brown
grey

SCOTT CERVINA SUNGLASSES

283656



black
red chrome



white
brown



black
grey



teal blue/white
red chrome

The SCOTT Cervina sunglasses are our latest glacier protection sunglasses that bring the vintage mountain DNA into a stylish and modern look. Featuring removable parts made from soft, long-lasting fabric for multi-season usage, they come in a unisex size, with a leash – all of which is packaged in a nice retro case.

FIT: For medium to large faces

FRAME TECHNOLOGIES:

- Detachable parts (blinders and nose) made from soft, long-lasting fabric
- Detachable leash
- No-slip soft nose pads
- Leash holes on temples
- Hinge flex construction

LENS TECHNOLOGIES:

- Category 4 lens
- Base 6
- 100% UV protection

EXTRAS

- Retro Glacier case
- Special cleaning cloth
- Detachable Leash

APPROX. WEIGHT: 35g

LENS WIDTH: 59mm

LENS HEIGHT: 49mm

ARM LENGTH: 135mm

SCOTT SPUR MULTI-LENS CASE SUNGLASSES



black matt
grey + clear + red enhancer

The SCOTT Spur Multi-Lens Case Sunglasses represent a step further in performance eyewear. The innovative design, with its XL lens creating a perfect shield, is largely focused on protection. The low-profile branches are specifically designed to fit well with helmets, offering added coverage over the temples for optimal comfort. Additionally, the SCOTT Spur features the ELC system, which allows you to switch lenses quickly and easily. The Spur comes with three lenses: a clear one for riding at night or in bad weather, a red chrome Amplifier that enhances contrast in low light and a grey lens that blocks high-intensity rays, thereby reducing eye fatigue on sunny days. These sunglasses also have an adjustable nose piece, and come with a sport multi-lens case and microfiber bag for convenient storage.

FIT: For medium to large faces

FRAME TECHNOLOGIES:

- SCOTT Fusion Frame
- ELC lens change system
- Optimized helmet integration
- No-slip adjustable nose piece
- No-slip temple ends

LENS TECHNOLOGIES:

- Impact protection
- Maximal field of vision
- Extra large lens coverage
- ACS Air Control System
- 100% UV protection

EXTRAS

- Two spare lenses included
- Sport multi-lens case with microfiber bag

APPROX. WEIGHT: 34g

LENS WIDTH: 135mm

LENS HEIGHT: 47mm

ARM LENGTH: 111mm

SCOTT SPUR LIGHT SENSITIVE SUNGLASSES

273337



black matt
grey light sensitive + clear

The SCOTT Spur Light Sensitive sunglasses represent a step further in performance eyewear. The light-sensitive, photochromatic lens is self-tinting and adapts automatically to sunlight intensity, which makes it perfect for all weather conditions. The innovative design, with its XL lens creating a perfect shield, is largely focused on protection. The low-profile branches are specifically designed to fit well with helmets, offering added coverage over the temples for optimal comfort. Additionally, the SCOTT Spur features the ELC system, which allows you to switch lenses quickly and easily. These sunglasses come with a spare clear lens for riding at night. They also have an adjustable nose piece, and come with a hard case and microfiber bag for convenient storage.

FIT: For medium to large faces

FRAME TECHNOLOGIES:

- SCOTT Fusion Frame
- ELC lens change system
- Optimized helmet integration
- No-slip adjustable nose piece
- No-slip temple ends

LENS TECHNOLOGIES:

- SCOTT Light Sensitive photochromic technology
- Impact protection
- Maximal field of vision
- Extra large lens coverage
- ACS Air Control System
- 100% UV protection

EXTRAS

- Spare clear lens included
- Hard case with microfiber bag

APPROX. WEIGHT: 34g

LENS WIDTH: 135mm

LENS HEIGHT: 47mm

ARM LENGTH: 111mm



kaki green
grey light sensitive + clear

SCOTT SPUR SUNGLASSES

266006



The SCOTT Spur Sunglasses represent a step further in performance eyewear. The innovative design, with its XL lens creating a perfect shield, is largely focused on protection. The Spur offers maximum coverage in order to protect your eyes from wind and various flying debris from the ground. The low-profile branches are specifically designed to fit well with helmets, offering added coverage over the temples for optimal comfort. Additionally, the SCOTT Spur features the ELC system, which allows you to switch lenses quickly and easily. It comes with a spare lens, an adjustable nose piece and a hard case with a microfiber bag.

- FIT:** For medium to large faces
- FRAME TECHNOLOGIES:**
- SCOTT Fusion Frame
 - ELC lens change system
 - Optimized helmet integration
 - No-slip adjustable nose piece
 - No-slip temple ends
- LENS TECHNOLOGIES:**
- Impact protection
 - Maximal field of vision
 - Extra large lens coverage
 - ACS Air Control System
 - 100% UV protection
- EXTRAS:**
- Spare clear lens included
 - Hard case with microfiber bag
- APPROX. WEIGHT:** 34g
LENS WIDTH: 135mm
LENS HEIGHT: 47mm
ARM LENGTH: 111mm



black matt/orange red chrome enhancer + clear



black/yellow gold chrome

black matt grey + clear

kaki green red chrome enhancer + clear

submariner blue gold chrome + clear

soft teal green green chrome + clear

SCOTT PRO SHIELD LIGHT SENSITIVE SUNGLASSES

289231



Designed for racers and built for speed. Special ventilation holes provide superior ventilation without sacrificing wind protection for your eyes. Complemented with nose and temple fit systems for better comfort and fit, the Pro Shield Sunglasses will bring your vision to the next level. The light-sensitive, photochromatic lens is self-tinting and covers categories 1-3.

- FIT:** For medium to large faces
- FRAME TECHNOLOGIES:**
- SCOTT Fusion Frame
 - Interchangeable lenses
 - Optimized helmet integration
 - No-slip adjustable nose piece
 - Wire temples Fit System
 - No-slip temple ends
 - SCOTT icon metallic insert
- LENS TECHNOLOGIES:**
- SCOTT Light Sensitive photochromic technology
 - Impact protection
 - Maximal field of vision
 - Extra-large lens coverage
 - ACS Air Control System
 - High level of ventilation
 - 100% UV protection
 - SCOTT laser print
- EXTRAS:**
- Hard case with microfiber bag
- APPROX. WEIGHT:** 32g
LENS WIDTH: 133mm
LENS HEIGHT: 61mm
ARM LENGTH: 118mm



black matt grey light sensitive



yellow matt grey light sensitive

SCOTT PRO SHIELD SUNGLASSES

SCOTT 289232



Designed for racers and built for speed. Special ventilation holes provide superior ventilation without sacrificing wind protection for your eyes. Complemented with nose and temple fit systems for better comfort and fit, the Pro Shield Sunglasses will bring your vision to the next level.

- FIT:** For medium to large faces
- FRAME TECHNOLOGIES:**
- SCOTT Fusion Frame
 - Interchangeable lenses
 - Optimized helmet integration
 - No-slip adjustable nose piece
 - Wire temples Fit System
 - No-slip temple ends
 - SCOTT icon metallic insert
- LENS TECHNOLOGIES:**
- Impact protection
 - Maximal field of vision
 - Extra-large lens coverage
 - ACS Air Control System
 - High level of ventilation
 - 100% UV protection
 - SCOTT laser print
- EXTRAS:**
- Hard case with microfiber bag
- APPROX. WEIGHT:** 32g
LENS WIDTH: 133mm
LENS HEIGHT: 61mm
ARM LENGTH: 118mm



white matt red chrome



black grey

black red chrome

black clear

submariner blue blue chrome enhancer

marble black teal chrome

soft teal green green chrome

SCOTT SHIELD LIGHT SENSITIVE SUNGLASSES

275379



Race ready and stylish, all in one piece. Pairing a frameless, cylindrical design with a massive field of vision, the Shield covers the rider's eyes seamlessly and comfortably. The light-sensitive, photochromatic lens is self-tinting and covers categories 1-3.

- FIT:** For medium to large faces
- FRAME TECHNOLOGIES:**
- SCOTT Fusion Frame
 - Interchangeable lenses
 - Optimized helmet integration
 - No-slip adjustable nose piece
 - No-slip temple ends
- LENS TECHNOLOGIES:**
- SCOTT Light Sensitive photochromic technology
 - Impact protection
 - Maximal field of vision
 - Extra large lens coverage
 - 100% UV protection
 - SCOTT laser print
- EXTRAS:**
- Hard case with microfiber bag
- APPROX. WEIGHT:** 33g
LENS WIDTH: 145mm
LENS HEIGHT: 61mm
ARM LENGTH: 115mm



black matt grey light sensitive



yellow matt grey light sensitive

SCOTT SHIELD SUNGLASSES

275380



Race ready and stylish, all in one piece. Pairing a frameless, cylindrical design with a massive field of vision, the Shield covers the rider's eyes seamlessly and comfortably.

- FIT:** For medium to large faces
- APPROX. WEIGHT:** 33g
- FRAME TECHNOLOGIES:**
- SCOTT Fusion Frame
 - Interchangeable lenses
 - Optimized helmet integration
 - No-slip adjustable nose piece
 - No-slip temple ends
- LENS TECHNOLOGIES:**
- Impact protection
 - Maximal field of vision
 - Extra large lens coverage
 - 100% UV protection
 - SCOTT laser print
- EXTRAS**
- Hard case with microfiber bag



black matt
blue chrome enhancer



black matt
grey

white matt
red chrome

kaki green
green chrome

submariner blue
gold chrome

marble black
teal chrome

soft teal green
green chrome

SCOTT SHIELD COMPACT SUNGLASSES



The Shield, just smaller. The Shield Compact is optimized to fit smaller faces. The lens is 4mm narrower compared to the Shield, which brings the frame closer to the face and ensures the best fit. Race ready and stylish, all in one piece. Pairing a frameless, cylindrical design with a massive field of vision, the Shield Compact Sunglasses cover the rider's eyes seamlessly and comfortably.

- FIT:** For small to medium faces
- APPROX. WEIGHT:** 33g
- FRAME TECHNOLOGIES:**
- SCOTT Fusion Frame
 - Interchangeable lenses
 - Optimized helmet integration
 - No-slip adjustable nose piece
 - No-slip temple ends
 - Special fit for small faces
- LENS TECHNOLOGIES:**
- Impact protection
 - Maximal field of vision
 - Extra large lens coverage
 - 100% UV protection
 - SCOTT laser print
- EXTRAS**
- Hard case with microfiber bag



soft teal green
green chrome



black matt
grey

white matt
red chrome

kaki green
green chrome

submariner blue
gold chrome

marble black
teal chrome

black matt
blue chrome enhancer

SCOTT SHIELD COMPACT LIGHT SENSITIVE SUNGLASSES

289234



The Shield, just smaller. The Shield Compact is optimized to fit smaller faces. The lens is 4mm narrower compared to the Shield, which brings the frame closer to the face and ensures the best fit. Race ready and stylish, all in one piece. Pairing a frameless, cylindrical design with a massive field of vision, the Shield Compact Sunglasses cover the rider's eyes seamlessly and comfortably. The light-sensitive, photochromatic lens is self-tinting and covers categories 1-3.

- FIT:** For small to medium faces
- APPROX. WEIGHT:** 33g
- FRAME TECHNOLOGIES:**
- SCOTT Fusion Frame
 - Interchangeable lenses
 - Optimized helmet integration
 - No-slip adjustable nose piece
 - No-slip temple ends
 - Special fit for small faces
- LENS TECHNOLOGIES:**
- SCOTT Light Sensitive photochromic technology
 - Impact protection
 - Maximal field of vision
 - Extra large lens coverage
 - 100% UV protection
 - SCOTT laser print
- EXTRAS**
- Hard case with microfiber bag



black matt
grey light sensitive



yellow matt
grey light sensitive

SCOTT SPORT SHIELD LIGHT SENSITIVE SUNGLASSES

289233



The Sport Shield Sunglasses that were originally introduced in 1989 are back and better than ever! The updated shape brings together modern technologies and vintage DNA to bring out the best of these iconic shades. The light-sensitive, photochromatic lens is self-tinting and covers categories 1-3.

- FIT:** For medium to large faces
- APPROX. WEIGHT:** 32g
- FRAME TECHNOLOGIES:**
- SCOTT Fusion Frame
 - Interchangeable lenses
 - Optimized helmet integration
 - No-slip adjustable nose piece
 - No-slip temple ends
- LENS TECHNOLOGIES:**
- SCOTT Light Sensitive photochromic technology
 - Impact protection
 - Maximal field of vision
 - Extra large lens coverage
 - 100% UV protection
- EXTRAS**
- Microfiber bag



black
grey light sensitive

SCOTT SPORT SHIELD SUNGLASSES

281188



marble black
teal chrome



black
red chrome



white matt
red chrome



black
clear



soft teal green
green chrome

The Sport Shield Sunglasses that were originally introduced in 1989 are back and better than ever! The updated shape brings together modern technologies and vintage DNA to bring out the best of these iconic shades.

FIT: For medium to large faces

FRAME TECHNOLOGIES:

- SCOTT Fusion Frame
- Interchangeable lenses
- Optimized helmet integration
- No-slip adjustable nose piece
- No-slip temple ends

LENS TECHNOLOGIES:

- Impact protection
- Maximal field of vision
- Extra large lens coverage
- 100% UV protection

EXTRAS

- Microfiber bag

APPROX. WEIGHT: 32g

LENS WIDTH: 153mm

LENS HEIGHT: 61mm

ARM LENGTH: 118mm

SCOTT VECTOR SUNGLASSES



grey
red chrome



black matt
clear



black matt
grey



submariner blue
gold chrome



soft teal green
green chrome

The SCOTT Vector is the perfect blend of performance and lifestyle, made for activities on and off the mountain. The large lens design not only offers a massive field of vision and blocks 100% of UV light, but also protects you from wind and various flying debris. With a construction that avoids pressure points, these shades are as comfy as they get. Grab a pair of Vectors and get out there!

FIT: For small to medium faces

FRAME TECHNOLOGIES:

- SCOTT Fusion Frame
- Low pressure temple tip rubber
- No-slip soft nose pads

LENS TECHNOLOGIES:

- Impact protection
- Base 7
- Maximal field of vision
- Extra large lens coverage
- ACS Air Control System
- 100% UV protection

EXTRAS

- Hard case with microfiber bag

APPROX. WEIGHT: 32g

LENS WIDTH: 68mm

LENS HEIGHT: 42mm

ARM LENGTH: 120mm

SCOTT VECTOR LIGHT SENSITIVE SUNGLASSES

273339



black matt
grey light sensitive

The SCOTT Vector Light Sensitive is the perfect blend of performance and lifestyle, made for activities on and off the mountain. The large lens design not only offers a massive field of vision and blocks 100% of UV light, but also protects you from wind and various flying debris. Equipped with our industry-leading Light Sensitive lens technology, these sunnies have you covered in any light or weather conditions. With a construction that avoids pressure points, these shades are as comfy as they get. Grab a pair of the Vector LS and get out there!

FIT: For small to medium faces

FRAME TECHNOLOGIES:

- SCOTT Fusion Frame
- Low pressure temple tip rubber
- No-slip soft nose pads

LENS TECHNOLOGIES:

- SCOTT Light Sensitive photochromic technology
- Impact protection
- Base 7
- Maximal field of vision
- Extra large lens coverage
- ACS Air Control System
- 100% UV protection

EXTRAS

- Hard case with microfiber bag

APPROX. WEIGHT: 32g

LENS WIDTH: 68mm

LENS HEIGHT: 42mm

ARM LENGTH: 120mm

SCOTT OBSESS ACS LIGHT SENSITIVE SUNGLASSES

273340



black
grey light sensitive

The SCOTT Obsess ACS Light Sensitive Sunglasses are your best bet, offering superlative protection, secure grip and a sharp look.

FIT: For small to medium faces

FRAME TECHNOLOGIES:

- SCOTT Fusion Frame
- No-slip soft nose pads
- Textured temple pads

LENS TECHNOLOGIES:

- SCOTT Light Sensitive photochromic technology
- Impact protection
- Base 8
- ACS Air Control System
- 100% UV protection

EXTRAS

- Hard case with microfiber bag

APPROX. WEIGHT: 31g

LENS WIDTH: 59mm

LENS HEIGHT: 39mm

ARM LENGTH: 120mm



The SCOTT Obsess ACS Sunglasses are your best bet, offering superlative protection, secure grip and a sharp look.

FIT: For small to medium faces
APPROX. WEIGHT: 31g
LENS WIDTH: 59mm
LENS HEIGHT: 39mm
ARM LENGTH: 120mm

FRAME TECHNOLOGIES:

- SCOTT Fusion Frame
- No-slip soft nose pads
- Textured temple pads

LENS TECHNOLOGIES:

- Impact protection
- Base 8
- ACS Air Control System
- 100% UV protection

EXTRAS

- Hard case with microfiber bag



submariner blue
gold chrome



black/neon yellow
gold chrome

black matt
grey

soft teal green
green chrome

WHAT YOU NEED TO KNOW

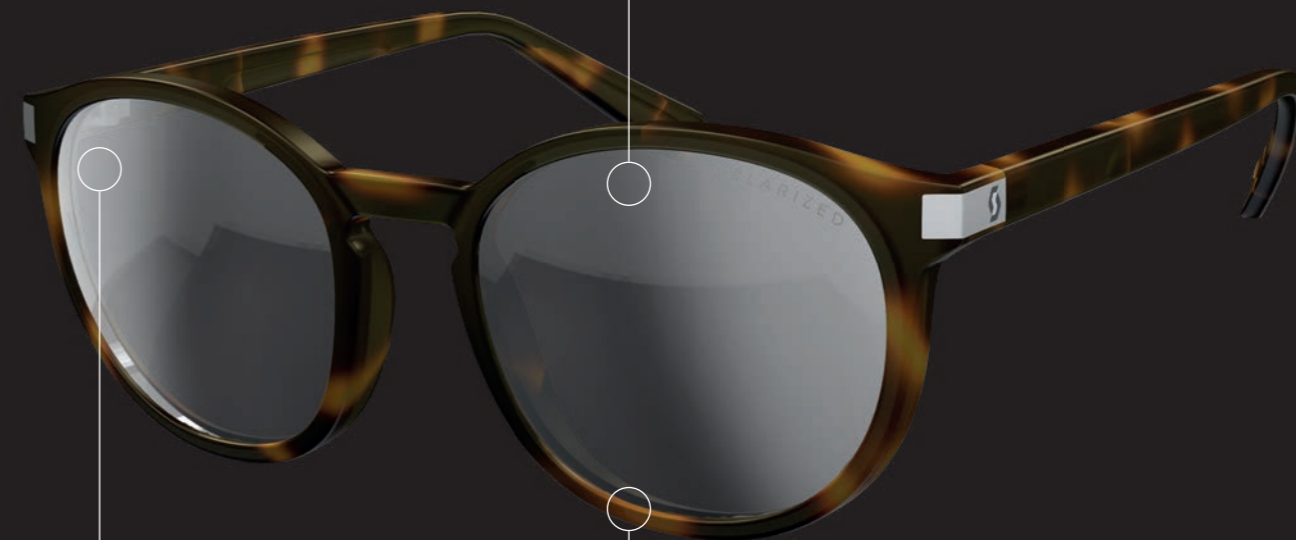

LENSES

The lenses are made from bionylon material.

POLARIZED

Polarized lenses reduce glare and reflections from surfaces like snow, glass and water and significantly improve visual comfort. Polarized lenses also increase contrast and clarity of colors.

FRAME

The frame is made from ECONYL® regenerated nylon, acquired by recycling nylon waste, such as fishing nets, fabric scraps and carpets.

DISCOVER THE LIFESTYLE COLLECTION



- RIFF -
black matt grey eco



- BASS -
black grey



- TUNE -
black matt grey

SCOTT RIFF SUNGLASSES



Modern design, outstanding quality and more eco-responsible. The frame is made from ECONYL® regenerated nylon, acquired by recycling nylon waste, such as fishing nets, fabric scraps and carpets. The lenses are made from bionylon and in addition to that the SCOTT Riff come with a recycled material pouch.



honey yellow
brown eco

FIT: For small to medium faces
FRAME TECHNOLOGIES:
• Re-source by SCOTT product
• Econyl Recycled frame material
• Hinge flex construction
• Metallic insert

APPROX. WEIGHT: 31,5g
LENS WIDTH: 52,5mm
LENS HEIGHT: 48mm
ARM LENGTH: 137mm

LENS TECHNOLOGIES:
• Base 6
• 100% UV protection
• BioNylon Ecological lens

EXTRAS
• Recycled pouch



merlot red
red chrome eco

kaki green
grey eco

tortoise red
brown eco

black matt
grey eco



LIFESTYLE
SUNGLASSES



black matt
grey eco polarized

SCOTT RIFF POLARIZED SUNGLASSES

411122



Modern design, outstanding quality and more eco-responsible. The frame is made from ECONYL® regenerated nylon, acquired by recycling nylon waste, such as fishing nets, fabric scraps and carpets. The lenses are made from bionylon and in addition to that the SCOTT Riff come with a recycled material pouch. Polarized lenses reduce glare and reflections from surfaces like snow, glass and water and significantly improve visual comfort.



kaki green
grey eco polarized

black matt
Tortoise red

FIT: For small to medium faces

APPROX. WEIGHT: 31,5g

FRAME TECHNOLOGIES:

- Re-source by SCOTT product
- Econyl Recycled frame material
- Hinge flex construction
- Metallic insert

LENS WIDTH: 52,5mm

LENS HEIGHT: 48mm

ARM LENGTH: 137mm

LENS TECHNOLOGIES:

- Base 6
- 100% UV protection
- Category 3 BioNylon Polarized lens
- Polarized print

EXTRAS

- Recycled pouch

SCOTT BASS POLARIZED SUNGLASSES

411123



The SCOTT Bass Sunglasses are made for those who want to be the center of attention, thanks to their retro style. With a Precision Optics lens offering 100% UV protection, there's no need to choose between fashion and function with these shades. Polarized lenses reduce glare and reflections from surfaces like snow, glass and water and significantly improve visual comfort.



black
grey eco polarized

FIT: For small to medium faces

APPROX. WEIGHT: 29,5g

FRAME TECHNOLOGIES:

- No-slip soft nose pads
- Leash holes on temples
- Hinge flex construction

LENS WIDTH: 59mm

LENS HEIGHT: 49mm

ARM LENGTH: 135mm

LENS TECHNOLOGIES:

- Base 6
- 100% UV protection
- Category 3 BioNylon Polarized lens
- Polarized print

EXTRAS

- Recycled pouch



kaki green
grey eco polarized

SCOTT BASS SUNGLASSES

281189



The SCOTT Bass Sunglasses are made for those who want to be the center of attention, thanks to their retro style. With a Precision Optics lens offering 100% UV protection, there's no need to choose between fashion and function with these shades.

FIT: For small to medium faces

FRAME TECHNOLOGIES:
 · No-slip soft nose pads
 · Leash holes on temples
 · Hinge flex construction

LENS TECHNOLOGIES:
 · Base 6
 · 100% UV protection

EXTRAS
 · Microfiber bag

APPROX. WEIGHT: 29,5g

LENS WIDTH: 59mm

LENS HEIGHT: 49mm

ARM LENGTH: 135mm



kaki green
brown



black
red chrome

merlot red
grey

black
grey

SCOTT TUNE SUNGLASSES



The SCOTT Tune Sunglasses perfectly blend the pinnacle of eyewear performance characteristics with a lifestyle design that will make you look stylish on any occasion. Features include a trendy and protective large lens design for supreme coverage, a flexible hinge construction, rubber temple tips with textured pads for unmatched grip during any ride and no-slip soft nose pads for all-day comfort.

FIT: For medium to large faces

FRAME TECHNOLOGIES:
 · No-slip soft nose pads
 · Textured temple pads
 · Hinge flex construction

LENS TECHNOLOGIES:
 · Base 6
 · 100% UV protection

EXTRAS
 · Microfiber bag

APPROX. WEIGHT: 28g

LENS WIDTH: 58mm

LENS HEIGHT: 46mm

ARM LENGTH: 135mm



black
blue chrome



black matt
grey

merlot red
red chrome

kaki green
grey

honey yellow
brown

SCOTT TUNE POLARIZED SUNGLASSES

411124



The SCOTT Tune Sunglasses perfectly blend the pinnacle of eyewear performance characteristics with a lifestyle design that will make you look stylish on any occasion. Features include a trendy and protective large lens design for supreme coverage, a flexible hinge construction, rubber temple tips with textured pads for unmatched grip during any ride and no-slip soft nose pads for all-day comfort. Polarized lenses reduce glare and reflections from surfaces like snow, glass and water and significantly improve visual comfort.

FIT: For medium to large faces

FRAME TECHNOLOGIES:
 · No-slip soft nose pads
 · Textured temple pads
 · Hinge flex construction

LENS TECHNOLOGIES:
 · Base 6
 · 100% UV protection
 · Category 3 BioNylon Polarized lens
 · Polarized print

EXTRAS
 · Recycled pouch

APPROX. WEIGHT: 28g

LENS WIDTH: 58mm

LENS HEIGHT: 46mm

ARM LENGTH: 135mm



black matt
grey eco polarized



kaki green
grey eco polarized

LENS TECHNOLOGIES



POLARIZED



Polarized lenses reduce glare and reflections from surfaces like snow, glass and water and significantly improve visual comfort. The lens features a filter that lets in light rays approaching vertically and blocks horizontal light waves bouncing off shiny surfaces.



Grey Eco Polarized - cat 3 - VLT 17%

ALL CONDITIONS



With changing light conditions in mind, we have put a lot of time and energy into developing what we consider to be one of the most useful aspects of any rider's kit - Light Sensitive Lenses. Depending on the intensity of UV and visible light, these lenses are formulated to change from light to dark and back in matter of seconds to provide you with the ideal level of visibility and light protection.



Grey light sensitive - cat 1-3 - VLT 10%-65%

SUN



When enjoying a very bright sunny day, you encounter strong light that contains a very intense blue light. At high intensity, this blue light can be dangerous for the eyes. In addition, due to this high intensity, the ambient brightness makes it hard to focus on other colors and therefore reduces contrast. These lenses filter out as much of the blue rays as possible while keeping the ones that help definition and clarity.



OVERCAST



We used our expertise to develop the perfect lens technology for medium-light conditions. These are ideal for partly sunny, partly cloudy days or areas partially in the shade. These lenses decrease eye fatigue by reducing the overall brightness of the environment.



Blue chrome enhancer - cat 2 - VLT 40%

Pink chrome - cat 2 - VLT 23%

LOW LIGHT



In low-light conditions, you need lenses for maximum contrast and terrain definition. This category of lenses will let through more light and make the details pop while still offering certain protection from the blue light rays.



Red chrome enhancer - cat 1 - VLT 46%

Green chrome enhancer - cat 1 - VLT 45%

NIGHT



In order to ensure that riders are safe from the impact of flying debris and protected from wind at very low light conditions, we offer clear lenses. These lenses let through the most light and are ideal for night rides.



Clear - cat 0 - VLT 92%

BACKPACKS & SAFETY



PATROL ULTRALIGHT E2 25

Pair one of the lightest fully electronic airbag system on the market - the Alpride E2 Airbag System - with state-of-the-art fabrics and you get a freeskiing backpack so light you'll almost forget you're wearing it! Designed with an extremely durable and ultralight Dyneema® fabric, this backpack is made for those adventures where weight savings and safety are a given.

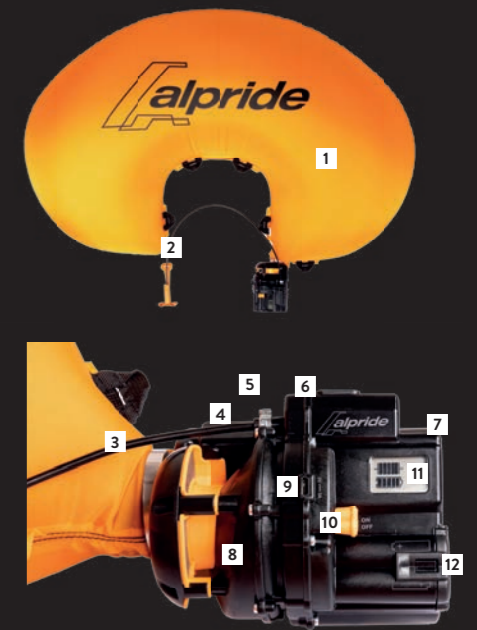

ALPRIDE E2 SYSTEM

- 1 162L airbag volume
- 2 Trigger handle
- 3 Trigger cable
- 4 Automatic pressure relief valve
- 5 Deflation knob
- 6 Status LED
- 7 Super capacitor
- 8 Turbo radial wheel compressor
- 9 USB-C port
- 10 On/off switch
- 11 LCD display
- 12 2x AA battery compartment

SCOTT PATROL ULTRALIGHT E2 25 BACKPACK



So light you'll forget you're wearing it. The Patrol Ultralight E2 25-liter freeskiing backpack is designed with an extremely durable and ultralight Dyneema® fabric. Perfect for those adventures where weight savings and safety are a given. It's airbag ready, so you can pair it up with the Alpride E2 airbag system, one of the lightest electronic airbag systems on the market to date. (E2 Airbag system not included)

TECHNOLOGIE: Dyneema®

CERTIFICATION: PPE certified Cat. II, according to EN 16716: 2017

COMPOSITION: SHELL: 73 Polyester, 27% Polyethylene, LINING: 100% Polyamide, STUFF SACK: 100% Polyester

DIMENSIONS: HEIGHT: 51cm, WIDTH: 31cm, DEPTH: 18cm

VOLUME: 25L

APPROX. WEIGHT: 780g

SIZE: NL

FEATURES:

- SCOTT Alpride Airbag System E2 ready
- Dedicated safety equipment organization pockets
- Emergency signals print
- Adjustable sternum strap with hook closure
- Adjustable hip belt with buckle closure
- Stowable safety leg loop
- Avalanche trigger pocket in left shoulder strap
- Stowable diagonal ski carry system
- Stowable helmet fixation
- Main compartment
- Inside valuables pocket
- Adjustable shoulder straps
- Stowable ice axe and pole fixations
- Gear fixation loops
- Carry handle
- Webbing keepers



white/black

SCOTT PATROL ULTRALIGHT E2 25 BACKPACK KIT

293716



Pair one of the lightest electronic airbag systems on the market – Alpride E2 airbag system – with state-of-the-art fabrics and you get a freeskiing backpack so light you'll almost forget you're wearing it. Designed with an extremely durable and ultralight Dyneema® fabric, this backpack is made for those adventures where weight savings and safety are a given.

TECHNOLOGIE: Alpride E2, Dyneema®

CERTIFICATION: PPE certified Cat. II, according to EN 16716:2017

COMPOSITION: SHELL: 73% Polyester, 27% Polyethylene, LINING: 100% Polyamide, STUFF SACK: 100% Polyester

DIMENSIONS: HEIGHT: 51cm, WIDTH: 31cm, DEPTH: 18cm

VOLUME: 25L

APPROX. WEIGHT: 780g (1920g incl. E2 system)

SIZE: NL

FEATURES:

- Exchangeable SCOTT Alpride Airbag System E2 included
- Dedicated safety equipment organization pockets
- Emergency signals print
- Adjustable sternum strap with hook closure
- Stowable safety leg loop
- Avalanche trigger pocket in left shoulder strap
- Stowable diagonal ski carry system
- Stowable helmet fixation
- Main compartment
- Inside valuables pocket
- Adjustable shoulder straps
- Stowable ice axe and pole fixations
- Gear fixation loops
- Carry handle
- Webbing keepers



white/black



MINIMALISTIC FEATURES & TECHNOLOGIES



DIAGONAL SKI CARRY SYSTEM



ICE AXE ATTACHMENT POINTS



DAISY CHAIN GEAR LOOPS



SAFETY EQUIPMENT POCKETS



STOWABLE HELMET FIXATION

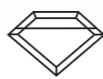

Dyneema®

EXTREMELY LIGHTWEIGHT AND DURABLE BIO-BASED FABRIC

SCOTT PATROL E2 22 BACKPACK KIT



With its 22-liter volume for sidecountry freeride days, the SCOTT Patrol E2 22 is the ultimate freeskiing avalanche backpack, evolving from the iconic SCOTT Patrol E1 22 and pushing the boundaries of innovation. It features the Alpride E2 airbag system, one of the lightest electronic on the market to date. Equipped with state-of-the-art supercapacitor technology, its new slimmer design makes it the perfect ally when every gram counts.

TECHNOLOGIE: Alpride E2, CORDURA®
CERTIFICATION: PPE certified Cat. II, according to EN 16716:2017
COMPOSITION: SHELL: 100% Polyamide, SHELL 2: 100% Polyamide, LINING: 100% Polyester, STUFF SACK: 100% Polyester
DIMENSIONS: HEIGHT: 59cm, WIDTH: 27cm, DEPTH: 19cm
VOLUME: 22L
APPROX. WEIGHT: 1380g (2520g incl. E2 system)
SIZE: SL

- FEATURES:**
- Exchangable SCOTT Alpride Airbag System E2 included
 - Dedicated safety equipment organization pockets
 - Emergency signals print
 - Adjustable sternum strap with buckle closure and integrated emergency whistle
 - Adjustable hip belt with SCOTT quick-release buckle closure
 - Stowable safety leg loop
 - Avalanche trigger pocket in left shoulder strap
 - Stowable diagonal ski carry system
 - Stowable A-frame ski and front snowboard carry and compression system
 - Stowable helmet fixation
 - Main compartment
 - Inside valuables pocket
 - Adjustable shoulder straps
 - Shoulder weight distribution system
 - Stowable ice axe and pole fixations
 - Gear fixation loops
 - Carry handle
 - Webbing keepers



light grey/black

SCOTT PATROL E2 30 BACKPACK

291184



The SCOTT Patrol E2 30 is the ultimate freeskiing avalanche backpack, evolving from our iconic SCOTT Patrol E1 30 and pushing the boundaries of innovation. Made airbag-ready so you can pair it up with the Alpride E2 airbag system, one of the lightest electronic airbag system on the market to date. (E2 Airbag system not included)

TECHNOLOGIE: CORDURA®
CERTIFICATION: PPE certified Cat. II, according to EN 16716:2017
COMPOSITION: SHELL: 100% Polyamide, SHELL 2: 100% Polyamide, LINING: 100% Polyester, STUFF SACK: 100% Polyester
DIMENSIONS: HEIGHT: 62cm, WIDTH: 29cm, DEPTH: 19cm
VOLUME: 30L
APPROX. WEIGHT: 1580g
SIZE: SL-NL
FEATURES:

- SCOTT Alpride Airbag System E2 ready
- Dedicated safety equipment compartment with organization pockets
- Emergency signals print
- Adjustable sternum strap with buckle closure and integrated emergency whistle
- Adjustable hip belt with SCOTT quick-release buckle closure
- Stowable safety leg loop
- Avalanche trigger pocket in both shoulder straps
- Stowable diagonal ski carry system
- A-frame ski and front snowboard carry and compression system
- Stowable helmet fixation
- Main compartment
- Inside valuables pocket
- Inside mesh pocket
- Adjustable shoulder straps
- Shoulder weight distribution system
- Stowable ice axe and pole fixations
- Gear fixation loops
- Carry handles
- Webbing keepers



black



light grey/black



flow blue

AVALANCHE
BACKPACKS



light grey/black

SCOTT PATROL E2 22 BACKPACK

411924



With its 22-liter volume for sidecountry freeride days, the SCOTT Patrol E2 22 is the ultimate freeskiing backpack. With freeride-specific features such as safety equipment pockets and ice axe attachment loops, this backpack will be your trusted ally when heading into the backcountry. Made airbag-ready so you can pair it up with the Alpride E2 airbag system, one of the lightest electronic airbag system on the market to date. (E2 Airbag system not included)

TECHNOLOGIE: CORDURA®
CERTIFICATION: PPE certified Cat. II, according to EN 16716:2017
COMPOSITION: SHELL: 100% Polyamide, SHELL 2: 100% Polyamide, LINING: 100% Polyester, STUFF SACK: 100% Polyester
DIMENSIONS: HEIGHT: 59cm, WIDTH: 27cm, DEPTH: 19cm
VOLUME: 22L
APPROX. WEIGHT: 1380g
SIZE: SL
FEATURES:

- SCOTT Alpride Airbag System E2 ready
- Dedicated safety equipment organization pockets
- Emergency signals print
- Adjustable sternum strap with buckle closure and integrated emergency whistle
- Adjustable hip belt with SCOTT quick-release buckle closure
- Stowable safety leg loop
- Avalanche trigger pocket in left shoulder strap
- Stowable diagonal ski carry system
- Stowable A-frame ski and front snowboard carry and compression system
- Stowable helmet fixation
- Main compartment
- Inside valuables pocket
- Adjustable shoulder straps
- Shoulder weight distribution system
- Stowable ice axe and pole fixations
- Gear fixation loops
- Carry handle
- Webbing keepers

SCOTT PATROL E2 30 BACKPACK KIT

291185



The SCOTT Patrol E2 30 is the ultimate freeskiing avalanche backpack, evolving from our iconic SCOTT Patrol E1 30 and pushing the boundaries of innovation. It features Alpride E2 airbag system, one of the lightest electronic on the market to date. Equipped with state-of-the-art supercapacitor technology, its new slimmer design makes it the perfect ally when every gram counts.

TECHNOLOGIE: Alpride E2, CORDURA®

CERTIFICATION: PPE certified Cat. II, according to EN 16716:2017

COMPOSITION: SHELL: 100% Polyamide, SHELL 2: 100% Polyamide, LINING: 100% Polyester, STUFF SACK: 100% Polyester

DIMENSIONS: HEIGHT: 62cm, WIDTH: 29cm, DEPTH: 19cm

VOLUME: 30L

APPROX. WEIGHT: 1580g (2720g incl. E2 system)

SIZE: SL-NL

FEATURES:

- Exchangable SCOTT Alpride Airbag System E2 included
- Dedicated safety equipment compartment with organization pockets

- Emergency signals print
- Adjustable sternum strap with buckle closure and integrated emergency whistle
- Adjustable hip belt with SCOTT quick-release buckle closure
- Stowable safety leg loop
- Avalanche trigger pocket in both shoulder straps
- Stowable diagonal ski carry system
- A-frame ski and front snowboard carry and compression system
- Stowable helmet fixation
- Main compartment
- Inside valuables pocket
- Inside mesh pocket
- Adjustable shoulder straps
- Shoulder weight distribution system
- Stowable ice axe and pole fixations
- Gear fixation loops
- Carry handle
- Webbing keepers



black



light grey/black



flow blue

SCOTT PATROL E2 38 BACKPACK KIT



With its 38-liter volume for big freeride days in the backcountry, the SCOTT Patrol E2 38 is the ultimate freeskiing avalanche backpack, evolving from the iconic SCOTT Patrol E1 40 and pushing the boundaries of innovation. It features the electronic Alpride E2 Airbag System, one of the lightest on the market to date. Equipped with state-of-the-art supercapacitor technology, its new slimmer design makes it the perfect ally when every gram counts.

TECHNOLOGIE: Alpride E2, CORDURA®

CERTIFICATION: PPE certified Cat. II, according to EN 16716:2017

COMPOSITION: SHELL: 100% Polyamide, SHELL 2: 100% Polyamide, LINING: 100% Polyester, STUFF SACK: 100% Polyester

DIMENSIONS: HEIGHT: 65cm, WIDTH: 32cm, DEPTH: 21cm

VOLUME: 38L

APPROX. WEIGHT: 1620g (2760g incl. E2 system)

SIZE: NL

FEATURES:

- Exchangable SCOTT Alpride Airbag System E2 included
- Dedicated safety equipment compartment with organization pockets

- Emergency signals print
- Adjustable sternum strap with buckle closure and integrated emergency whistle
- Adjustable hip belt with SCOTT quick-release buckle closure
- Stowable safety leg loop
- Avalanche trigger pocket in both shoulder straps
- Stowable diagonal ski carry system
- A-frame ski and front snowboard carry and compression system
- Stowable helmet fixation
- Main compartment
- Inside valuables pocket
- Inside mesh pocket
- Hip wing zip pocket
- Adjustable shoulder straps
- Shoulder weight distribution system
- Stowable ice axe and pole fixations
- Gear fixation loops
- Carry handle
- Webbing keepers



black



flow blue

SCOTT PATROL E2 38 BACKPACK

411926



With its 38-liter volume for big freeride days in the backcountry, the SCOTT Patrol E2 38 is the ultimate freeskiing backpack. With freeride-specific features such as safety equipment pockets and ice axe attachment loops, this backpack will be your trusted ally when heading into the backcountry. Made airbag-ready so you can pair it up with the Alpride E2 airbag system, one of the lightest electronic airbag system on the market to date. (E2 Airbag system not included)

TECHNOLOGIE: CORDURA®

CERTIFICATION: PPE certified Cat. II, according to EN 16716:2017

COMPOSITION: SHELL: 100% Polyamide, SHELL 2: 100% Polyamide, LINING: 100% Polyester, STUFF SACK: 100% Polyester

DIMENSIONS: HEIGHT: 65cm, WIDTH: 32cm, DEPTH: 21cm

VOLUME: 38L

APPROX. WEIGHT: 1620g

SIZE: NL

FEATURES:

- SCOTT Alpride Airbag System E2 ready
- Dedicated safety equipment compartment with organization pockets

- Emergency signals print
- Adjustable sternum strap with buckle closure and integrated emergency whistle
- Adjustable hip belt with SCOTT quick-release buckle closure
- Stowable safety leg loop
- Avalanche trigger pocket in both shoulder straps
- Stowable diagonal ski carry system
- A-frame ski and front snowboard carry and compression system
- Stowable helmet fixation
- Main compartment
- Inside valuables pocket
- Inside mesh pocket
- Hip wing zip pocket
- Adjustable shoulder straps
- Shoulder weight distribution system
- Stowable ice axe and pole fixations
- Gear fixation loops
- Carry handle
- Webbing keepers



black



flow blue

MOUNTAIN
BACKPACKS



light grey/black

SCOTT MOUNTAIN 35 PACK



dark grey/black



slate blue/black

The SCOTT Mountain 35 liters backpack has just the extra space you need for a longer day in the outdoors or an overnight in a hut. Despite its minimalist clean design it has all the main functions you can expect from a great pack. It features a separate front pocket with easy access for safety equipment, with easy access, a sternum strap with emergency whistle as well as a side zipper for fast access to the bag's main compartment. This bag also has a stow away ice axe/pole fixation and helmet fixation. Finally, the A-frame diagonal ski carry system or the front snowboard fixation function allows you to carry your equipment efficiently. Here we have added a comfortable hip belt with an extra pocket which allows you to have the essentials within easy reach.

COMPOSITION: SHELL: 100% Polyamide, COATING: 100% Polyurethane, SHELL 2: 100% Polyamide, LINING: 100% Polyester

DIMENSIONS: HEIGHT: 58cm, WIDTH: 28cm, DEPTH: 22cm

VOLUME: 35L

APPROX. WEIGHT: 950g

SIZE: NL

FEATURES:

- Dedicated safety equipment organization pockets
- Adjustable sternum strap with buckle closure and integrated emergency whistle
- Adjustable hip belt with buckle closure
- Rope fixation
- Stowable A-frame ski and front snowboard carry and compression system
- Winter helmet compatible
- Main compartment with fast access side zipper
- Front compartment
- Hip wing zip pocket
- Adjustable shoulder straps
- Shoulder weight distribution system
- Stowable ice axe and pole fixations
- Gear fixation loops
- Carry handle
- Webbing keepers

SCOTT MOUNTAIN 25 PACK

283677



The SCOTT Mountain 25L backpack is the go to mountain pack for your daily adventures on winter days. Despite its minimalist clean design it has all the main functions you can expect from a day pack. It features a separate front pocket with easy access for safety equipment, with easy access, a sternum strap with emergency whistle as well as a side zipper for fast access to the bag's main compartment. This bag also has a stow away ice axe/pole fixation and helmet fixation. Finally, the A-frame diagonal ski carry system or the front snowboard fixation function allows you to carry your equipment efficiently.



slate blue/black

COMPOSITION: SHELL: 100% Polyamide, SHELL 2: 100% Polyamide, COATING: 100% Polyurethane, LINING: 100% Polyester

DIMENSIONS: HEIGHT: 58cm, WIDTH: 26cm, DEPTH: 19cm

VOLUME: 25L

APPROX. WEIGHT: 670g

SIZE: SL

FEATURES:

- Dedicated safety equipment organization pockets
- Adjustable sternum strap with buckle closure and integrated emergency whistle
- Adjustable hip belt with buckle closure
- Rope fixation
- Stowable A-frame ski and front snowboard carry and compression system
- Winter helmet compatible
- Main compartment with fast access side zipper
- Front compartment
- Adjustable shoulder straps
- Shoulder weight distribution system
- Stowable ice axe and pole fixations
- Gear fixation loops
- Carry handle
- Webbing keepers

SCOTT SKI WHEEL PREMIUM BAG EVO

P278242
¥39,600 (税抜¥36,000)

このバッグはモダンなデザインかつ耐久性に優れた生地できています。そして自由に長さを調節し2組のスキー板が収納できます。それだけではなくポールなど、あなたがその日に必要とするギアが収納可能です。このバッグは防水性で複数の持ち手が付いているため持ち運びも楽な構造になっています。そしてハイクオリティーなショックアブソーバーホイールを採用しています。そしてロールアップすることによってよりコンパクトに収納ができます。

CONSTRUCTION: 1000D Polyester/900D Reverse PU	+ Functional strap for compressed storage option
COMPOSITION: 100% Polyester	+ Robust wheels to conquer all obstacles and muddy terrains
DIMENSIONS: HEIGHT: 20cm, WIDTH: 210cm, DEPTH: 30cm, PACKED: Height: 20cm, WIDTH: 23cm, DEPTH: 30cm	+ Hook-up system to attach the Ski Day Gear Bag for easier transportation
VOLUME: 2 Pairs of Skis	+ Lightweight, abrasion-resistant and water-repellent fabrics
APPROX. WEIGHT: 3.126kg	+ Movable padded separator inside to protect your skies
SIZE: one size	+ Lower and upper fixation strap inside to hold the ski in place
FEATURES	+ Different carrying versions (several handles, adjustable and padded shoulderstrap)
+ Full zip closure with roll top option to fit every ski length	



black/dark grey

SCOTT SKI SLEEVE SINGLE BAG

P267446
¥13,200 (税抜¥12,000)

よりモダンなデザインへと変更され更に耐摩耗性のある素材を使用しています。スキーを持って旅行をする際や雪のある場所へスキーを運ぶ際に最適です。結束ベルトと側面の持ち手によって運ぶ際にはもちろん積み込み際にも便利です。また最大で2mの長さのスキーを収納することが可能です。

CONSTRUCTION: 1000D Polyester/900D Reverse PU	FEATURES
COMPOSITION: 100% Polyester	+ Roll top closure fits every ski length
DIMENSIONS: HEIGHT: 20cm, WIDTH: 210cm, DEPTH: 5cm	+ Packable for minimum storage space
VOLUME: 1 Pair of Ski	+ Lightweight, abrasion-resistant and water-repellent fabrics
APPROX. WEIGHT: 700g	+ Different carrying versions (several handles, adjustable and padded shoulder strap)
SIZE: one size	



SCOTT WHEEL DUFFLE 110 BAG

P250079
¥37,400 (税抜¥34,000)

巨大なメインコンパートメントと独立したコンパートメントを備えたSCOTT Wheel Duffel 110はあらゆるギアを持ち運ぶことができます。高品質の衝撃吸収ホイールと組み合わせた耐摩耗性と撥水性に優れた布地により、世界中で活躍します。また、完全に折り畳めるため、内容物が少ないときはコンパクトにできます。バッグの剛性を保てるようなパッキングをして、ギアが地面に沿って引きずられないようにしてください。

CONSTRUCTION: 900D Reverse PU	FEATURES
COMPOSITION: SHELL FABRIC: 100% PES, LINING: 100% PES	+ Multiple carrying options (top handle, shoulder straps)
DIMENSION: HEIGHT: 85cm, WIDTH: 43cm, DEPTH: 36cm	+ Separate mud compartment
VOLUME: 110L	+ Abrasion resistant, water repellent fabric
APPROX. WEIGHT: 2660g	+ Large, solid wheels conquer obstacles and muddy terrain
SIZE: One size	+ Stuff bag for compressed storage option or as a smart place to stash muddy shoes



dark grey/red clay

SCOTT LITE DUFFLE 40 BAG

P250080
¥14,300 (税抜¥13,000)

SCOTT Lite Duffel 40は、あらゆる場面でバッグに入れられます。この軽量耐久性耐水性のあるダッフルは、快適なショルダーストラップとパッド入りハンドルを備えています。メインコンパートメントとサイドのメッシュジップポケットを装備。内側のコンパートメントを使用して快適な収納ができます。

CONSTRUCTION: H/T 420D Nylon Plain	FEATURES
COMPOSITION: SHELL FABRIC: 100% PES, LINING: 100% PES	+ Lightweight, highly water resistant duffel bag
DIMENSIONS: HEIGHT: 56cm, WIDTH: 33cm, DEPTH: 24cm	+ Multiple carrying options (top handle, shoulder straps)
VOLUME: 40L	+ Various internal mesh pockets for small items e.g. phone, wallet or passport
APPROX. WEIGHT: 630g	+ Comfortable & padded top handle
SIZE: One size	



black/red clay

SCOTT TRAVEL HARDCASE

SCOTT Travel Hardcaseは、非常に軽量でありながら耐久性が高くあらゆる旅行におけるハードな使用に耐えるように設計されています。110リットルポリウレームのハードケースは、すべてのギアを持ち込む必要がある長い旅行に最適です。特別なつや消しラバー加工表面は、最大の耐摩耗性を提供しスマートに配置されたポケットとストラップを備えた2つのコンパートメントを装備。ロックして、持ち物を安全に持ち運ぶことができます。

110 P250966
¥69,300 (税抜¥63,000)

CONSTRUCTION: ABS/Polycarbonate	FEATURES
COMPOSITION: SHELL FABRIC: 100% ABS/PC, LINING: 100% PES	+ 8 wheels
DIMENSIONS: HEIGHT: 76cm, WIDTH: 48cm, DEPTH: 30cm	+ Separate internal compartments divided by zip closure
VOLUME: 110L	+ Packing straps
APPROX. WEIGHT: 4600g	+ Inside pockets
SIZE: One size	+ TSA combination lock



110

70 P250967
¥52,800 (税抜¥48,000)

CONSTRUCTION: ABS/Polycarbonate	FEATURES
COMPOSITION: SHELL FABRIC: 100% ABS/PC, LINING: 100% PES	+ 8 wheels
DIMENSIONS: HEIGHT: 66cm, WIDTH: 41cm, DEPTH: 25cm	+ Separate internal compartments divided by zip closure
VOLUME: 70L	+ Packing straps
APPROX. WEIGHT: 3600g	+ Inside pockets
SIZE: One size	+ TSA combination lock



70

40 P250968
¥57,200 (税抜¥52,000)

CONSTRUCTION: ABS/Polycarbonate	FEATURES
COMPOSITION: SHELL FABRIC: 100% ABS/PC, LINING: 100% PES	+ 8 wheels
DIMENSIONS: HEIGHT: 56cm, WIDTH: 35cm, DEPTH: 21cm	+ Separate zipper compartment for laptop & business documents
VOLUME: 40L	+ Separate internal compartments divided by zip closure
APPROX. WEIGHT: 2600g	+ Packing straps
SIZE: One size	+ Inside pockets
	+ TSA combination lock



40

SCOTT TRAVEL SOFTCASE

SCOTT Travel Softcase は、2つのコンパートメントを備えているため、持ち物を整理しやすいです。高品質の衝撃吸収ホイールと耐久性に優れたアルミ製サイドフレームは荷物を保護するだけでなく、障害物があり、泥だらけの地形での長期旅行に最適です。

110 P275832
¥60,500 (税抜¥55,000)

CONSTRUCTION: 1000D Polyester/900D Reverse PU	FEATURES:
COMPOSITION: SHELL FABRIC: 100% Polyester, LINING: 100% Polyester	+ Inside dividers with zip pocket
DIMENSIONS: HEIGHT: 74cm, WIDTH: 48cm, DEPTH: 26cm	+ High quality shock absorbing wheels and installed heavy duty aluminum side frame
VOLUME: 110L	+ Rubberized handle grip and reinforced rib structure and wall thickness of tube
APPROX. WEIGHT: 4700g	+ Comfortable & padded top and side handle
SIZE: One size	



110

70 P250077
¥56,100 (税抜¥51,000)

CONSTRUCTION: 1000D Polyester/900D Reverse PU	FEATURES
COMPOSITION: SHELL FABRIC: 100% PES, LINING: 100% PES	+ Internal dividers and pockets
DIMENSIONS: DIMENSIONS: Height: 65cm, WIDTH: 40cm, DEPTH: 25cm	+ High quality shock absorbing wheels and installed heavy duty aluminum side frame
VOLUME: 70L	+ Rubberized handle grip, reinforced rib structure and tube wall thickness
APPROX. WEIGHT: 4200g	+ Comfortable & padded top and side handles
SIZE: One size	



70

40 P250078
¥51,700 (税抜¥47,000)

CONSTRUCTION: 1000D Polyester/900D Reverse PU	FEATURES
COMPOSITION: SHELL FABRIC: 100% PES, LINING: 100% PES	+ Internal dividers and pockets
DIMENSIONS: HEIGHT: 52cm, WIDTH: 35cm, DEPTH: 20cm	+ High quality shock absorbing wheels and installed heavy duty aluminum side frame
VOLUME: 40L	+ Outside pocket for various items e.g. phone, wallet or passport
APPROX. WEIGHT: 3200g	+ Rubberized handle grip, reinforced rib structure and tube wall thickness
SIZE: One size	+ Comfortable & padded top and side handles



40

SCOTT COMMUTER EVO 28 BACKPACK

P275833
¥28,600 (税抜¥26,000)

SCOTT Commuter Evo 28バックパックは、他には無いデザインです。メインコンパートメントへの素早く簡単なアクセスには、サイドに2方向のジッパーを備えています。またギア用のスマートな小さなポケットがたくさんあり、小物を収納できます。ラップトップとタブレット用のコンパートメントも装備。人間工学に基づいたパッド入りバックパネルは、底部に耐摩耗性があります。ビジネスシーンからトレッキング、普段使いと多用途に使えるバッグです。

- CONSTRUCTION:** 600D merlange
COMPOSITION: SHELL FABRIC: 100% Polyester, LINING: 100% Polyester
DIMENSIONS: HEIGHT: 60cm, WIDTH: 32cm, DEPTH: 21cm
VOLUME: 28L
APPROX. WEIGHT: 1740g
SIZE: One size
- FEATURES:**
+ Fixation outside for helmet & locker
+ Reflective details and Stowable hipbelt
+ Side stretch pocket for small bottles
- + Full side zipper for quick direct access into main compartment with snap bottom to fix the lower zipper puller
 - + External compartment with divider for laptop and tablet with padded and fluffy fleece lining
 - + External zip pocket for valuables with SCOTT keyholder
 - + Roll top closure system with hooks
 - + Reinforced fabric for the bottom part to protect against abrasion, dirt and water
 - + Comfortable, ergonomic padded back panel



dark grey/red clay

SCOTT MESSENGER

SCOTT Messenger バッグは、都市において多用途に使えるバッグです。2つの仕切りとラップトップコンパートメントを備え細かなアクセサリもそれぞれのポケットに収納できます。



25

dark grey/red clay

P275834
¥26,400 (税抜¥24,000)

- CONSTRUCTION:** 600D merlange
COMPOSITION: SHELL FABRIC: 100% Polyester, LINING: 100% Polyester
DIMENSIONS: HEIGHT: 38cm, WIDTH: 48cm, DEPTH: 18cm
VOLUME: 25L
APPROX. WEIGHT: 1180g
SIZE: One size
- FEATURES:**
+ Comfortable, padded air-mesh side panel
+ External laptop compartment with padded lining
+ Expandable volume
+ Stowable shoulderstraps to use the messenger
- + Big main compartment with two dividers for books, tablet, magazines, A4 papers, headphones and pens plus three stretch pockets on the front divider for valuables
 - + Additional zipper for direct access to the main compartment at the top flap
 - + Removable padded shoulder strap
 - + As a backpack
 - + Zip pocket and 2 small pockets under the main flap to store keys, cables or cards
 - + SCOOT keyholder attached with buckle inside main flap
 - + Back side sleeve to slide the bag over the handle of your luggage
 - + Comfortable & padded top handle

SCOTT TOILETRY BAG

P250083
¥7,700 (税抜¥7,000)

1日をスムーズに始めるために必要なものはすべて、このSCOTTウォッシュバッグに簡単に収まります。すべてのジッパーと弾性コンパートメントは、洗面用具の整理に役立ちます。便利な収納可能なフックにより、スペースが足りないときにバッグをどこかに掛けることができます。

- CONSTRUCTION:** 1000D Polyester/H/T 420D Nylon Plain
COMPOSITION: SHELL FABRIC: 100% PES, LINING: 100% PES
DIMENSIONS: HEIGHT: 28cm, WIDTH: 15cm, DEPTH: 10cm
VOLUME: 5L
APPROX. WEIGHT: 360g
SIZE: One size
- FEATURES**
+ Multiple internal pockets for excellent organization
+ Convenient hanging design



black/dark grey



18

dark grey/red clay

P250082
¥17,600 (税抜¥16,000)

- CONSTRUCTION:** 1000D Polyester/H/T 420D Nylon Plain
COMPOSITION: SHELL FABRIC: 100% Polyester, LINING: 100% Polyester
DIMENSIONS: HEIGHT: 42cm, WIDTH: 32cm, DEPTH: 13cm
VOLUME: 18L
APPROX. WEIGHT: 900g
SIZE: One size
- FEATURES:**
+ Comfortable, padded air-mesh side panel
+ External lock or light fixation
+ External laptop & tablet compartment with padded fluffy fleece lining
+ Inside pockets for book/A4 paper, headphones, pens
+ Highly functional external bottle holder
+ Comfortable & padded

SCOTT WALLET SMALL BAG

P250085
¥3,520 (税抜¥3,200)

スマートなSCOTTロゴ入り財布です。

- CONSTRUCTION:** 1000D Polyester/H/T 420D Nylon Plain
COMPOSITION: SHELL FABRIC: 100% PES, LINING: 100% PES
DIMENSIONS: HEIGHT: 11cm, WIDTH: 7.5cm, DEPTH: 2cm
VOLUME: one size
APPROX. WEIGHT: 50g
SIZE: One size
- FEATURES**
+ Small & smart wallet with sleeves for cards
+ Separate compartment for coins
+ Handy Hypalon puller tab for easy carrying



black/dark grey

SCOTT CASE LAPTOP

SCOTTラップトップケースは、フリースの裏地付きの柔らかな内側の層でノートパソコンをできる限り安全に持ち運ぶことができます。上部ハンドルにより、持ち運びやすく、外部コンパートメントには充電器、ケーブル、ペン、名刺などを収納できます。

CASE 17"

P250086
¥8,690 (税抜¥7,900)

- CONSTRUCTION:** 1000D Polyester/H/T 420D Nylon Plain
COMPOSITION: SHELL FABRIC: 100% PES, LINING: 100% PES
DIMENSIONS: HEIGHT: 40cm, WIDTH: 28cm, DEPTH: 4cm
VOLUME: one size
APPROX. WEIGHT: 520g
SIZE: One size
- FEATURES**
+ Comfortable & padded top handle for easy transport
+ Elastic straps for laptop fixation
+ Internal layer with padded & fluffy fleece lining
+ Space for a paper notebook & small items such as pens or business cards
+ External elastic pocket for charger & cables



CASE 17"

black/dark grey

CASE 15"

P250087
¥8,03 (税抜¥7,300)

- CONSTRUCTION:** 1000D Polyester/H/T 420D Nylon Plain
COMPOSITION: SHELL FABRIC: 100% PES, LINING: 100% PES
DIMENSIONS: HEIGHT: 35cm, WIDTH: 25cm, DEPTH: 4cm
VOLUME: one size
APPROX. WEIGHT: 440g
SIZE: One size
- FEATURES**
+ Comfortable & padded top handle for easy transport
+ Elastic straps for laptop fixation
+ Internal layer with padded & fluffy fleece lining
+ Space for a paper notebook & small items such as pens or business cards
+ External elastic pocket for charger & cables



CASE 15"

black/dark grey





THE LINE CHASER

There are no limits. By combining technicality and style, this outfit builds on the success of our previous capsule to present the brand new freeride-inspired line chaser collection. Following scott's "INNOVATION-TECHNOLOGY-DESIGN" mantra, our team implemented a new approach to the product creation process. The result? The pinnacle of technical freeride outerwear, made to explore any lines.

DESIGN

Building on the Line Chaser design lines, we have created the pinnacle of freeride outerwear. Combining technicality and style, this outerwear features all the essentials for a freeride mission: from the mid-length jacket with helmet-compatible hood for deep powder days, to its well-designed fit for optimal range of movement, whatever your riding style. The Line Chaser is your best ally when you're out searching for untouched, dream lines.

The Line Chaser collection has a modern, unisex color combo, and a range of accessories to complement your style, including our brand new high-end REACT Goggle and iconic Symbol 2 Plus D Helmet in matching light grey and sulphur yellow colorways.

TECHNOLOGY

FUNCTIONAL

The Line Chaser features fully waterproof GORE-TEX fabric for uncompromised protection in even the harshest conditions.

SUSTAINABILITY

The Line Chaser uses certified bluesign-approved GORE-TEX fabric with Solution Dyed Micro GridBacker.



OUTERWEAR
FREERIDE



metal blue/dark blue

SCOTT LINE CHASER GORE-TEX® 3 LAYER MEN'S JACKET

410975



fir green/winter green



dust white/dust grey

Designed to support athletes and freeriders on their biggest adventures, lines, drops and summits, the Line Chaser GTX 3L jacket is extremely waterproof, robust and has an articulated fit – a reliable piece when you're deep in the mountains and conditions are changeable. Technical features such as the fixed, helmet-compatible hood, pack-friendly, fully taped seams and GORE-TEX® membrane make it comfortable and give you the ultimate freedom of movement on your steepest lines.

TECHNOLOGIES: GORE-TEX®, PERFORMANCE 3L
COMPOSITION: 100% Polyester (recycled)
FIT: Regular
APPROX. WEIGHT (KG): 950g
SIZE: S-XXL

WATERPROOFNESS: 28.000 mm (ISO 811-test)
BREATHABILITY: 9 RET (ISO11092-test)
FEATURES:
• 2 chest pockets
• Hand pockets
• Sleeve pass pocket
• Underarm venting
• Attached and helmet compatible hood
• Interior knit cuffs with thumbholes
• Powder skirt
• Interior goggle pocket with detachable goggle cloth
• Security zipped interior pocket
ECO-FEATURES:
• Recycled content

SCOTT LINE CHASER GORE-TEX® 3 LAYER MEN'S PANTS



metal blue/dark blue



back



fir green/winter green



dust grey/dust white

Robust, waterproof and giving you the ultimate freedom of movement, the Line Chaser GTX 3L pants will keep you dry and protected in deep powder thanks to their high bib construction.

TECHNOLOGIES: GORE-TEX®, PERFORMANCE 3L, CORDURA®
COMPOSITION: 100% Polyester (recycled)
FIT: Regular
APPROX. WEIGHT (KG): 850g
SIZE: S-XXL

WATERPROOFNESS: 28.000 mm (ISO 811-test)
BREATHABILITY: 9 RET (ISO11092-test)
FEATURES:
• Fixed bib with integrated vest with chest pockets
• 2 zipped thigh pockets
• Zipped hem gusset
• Exterior leg venting
• CORDURA® abrasion resistant scuff panels
• Integrated snow gaiters
ECO-FEATURES:
• Recycled content

SCOTT VERTIC 3 LAYER MEN'S JACKET

283748



fir green/winter green



back



savanna green/aruba green



dust white/dust grey

Our popular freeride jacket, the SCOTT Vertic 3L (15.000mm/10.000g/m2/24h), is part of our Re-source style. If you head to the mountain only a few times per year and like to look for off piste lines, this freeride style is the best compromise you can get on performance/price.

TECHNOLOGIES: DRYOsphere 3L
COMPOSITION: 100% Polyester (recycled)
FIT: Regular
APPROX. WEIGHT (KG): 750g
SIZE: S-XXL
WATERPROOFNESS: 15.000 mm (JIS L1092 B)
BREATHABILITY: 10.000 g/m2/24hrs (JIS L 1099 B1 -inverted cup)

FEATURES:
• Chest pocket
• Hand pockets
• Sleeve pass pocket
• Underarm venting
• Attached and helmet compatible hood
• Adjustable hem & hood
• Adjustable cuffs
• Interior knit cuffs with thumbholes
• Powder skirt
• Interior goggle pocket with detachable goggle cloth
• Security zipped interior pocket

ECO-FEATURES:
• Re-source product
• Recycled content
• PFC-Free DWR

SCOTT VERTIC 3 LAYER MEN'S PANTS

407713



black



back



dark blue



aruba green



savanna green

Part of our Re-Source line, these waterproof 3-layer pants will keep you dry during those waist-deep powder days.

TECHNOLOGIES: DRYOsphere 3L, CORDURA®
COMPOSITION: 100% Polyester (recycled)
FIT: Regular
APPROX. WEIGHT (KG): 850g
SIZE: S-XXL

WATERPROOFNESS: 15.000 mm (JIS L1092 B)
BREATHABILITY: 10.000 g/m2/24hrs (JIS L 1099 B1 -inverted cup)
FEATURES:
• Flap covered thigh pocket
• Beacon-ready bib pocket incl. loop
• Exterior leg venting
• CORDURA® abrasion resistant scuff panels
• Integrated snow gaiters
ECO-FEATURES:
• Re-source product
• Recycled content
• PFC-Free DWR

SCOTT VERTIC GORE-TEX® 2 LAYER MEN'S JACKET

407632



dark blue/fir green



back



dust grey



aruba green/northern mint green

Designed for the sidecountry freeriders, this affordable GORE-TEX® jacket features a brand-new Re-Source GORE EPE membrane, making this a waterproof choice in the mountains. Made with a lightweight 2-layer construction, this jacket will be your season essential.

TECHNOLOGIES: GORE-TEX® 2L

COMPOSITION: 100% Polyester (recycled)

FIT: Regular

APPROX. WEIGHT (KG): 950g

SIZE: S-XXL

WATERPROOFNESS: 28.000 mm (ISO 811-test)

BREATHABILITY: 9 RET (ISO11092-test)

FEATURES:

- Chest pocket
- Hand pockets
- Underarm venting
- Attached and helmet compatible hood
- Adjustable hem & hood
- Adjustable cuffs
- Interior knit cuffs with thumbholes
- Powder skirt
- Interior goggle pocket with detachable goggle cloth
- Security zipped interior pocket

ECO-FEATURES:

- Re-source product
- Recycled content
- PFC-Free DWR

SCOTT VERTIC GORE-TEX® 2 LAYER MEN'S PANTS

412021



black



back



fir green/dark blue



aruba green/northern mint green

Designed for the sidecountry freeriders, these affordable GORE-TEX® pants feature a brand-new Re-Source GORE EPE membrane, making them a waterproof choice in the mountains. Made with a lightweight 2-layer construction and strategically added thermal comfort on the thighs and seat, these pants will be your season essential.

TECHNOLOGIES: GORE-TEX® 2L, CORDURA®

COMPOSITION: SHELL: 100% Polyester (recycled), LINING: 100% Polyester (recycled), LINING 2: 100% Polyester

FIT: Regular

APPROX. WEIGHT (KG): 840g

SIZE: S-XXL

WATERPROOFNESS: 28.000 mm (ISO 811-test)

BREATHABILITY: 9 RET (ISO11092-test)

FEATURES:

- 2 zipped thigh pockets
- Zipped hem gusset
- Exterior leg venting
- CORDURA® abrasion resistant scuff panels
- Integrated snow gaiters

ECO-FEATURES:

- Re-source product
- Recycled content
- PFC-Free DWR





OUTERWEAR
TOURING

metal blue/dark blue

SCOTT EXPLORAIR DRYOSPUN 3 LAYER MEN'S JACKET

410949



Made for the backcountry and exploring, the Explorair DryoSpun 3L jacket is our most breathable waterproof jacket. Using our new DryoSpun membrane, the jacket is superlight, soft and stretchy, keeping you comfortable on your multi-day tours and ascents.

TECHNOLOGIES: DRYOspun 3L
COMPOSITION: 100% Polyester (recycled)
FIT: Athletic
APPROX. WEIGHT (KG): 450g
SIZE: S-XXL

- FEATURES:**
- 2 chest pockets
 - Sleeve pass pocket
 - Underarm venting
 - Attached and helmet compatible hood
 - Adjustable hem & hood
 - Adjustable cuffs
 - Security zipped interior pocket
 - Stretch
 - Lightweight

- ECO-FEATURES:**
- Re-source product
 - Recycled content
 - PFC-Free DWR



phantom purple

aruba green/savanna green



dust grey/dust white

SCOTT EXPLORAIR DRYOSPUN 3 LAYER MEN'S PANTS



Made for the backcountry and exploring, the Explorair DryoSpun 3L pants are our most breathable waterproof pants. Using our new DryoSpun membrane, these pants are superlight, soft and stretchy, providing the ultimate freedom of movement on your multi-day tours and ascents.

TECHNOLOGIES: DRYOspun 3L
COMPOSITION: 100% Polyester (recycled)
FIT: Athletic
APPROX. WEIGHT (KG): 500g
SIZE: S-XXL

- FEATURES:**
- 2 zipped thigh pockets
 - Exterior leg venting
 - Adjustable waist with belt and hook
 - Detachable
 - Adjustable suspenders
 - CORDURA® abrasion resistant scuff panels
 - Integrated snow gaiters
 - Stretch
 - Lightweight
- ECO-FEATURES:**
- Re-source product
 - Recycled content
 - PFC-Free DWR



aruba green



back



metal blue



savanna green



dust grey

SCOTT EXPLORAIR GORE-TEX® HYBRID LIGHTWEIGHT MEN'S JACKET

410847



Designed for technical mountain activities, this jacket is made with a hybrid construction. The GORE-TEX® PERFORMANCE 3L material on the hood and shoulders can withstand the wear and tear of mountain activities, while the GORE-TEX® Paclite® fabric on the body makes the jacket lightweight and packable.

TECHNOLOGIES: GORE-TEX®, PERFORMANCE 3L, GORE-TEX® Paclite®
COMPOSITION: 100% Polyester (recycled)
FIT: Athletic
APPROX. WEIGHT (KG): 410g
SIZE: S-XXL

- WATERPROOFNESS:** 28.000 mm (ISO 811-test)
BREATHABILITY: 9 RET (ISO11092-test)
- FEATURES:**
- Hand pockets
 - Full underarm venting
 - Attached and adjustable hood
 - Adjustable hem
 - Adjustable cuffs
 - Lightweight
 - Hybrid construction
- ECO-FEATURES:**
- Recycled content



black



back



winter green/dark blue



aruba green/northern mint green



dust grey/dust white

SCOTT EXPLORAIR 3 LAYER MEN'S JACKET

408697



The SCOTT Explorair 3L jacket is one of our best-sellers and now joins our Re-Source line (15.000mm/10.000g/m2/24h). Whether you're going for an afterwork ski tour or skiing on and off piste in resort, this jacket is the ticket. It's our most versatile and affordable shell jacket.

TECHNOLOGIES: DRYOsphere 3L
COMPOSITION: 100% Polyester (recycled)
FIT: Athletic
APPROX. WEIGHT (KG): 550g
SIZE: XS-XXL
WATERPROOFNESS: 15.000 mm (JIS L1092 B)
BREATHABILITY: 10.000 g/m2/24hrs (JIS L 1099 B1 -inverted cup)

- FEATURES:**
- Hand pockets
 - Sleeve pass pocket
 - Full underarm venting
 - Attached and helmet compatible hood
 - Adjustable hem & hood
 - Adjustable cuffs
 - Security zipped interior pocket
- ECO-FEATURES:**
- Re-source product
 - Recycled content
 - PFC-Free DWR



fir green



back



dark blue/metal blue



winter green/dark blue



savanna green



dust grey/dust white



northern mint green/aruba green

SCOTT EXPLORAIR 3 LAYER MEN'S PANTS

408698

To complement our best-selling jacket, the SCOTT Explorair 3L pants are also part of our Re-Source line (20.000mm/10.000g/m²/24h). As the most affordable and most versatile pants in our shell collection, it's a double win.



black



back



dark blue aruba green fir green dust white

TECHNOLOGIES: DRYOsphere 3L
COMPOSITION: 100% Polyester (recycled)
FIT: Athletic
APPROX. WEIGHT (KG): 490g
SIZE: S-XXL
WATERPROOFNESS: 15.000 mm (JIS L1092 B)
BREATHABILITY: 10.000 g/m²/24hrs (JIS L 1099 B1 -inverted cup)

FEATURES:

- Hand pockets
- 1 zipped thigh pocket
- Exterior leg venting
- Adjustable waist
- Detachable
- Adjustable suspenders
- CORDURA® abrasion resistant scuff panels
- Integrated snow gaiters

ECO-FEATURES:

- Re-source product
- Recycled content
- PFC-Free DWR

SCOTT EXPLORAIR SOFTSHELL MEN'S PANTS



black



back



dark blue aruba green

Stretchy, durable and light, the SCOTT Explorair Softshell pants are a must-have for any and all of your mountaineering activities, throughout the seasons.

TECHNOLOGIES: DUROxpend, DRYOzone
COMPOSITION: 92% Polyamide 8% Elastane
FIT: Athletic
APPROX. WEIGHT (KG): 520g
SIZE: S-XXL

FEATURES:

- Zipped hand pockets
- Exterior leg venting
- Adjustable waist with belt and hook
- Zipped hem gusset
- Adjustable hem
- CORDURA® abrasion resistant scuff panels
- Stretch

ECO-FEATURES:

- PFC-Free DWR
- Bluesign® approved material

SCOTT EXPLORAIR SOFTSHELL PRO MEN'S PANTS

410856



dark blue/winter green



back



dust grey/dust white aruba green/northern mint green black

These technical softshell pants are made with a hybrid construction and strategically placed waterproof panels on the thighs to keep you going during wet conditions. Perfect for any winter mountain activity.

TECHNOLOGIES: DRYOsphere 3L, DUROxpend
COMPOSITION: 92% Polyamide 8% Elastane
FIT: Athletic
APPROX. WEIGHT (KG): 530g
SIZE: S-XXL

FEATURES:

- Zipped hand pockets
- 1 zipped thigh pocket
- Exterior leg venting
- Adjustable waist
- Zipped hem gusset
- CORDURA® abrasion resistant scuff panels
- Integrated snow gaiters
- Hybrid construction
- Stretch

ECO-FEATURES:

- Recycled content
- PFC-Free DWR
- Bluesign® approved material

SCOTT EXPLORAIR SOFTSHELL AIR MEN'S JACKET

412012



black



back



northern mint green winter green

This highly versatile jacket can be worn as a standalone jacket or as a layer underneath a protective shell jacket. A DWR coating, coupled with abrasion- and wind-resistant fabrics, make this jacket an essential for any high-intensity mountain activity.

TECHNOLOGIES: DUROxpend, DRYOzone
COMPOSITION: 55% Polyester (recycled) 36% Polyester 9% Elastane
FIT: Athletic
APPROX. WEIGHT (KG): 400g
SIZE: S-XXL

FEATURES:

- Zipped hand pockets
- Chest pocket with zip closure
- Elastic binding at hem
- Hood & cuffs
- Stretch

ECO-FEATURES:

- Re-source product
- Recycled content
- PFC-Free DWR

SCOTT EXPLORAIR HYBRID LIGHTWEIGHT MEN'S JACKET

291854



black



back



dark blue/metal blue winter green/dark blue dust white/dust grey northern mint green/aruba green

Engineered to be breathable and comfortable on the ascent, the SCOTT Explorair Hybrid LT jacket is stretchy and water repellent, with air-permeable material on the back for better moisture management. It was designed for fast touring skiers who enjoy high-intensity training, winter running and even hiking from time to time.

TECHNOLOGIES: DRYOsphere 3L, DUROxpend
COMPOSITION: SHELL: 100% Polyester (recycled), SHELL 2: 85% Polyamide 15% Elastane
FIT: Athletic
APPROX. WEIGHT (KG): 330g
SIZE: S-XXL

FEATURES:

- Zipped hand pockets
- Attached and adjustable hood
- Elastic binding at cuffs and hem
- Hybrid construction

ECO-FEATURES:

- Re-source product
- Recycled content
- PFC-Free DWR



OUTERWEAR
ULTIMATE



metal blue/dark blue

SCOTT ULTIMATE DERMIZAX MEN'S JACKET

291856



The Ultimate DRX is one of our bestselling insulated jackets and has now been integrated into the SCOTT Re-Source line. It's the perfect compromise of technical features at a good price for all-mountain skiers.



TECHNOLOGIES: Dermizax™ 2L
DUROloft ECO, Strategic Thermal Regulation
COMPOSITION: 100% Polyester (recycled), **FILL:** 100% Polyester (recycled)
INSULATION: 100/80g DUROloft ECO
FIT: Regular
APPROX. WEIGHT (KG): 950g
SIZE: S-XXL
WATERPROOFNESS: 20.000 mm (JIS L1092 B)
BREATHABILITY: 10.000 g/m2/24hrs (JIS L 1099 B1 -inverted cup)

- FEATURES:**
- Chest pocket
 - Zipped hand pockets under flaps
 - Sleeve pass pocket
 - Full underarm venting
 - Detachable
 - Adjustable hood
 - Adjustable cuffs
 - Adjustable hem
 - Interior goggle pocket with detachable goggle cloth
 - Security zipped interior pocket
 - Interior knit cuffs with thumbholes
 - Anti-chafe chin guard
 - Powder skirt

- ECO-FEATURES:**
- Re-source product
 - Recycled content
 - PFC-Free DWR
 - Bluesign® approved material

SCOTT ULTIMATE DERMIZAX MEN'S PANTS

277696



One of our best sellers within the SCOTT outerwear collection due to its durability and performance in any weather (rain, sleet, snow) offering excellent waterproofing (20.000mm/10.000g/m2/24h), the Ultimate DRX Pants are a winner for all mountain skiers.



dark blue



back



aruba green



fir green



metal blue



savanna green

TECHNOLOGIES: Dermizax™ 2L, DUROloft ECO
COMPOSITION: SHELL: 100% Polyester (recycled), LINING: 100% Polyester (recycled), FILL: 100% Polyester (recycled)
INSULATION: 80g DUROloft ECO
FIT: Regular
APPROX. WEIGHT (KG): 750g
SIZE: S-XXL

WATERPROOFNESS: 20.000 mm (JIS L1092 B)
BREATHABILITY: 10.000 g/m2/24hrs (JIS L 1099 B1 -inverted cup)
FEATURES:
• Zipped hand pockets
• 1 zipped thigh pocket
• Interior leg venting
• Adjustable waist
• CORDURA® abrasion resistant scuff panels
• Integrated snow gaiters
ECO-FEATURES:
• Re-source product
• Recycled content
• PFC-Free DWR
• Bluesign® approved material

SCOTT ULTIMATE DRYO PLUS MEN'S JACKET

291857



Freeride inspired, the Ultimate Dryo Plus is for all riders who like a mix of on and off piste, while always keeping the lifts within striking distance.



black



back



dark blue/metal blue



fir green/winter green

TECHNOLOGIES: DRYOsphere 2L, DUROloft, Strategic Thermal Regulation
COMPOSITION: SHELL: 100% Polyester, LINING: 100% Polyester (recycled), FILL: 100% Polyester
INSULATION: 100/80g DUROloft ECO
FIT: Regular
APPROX. WEIGHT (KG): 900g
SIZE: XS-XXL
WATERPROOFNESS: 10.000 mm (JIS L1092 B)
BREATHABILITY: 10.000 g/m2/24hrs (JIS L 1099 B1 -inverted cup)

FEATURES:
• 2 chest pockets
• Zipped hand pockets under flaps
• Sleeve pass pocket
• Full underarm venting
• Adjustable hood
• Adjustable cuffs
• Adjustable hem
• Interior goggle pocket with detachable goggle cloth
• Security zipped interior pocket
• Interior knit cuffs with thumbholes
• Anti-chafe chin guard
• Powder skirt
ECO-FEATURES:
• Recycled content
• PFC-Free DWR
• Bluesign® approved material

SCOTT ULTIMATE DRYO MEN'S JACKET

408702



The SCOTT Ultimate Dryo jacket is for versatile skiers who like to hit the resort. This jacket is waterproof, windproof and insulated, giving the performance and freeride vibes you're looking for.



back



savanna green



dark blue/winter green



aruba green/northern mint green

TECHNOLOGIES: DRYOsphere 2L, DUROloft ECO, Strategic Thermal Regulation
COMPOSITION: SHELL: 100% Polyester (recycled), LINING: 100% Polyester (recycled), FILL: 100% Polyester (recycled)
FIT: Athletic
APPROX. WEIGHT (KG): 850g
SIZE: S-XXL
WATERPROOFNESS: 15.000 mm (JIS L1092 B)
BREATHABILITY: 10.000 g/m2/24hrs (JIS L 1099 B1 -inverted cup)

FEATURES:
• Chest pocket
• Zipped hand pockets under flaps
• Sleeve pass pocket
• Full underarm venting
• Detachable
• Adjustable hood
• Adjustable cuffs
• Adjustable hem
• Interior goggle pocket with detachable goggle cloth
• Security zipped interior pocket
• Interior knit cuffs with thumbholes
• Anti-chafe chin guard
• Powder skirt
ECO-FEATURES:
• Re-source product
• Recycled content
• PFC-Free DWR
• Bluesign® approved material

SCOTT ULTIMATE DRYO 10 MEN'S JACKET



The SCOTT Ultimate Dryo 10 jacket (10.000mm/10.000g/m2 /24h) keeps you warm and dry while out on the hill and in the lift line. If you like skiing close to the lift on sunny days from first chair to last call and are looking for a good value jacket, this is it.



metal blue/dark blue



back



fir green/dark blue



phantom purple



dark blue/winter green



aruba green/savanna green



northern mint green/aruba green

TECHNOLOGIES: DRYOsphere 2L, DUROloft, Strategic Thermal Regulation
COMPOSITION: SHELL: 100% Polyester, LINING: 100% Polyester (recycled), FILL: 100% Polyester
FIT: Regular
APPROX. WEIGHT (KG): 1000g
SIZE: S-XXL
WATERPROOFNESS: 10.000 mm (JIS L1092 B)
BREATHABILITY: 10.000 g/m2/24hrs (JIS L 1099 B1 -inverted cup)

FEATURES:
• Chest pocket
• Zipped hand pockets under flaps
• Sleeve pass pocket
• Full underarm venting
• Detachable
• Adjustable hood
• Adjustable cuffs
• Adjustable hem
• Interior goggle pocket with detachable goggle cloth
• Security zipped interior pocket
• Interior knit cuffs with thumbholes
• Anti-chafe chin guard
• Powder skirt
ECO-FEATURES:
• Recycled content
• PFC-Free DWR
• Bluesign® approved material

SCOTT ULTIMATE DRYO 10 MEN'S PANTS

277701



If you are looking for comfortable and affordable pants look no further. The SCOTT Ultimate Dryo 10 pant (15.000mm/10.000g/m2 /24h) is for your days on the snow carving turns on the way down and enjoying the view from the lift on the way up.



black



back



dark blue



aruba green



fir green

TECHNOLOGIES: DRYOsphere 2L, DUROloft
COMPOSITION: 100% Polyester, FILL: 100% Polyester
INSULATION: 80g DUROloft
FIT: Athletic
APPROX. WEIGHT (KG): 850g
SIZE: S-XXL
WATERPROOFNESS: 10.000 mm (JIS L1092 B)
BREATHABILITY: 10.000 g/m2/24hrs (JIS L 1099 B1 -inverted cup)

FEATURES:
• Zipped hand pockets under flaps
• 1 zipped thigh pocket
• Interior leg venting
• Adjustable waist
• CORDURA® abrasion resistant scuff panels
• Integrated snow gaiters
ECO-FEATURES:
• Recycled content
• PFC-Free DWR
• Bluesign® approved material

**OUTERWEAR
LAYERING**



black

SCOTT EXPLORAIR ALPHA MEN'S HOODY

291798



This strategically mapped fleece, is the perfect layer for high-intensity activities like long ski-tours or intense ski days. The SCOTT Explorair Alpha hoody is the perfect piece for strategic layering all season long.



metal blue/dark blue

winter green/dark blue



aruba green/northern
mint green

TECHNOLOGIES: Polartec® Alpha® Direct, Toray Airtastic™, Grid fleece knit
COMPOSITION: SHELL: 100% Polyamide, COATING: 100% Polyurethane, SHELL 2: 94% Polyester (recycled) 6% Elastane, LINING: 100% Polyester
INSULATION: 90g Polartec Alpha Direct
FIT: Athletic
APPROX. WEIGHT (KG): 350g
SIZE: XS-XXL

FEATURES:
• 2 chest pockets
• Adjustable hem & hood
• Stretch knit cuffs
• Lightweight
• Hybrid construction
ECO-FEATURES:
• Re-source product
• Recycled content
• PFC-Free DWR

SCOTT EXPLORAIR ALPHA MEN'S VEST



The Explorair Alpha Vest is the perfect addition to your layering collection if you are the ski touring enthusiast. It is the perfect spring touring piece.



black



back



aruba green



metal blue/dark blue



phantom purple

TECHNOLOGIES: Polartec® Alpha® Direct, Toray Airtastic™, Grid fleece knit
COMPOSITION: SHELL: 100% Polyamide, COATING: 100% Polyurethane, SHELL 2: 94% Polyester (recycled) 6% Elastane, LINING: 100% Polyester
INSULATION: 90g Polartec Alpha Direct
FIT: Athletic
APPROX. WEIGHT (KG): 200g
SIZE: XS-XXL

FEATURES:
• Zipped hand pockets
• Elastic bottom hem
• Lightweight
• Hybrid construction
ECO-FEATURES:
• Re-source product
• Recycled content
• PFC-Free DWR

SCOTT EXPLORAIR ALPHA RAW MEN'S JACKET

291800



The Explorair Alpha Raw is a mix of technical and cosy, simple and efficient. Highly breathable, lightweight and warm it is a layer you will never leave at home during the winter season or on expeditions.



black



back



metal blue/dark blue

TECHNOLOGIES: Polartec® Alpha® Direct, Grid fleece knit
COMPOSITION: SHELL: 94% Polyester (recycled) 6% Elastane, SHELL 2: 100% Polyester
FIT: Athletic
APPROX. WEIGHT (KG): 210g
SIZE: XS-XXL

FEATURES:
• Chest pocket
• Lightweight
• Hybrid construction
ECO-FEATURES:
• Re-source product
• Recycled content
• PFC-Free DWR

SCOTT INSULOFT STRETCH MEN'S JACKET

408061



black



back



dark blue



northern mint green



fir green



savanna green

A fully stretchable insulator with a clean, minimalist design. One of our warmest insulators, it features a seamless baffle construction to keep the heat in, and the cold out.

TECHNOLOGIES: DUROloft ECO, DUROxpannd
COMPOSITION: SHELL: 86% Polyamide 14% Elastane, FILL: 100% Polyester (recycled)
INSULATION: DUROloft ECO insulation
FIT: Athletic
APPROX. WEIGHT (KG): 480g
SIZE: S-XXL

FEATURES:
 • Zipped hand pockets
 • Seamless baffle construction
 • Elastic bottom hem and cuffs
 • Stretch
ECO-FEATURES:
 • Recycled content
 • PFC-Free DWR

SCOTT INSULOFT LIGHT MEN'S HOODY

291805



black



back



aruba green



fir green



metal blue/dark blue

The Insuloft Light hoody is our most versatile insulator. Part of our Re-Source line, it features a clean design and enhanced freedom of movement. It's a foundational piece for any year-round outdoor enthusiasts.

TECHNOLOGIES: DUROloft ECO, Toray Airtastic™, Brushed fleece knit
COMPOSITION: SHELL: 100% Polyamide, COATING: 100% Polyurethane, SHELL 2: 63% Polyester (recycled) 37% Polyester, LINING: 100% Polyester (recycled), PADDING: 100% Polyester (recycled)
INSULATION: 60g DUROloft ECO
FIT: Athletic
APPROX. WEIGHT (KG): 360g
SIZE: S-XXL

FEATURES:
 • Packable
 • Zipped hand pockets
 • Chest pocket
 • Adjustable hem & hood
 • Stretch knit cuffs
 • Stretch underarm & side panels
 • Lightweight
ECO-FEATURES:
 • Re-source product
 • Recycled content
 • PFC-Free DWR

SCOTT INSULOFT TECH PRIMALOFT MEN'S HOODY



black



back



metal blue



savanna green



dust white

Feels like down, looks like down. The Tech Primaloft line of insulators features an ultralight 15D outer fabric and Primaloft ThermoPlume insulation, making it our warmest, lightest and most packable insulator in the line.

TECHNOLOGIES: Primaloft® ThermoPlume®
COMPOSITION: 100% Polyamide, FILL: 100% Polyester (recycled)
FIT: Athletic
APPROX. WEIGHT (KG): 450g
SIZE: S-XXL

FEATURES:
 • Packable
 • Zipped hand pockets
 • Adjustable hood
 • Elastic binding at hem
 • Hood & cuffs
 • Lightweight
ECO-FEATURES:
 • Recycled content
 • PFC-Free DWR

SCOTT INSULOFT TECH PRIMALOFT MEN'S JACKET

408708



aruba green



back



fir green



savanna green



winter green

Feels like down, looks like down. The Tech Primaloft line of insulators features an ultralight 15D outer fabric and Primaloft ThermoPlume insulation, making it our warmest, lightest and most packable insulator in the line.

TECHNOLOGIES: Primaloft® ThermoPlume®
COMPOSITION: 100% Polyamide, FILL: 100% Polyester (recycled)
FIT: Athletic
APPROX. WEIGHT (KG): 420g
SIZE: S-XXL

FEATURES:
 • Zipped hand pockets
 • Adjustable hem & hood
 • Packable
 • Lightweight
ECO-FEATURES:
 • Recycled content
 • PFC-Free DWR

SCOTT INSULOFT TECH MEN'S SHORTS

408960



black



back

Feels like down, looks like down. The Insuloft Tech shorts are designed with an ultralight 15D outer fabric and DUROloft insulation, giving them an excellent warmth-to-weight ratio.

TECHNOLOGIES: DUROloft ECO
COMPOSITION: SHELL: 100% Polyamide, SHELL 2: 70% Polyester (recycled) 30% Polyester, LINING: 100% Polyester (recycled), FILL: 100% Polyester (recycled)
FIT: Athletic
APPROX. WEIGHT (KG): 400g
SIZE: S-XXL

FEATURES:
 • 1 zipped pocket
 • Packable
 • Lightweight
ECO-FEATURES:
 • Recycled content
 • PFC-Free DWR

SCOTT DEFINED WARM HYBRID MEN'S HOODY

411101



The warmest fleece of the line combines the best of both worlds: windproof and insulated in the front, with soft fleece on the sleeves and back. Stretchable, warm, and breathable, this piece is a must-have on the slopes.



black



back



fir green



savanna green

TECHNOLOGIES: DUROloft ECO
COMPOSITION: SHELL: 91% Polyester (recycled) 9% Lyocell, SHELL 2: 86% Polyamide 14% Elastane, FILL: 100% Polyester (recycled)
INSULATION: DUROloft ECO insulation
FIT: Regular
APPROX. WEIGHT (KG): 460g
SIZE: S-XXL

FEATURES:
• Zipped hand pockets
• Elastic bottom hem and cuffs
• Seamless baffle construction
• Hybrid construction
ECO-FEATURES:
• Re-source product
• Recycled content
• PFC-Free DWR

SCOTT DEFINED HERITAGE PILE MEN'S JACKET

411126



The Defined Heritage pile fleece jacket gives you that retro look. Featuring a warm pile fleece knitted fabric, this is definitely an everyday essential.



black



back



fir green



dust white

TECHNOLOGIES: Pile fleece knit
COMPOSITION: 100% Polyester
FIT: Regular
APPROX. WEIGHT (KG): 570g
SIZE: S-XXL

FEATURES:
• Zipped hand pockets
• Chest pocket
• Elastic bottom hem and cuffs
ECO-FEATURES:
• Recycled content
• PFC-Free DWR

SCOTT DEFINED OPTIC MEN'S JACKET

27764



The SCOTT Defined Optic Jacket sports a classic sweater look, while using the highest quality fabrics SCOTT is known for, ensuring that you stay warm and stylish whether it is at the resort or out in town.



black/black



back



dark blue/black



dust white

TECHNOLOGIES: Sweater knit
COMPOSITION: 100% Polyester
FIT: Athletic
APPROX. WEIGHT (KG): 500g
SIZE: S-XXL

FEATURES:
• Zipped hand pockets
• Reinforcement at hand pockets
• Reinforcement at shoulders
ECO-FEATURES:
• PFC-Free DWR

SCOTT DEFINED ORIGINAL FLEECE MEN'S PULLOVER



The defined original fleece is one of our versatile winter layer. Warm and inspired by the 90s, you can wear it in the resort as a sporty casual look as well as with jeans and nice sneakers in the city for a more retro style.



aruba green/savanna green



back

TECHNOLOGIES: Pile fleece knit
COMPOSITION: 100% Polyester (recycled)
FIT: Athletic
APPROX. WEIGHT (KG): 430g
SIZE: S-XXL

FEATURES:
• Zipped hand pockets
• Half zip
• Elastic binding at hem
• Hood & cuffs
ECO-FEATURES:
• Re-source product
• Recycled content

SCOTT DEFINED TECH MEN'S HOODY

410988



The Defined Tech is a staple of every outdoor enthusiast's closet. Designed with freedom of movement, breathability and moisture management in mind, it is the one layer that every versatile skier needs.



black



back



dark blue



savanna green

TECHNOLOGIES: Grid fleece knit
COMPOSITION: 94% Polyester (recycled) 6% Elastane
FIT: Athletic
APPROX. WEIGHT (KG): 350g
SIZE: S-XXL

FEATURES:
• Zipped hand pockets
• Elastic binding at hood
• Stretch
ECO-FEATURES:
• Re-source product
• Recycled content
• Bluesign® approved material

SCOTT DEFINED TECH MEN'S JACKET

411127



The Defined Tech is a staple of every outdoor enthusiast's closet. Designed with freedom of movement, breathability and moisture management in mind, it is the one layer that every versatile skier needs.



black



back



dark blue



northern mint green



winter green/dark blue

TECHNOLOGIES: Grid fleece knit
COMPOSITION: 94% Polyester (recycled) 6% Elastane
FIT: Athletic
APPROX. WEIGHT (KG): 325g
SIZE: S-XXL

FEATURES:
• Chest pockets
• Stretch
ECO-FEATURES:
• Re-source product
• Recycled content
• Bluesign® approved material

SCOTT DEFINED MID MEN'S HOODY

291812



black



back



light grey



metal blue/dark blue



dark blue/fir green



northern mint green/aruba green

The Defined Mid hoody is a lifestyle yet technical hoody. Sporty, it is the kind of layer you will use for any activity in the resorts.

TECHNOLOGIES: Brushed fleece knit
COMPOSITION: 63% Polyester (recycled)
37% Polyester
FIT: Athletic
APPROX. WEIGHT (KG): 350g
SIZE: XS-XXL

FEATURES:
• Zipped hand pockets
• Stretch
ECO-FEATURES:
• Re-source product
• Recycled content

SCOTT DEFINED MID MEN'S PULLOVER HOODY

294674



black



back



dark blue



light grey



aruba green



fir green



dust white

The Defined Mid hoody is a lifestyle yet technical hoody. Sporty, it is the kind of layer you will use for any activity in the resorts.

TECHNOLOGIES: Brushed fleece knit
COMPOSITION: 63% Polyester (recycled)
37% Polyester
FIT: Athletic
APPROX. WEIGHT (KG): 350g
SIZE: XS-XXL

FEATURES:
• Zipped hand pockets
• Adjustable hood
• Stretch
ECO-FEATURES:
• Re-source product
• Recycled content

SCOTT DEFINED LIGHT MEN'S PULLOVER

291813



black



back



dark blue



metal blue/dark blue



winter green



savanna green/aruba green



aruba green/northern mint green

A polyester blend with a delightful soft-brushed back, the SCOTT Defined Light Pullover is a great transitional piece that can be worn next to the skin or as a mid-layer.

TECHNOLOGIES: Grid fleece knit
COMPOSITION: 94% Polyester (recycled)
6% Elastane
FIT: Athletic
APPROX. WEIGHT (KG): 200g
SIZE: XS-XXL

FEATURES:
• Quarter zip
• Highly breathable
• Stretch
• Lightweight
ECO-FEATURES:
• Re-source product
• Recycled content

SCOTT DEFINED MERINO LONG-SLEEVE MEN'S HOODY



dark blue/light grey melange



back



aruba green

SCOTT Merino base layers are naturally performing for all your outdoor activities. The thermal regulation and high breathability work as a second skin, performing in winter or summer and backing you up from first lift to last call. Excellent moisture management, enhanced the odor management and a soft feel. With the new hood, it adds a feeling of comfort and additional protection for your expeditions.

TECHNOLOGIES: Merino Wool
COMPOSITION: 100% Wool (merino)
FIT: Slim
APPROX. WEIGHT (KG): 260g
SIZE: S-XXL

FEATURES:
• Elastic binding at hood
• Seasonal graphic print
ECO-FEATURES:
• Re-source product
• Recycled content
• Mulesing-free Merino Wool

SCOTT DEFINED MERINO LONG-SLEEVE MEN'S SHIRT

277772



dark blue/light grey melange



back



aruba green

SCOTT Merino base layers are naturally performing for all your outdoor activities. The thermal regulation and high breathability work as a second skin, performing in winter or summer and backing you up from first lift to last call. Excellent moisture management, enhanced the odor management and a soft feel.

TECHNOLOGIES: Merino Wool
COMPOSITION: 100% Wool (merino)
FIT: Slim
APPROX. WEIGHT (KG): 220g
SIZE: S-XXL

FEATURES:
• Seasonal graphic print
ECO-FEATURES:
• Re-source product
• Recycled content
• Mulesing-free Merino Wool

SCOTT DEFINED MERINO MEN'S PANTS

277773



dark blue



back



aruba green

SCOTT Merino base layers are naturally performing for all your outdoor activities. The thermal regulation and high breathability work as a second skin, performing in winter or summer and backing you up from first lift to last call. Excellent moisture management, enhanced the odor management and a soft feel.

TECHNOLOGIES: Merino Wool
COMPOSITION: 100% Wool (merino)
FIT: Slim
APPROX. WEIGHT (KG): 180g
SIZE: S-XXL

FEATURES:
• Elastic waistband
ECO-FEATURES:
• Re-source product
• Recycled content
• Mulesing-free Merino Wool



OUTERWEAR
FREERIDE



dust white/dust grey
(410973)



SCOTT LINE CHASER GORE-TEX® 3 LAYER WOMEN'S JACKET

410973
291858



Crafted to support athletes and freeriders on their biggest adventures, lines, drops or summits, the Line Chaser GTX 3L jacket is extremely waterproof, robust and with an articulated fit - a reliable piece when you're deep in the mountains and conditions are changeable. Technical features such as the fixed, helmet-compatible hood, pack-friendly fully taped seams and GORE-TEX® membrane make it comfortable and give you the ultimate freedom of movement on your steepest line.

TECHNOLOGIES: GORE-TEX®, PERFORMANCE 3L

COMPOSITION: 100% Polyamide (recycled)

FIT: Regular

APPROX. WEIGHT (KG): 800g

SIZE: EU XS-EU XL

WATERPROOFNESS: 28.000 mm (ISO 811-test)

BREATHABILITY: 9 RET (ISO11092-test)

FEATURES:

- 2 chest pockets
- Hand pockets
- Sleeve pass pocket
- Underarm venting
- Attached and helmet compatible hood
- Interior knit cuffs with thumbholes
- Powder skirt
- Interior goggle pocket with detachable goggle cloth
- Security zipped interior pocket

ECO-FEATURES:

- Recycled content

SCOTT LINE CHASER GORE-TEX® 3 LAYER WOMEN'S PANTS



dust grey/dust white (410972)



back

Robust, waterproof and giving you the ultimate freedom of movement, the Line Chaser GTX 3L pants will keep you dry and protected in deep powder thanks to their high bib construction.

TECHNOLOGIES: GORE-TEX®, PERFORMANCE 3L, CORDURA®

COMPOSITION: 100% Polyester (recycled)

FIT: Regular

APPROX. WEIGHT (KG): 900g

SIZE: EU XS-EU XL

WATERPROOFNESS: 28.000 mm (ISO 811-test)

BREATHABILITY: 9 RET (ISO11092-test)

FEATURES:

- High waist bib with stretchable side & back panels & adjustable suspenders
- Beacon-ready bib pocket incl. loop
- 2 zipped thigh pockets
- Zipped hem gusset
- Exterior leg venting
- CORDURA® abrasion resistant scuff panels
- Integrated snow gaiters

ECO-FEATURES:

- Recycled content

SCOTT VERTIC 3 LAYER WOMEN'S JACKET

291860



heather purple



back



cloud pink/fir green



dust white/dust grey

With its freeride look, the SCOTT Vertic 3L jacket is for big-mountain skiers looking for deep powder fields. Durable and protective, this jacket doesn't compromise on style or performance.

TECHNOLOGIES: DRYOsphere 3L

COMPOSITION: 100% Polyester (recycled)

FIT: Regular

APPROX. WEIGHT (KG): 700g

SIZE: EU XS-EU XL

WATERPROOFNESS: 15.000 mm (JIS L1092 B)

BREATHABILITY: 10.000 g/m2/24hrs (JIS L 1099 B1 -inverted cup)

FEATURES:

- Chest pocket
- Hand pockets
- Sleeve pass pocket
- Underarm venting
- Attached and helmet compatible hood
- Adjustable hem & hood
- Adjustable cuffs
- Interior knit cuffs with thumbholes
- Powder skirt
- Interior goggle pocket with detachable goggle cloth
- Security zipped interior pocket

ECO-FEATURES:

- Re-source product
- Recycled content
- PFC-Free DWR

SCOTT VERTIC 3 LAYER WOMEN'S PANT

283761



fir green



back



dust white

As the Jacket, the Vertic 3L Pants have been integrated into our Re-Source line. The regular fit construction ensures you stay dry on those Champagne powder days. (15.000mm/10.000g/m2/24h)

TECHNOLOGIES: DRYOsphere 3L, CORDURA®

COMPOSITION: 100% Polyester (recycled)

FIT: Regular

APPROX. WEIGHT (KG): 720g

SIZE: EU XS-EU XL

WATERPROOFNESS: 15.000 mm (JIS L1092 B)

BREATHABILITY: 10.000 g/m2/24hrs (JIS L 1099 B1 -inverted cup)

FEATURES:

- Hand pockets
- Beacon-ready bib pocket incl. loop
- Exterior leg venting
- CORDURA® abrasion resistant scuff panels
- Integrated snow gaiters

ECO-FEATURES:

- Re-source product
- Recycled content
- PFC-Free DWR

SCOTT VERTIC GORE-TEX® 2 LAYER WOMEN'S JACKET

411125



Designed for the sidecountry freeriders, this affordable GORE-TEX® jacket features a brand new Re-Source GORE EPE membrane, making this a waterproof choice on the mountains. Made with a lightweight 2-layer construction this jacket will be your season essential.



dust white



back



cloud pink/fir green



northern mint green/aruba green

TECHNOLOGIES: GORE-TEX® 2L
COMPOSITION: 100% Polyester (recycled)
FIT: Athletic
APPROX. WEIGHT (KG): 900g
SIZE: EU XS-EU XL

WATERPROOFNESS: 28.000 mm (ISO 811-test)
BREATHABILITY: 9 RET (ISO11092-test)
FEATURES:
• Chest pocket
• Hand pockets
• Underarm venting
• Attached and helmet compatible hood
• Adjustable hem & hood
• Adjustable cuffs
• Interior knit cuffs with thumbholes
• Powder skirt
• Interior goggle pocket with detachable goggle cloth
• Security zipped interior pocket
ECO-FEATURES:
• Re-source product
• Recycled content
• PFC-Free DWR

SCOTT EXPLORAIR 3 LAYER WOMEN'S PANTS



To complement our best-selling jacket, the SCOTT Explorair 3L pants are also part of our Re-Source line (15.000mm/10.000g/m2/24h. As the most affordable and most versatile pants in our shell collection, it's a double win.



black



back



aruba green



fir green



dust white



cloud pink



wild red

TECHNOLOGIES: DRYOsphere 3L
COMPOSITION: 100% Polyester (recycled)
FIT: Athletic
APPROX. WEIGHT (KG): 430g
SIZE: EU XS-EU XL
WATERPROOFNESS: 15.000 mm (JIS L1092 B)
BREATHABILITY: 10.000 g/m2/24hrs (JIS L 1099 B1 -inverted cup)

FEATURES:
• Hand pockets
• 1 zipped thigh pocket
• Exterior leg venting
• Adjustable waist
• Detachable
• Adjustable suspenders
• CORDURA® abrasion Resistant scuff panels
• Integrated snow gaiters
ECO-FEATURES:
• Re-source product
• Recycled content
• PFC-Free DWR

SCOTT VERTIC GORE-TEX® 2 LAYER WOMEN'S PANTS

412022



Designed for the sidecountry freeriders, these affordable GORE-TEX® pants feature a brand-new Re-Source GORE EPE membrane, making them a waterproof choice in the mountains. Made with a lightweight 2-layer construction and strategically added thermal comfort on the thighs and seat, these pants will be your season essential.



black



back



fir green



aruba green/northern mint green

TECHNOLOGIES: GORE-TEX® 2L, CORDURA®
COMPOSITION: SHELL: 100% Polyester (recycled), LINING: 100% Polyester (recycled), LINING 2: 100% Polyester
FIT: Regular
APPROX. WEIGHT (KG): 840g
SIZE: EU XS-EU XL

WATERPROOFNESS: 28.000 mm (ISO 811-test)
BREATHABILITY: 9 RET (ISO11092-test)
FEATURES:
• 2 zipped thigh pockets
• Zipped hem gusset
• Exterior leg venting
• CORDURA® abrasion resistant scuff panels
• Integrated snow gaiters
ECO-FEATURES:
• Re-source product
• Recycled content
• PFC-Free DWR

SCOTT EXPLORAIR HYBRID LT WOMEN'S JACKET

291866



Engineered to be breathable and comfortable on the ascent, the SCOTT Explorair Hybrid LT jacket is stretchy and water repellent, with air-permeable material on the back for better moisture management. It was designed for fast touring skiers who enjoy high-intensity training, winter running and even hiking from time to time.



dust white/dust grey



northern mint green/aruba green

TECHNOLOGIES: DRYOsphere 3L, DUROxpan
COMPOSITION: SHELL: 100% Polyester (recycled), SHELL 2: 85% Polyamide 15% Elastane
FIT: Athletic
APPROX. WEIGHT (KG): 310g
SIZE: EU XS-EU XL

FEATURES:
• Zipped hand pockets
• Attached and adjustable hood
• Elastic binding at cuffs and hem
• Hybrid construction
ECO-FEATURES:
• Re-source product
• Recycled content
• PFC-Free DWR

SCOTT EXPLORAIR 3 LAYER WOMEN'S JACKET

408704



The SCOTT Explorair 3L jacket is one of our best-sellers and now joins our Re-Source line (15.000mm/10.000g/m2/24h). Whether you're going for an afterwork ski tour or skiing on and off piste in resort, this jacket is the ticket. It's our most versatile and affordable shell jacket.



fir green



back



dark blue/metal blue



heather purple



cloud pink/wild red



northern mint green/aruba green

TECHNOLOGIES: DRYOsphere 3L
COMPOSITION: 100% Polyester (recycled)
FIT: Athletic
APPROX. WEIGHT (KG): 470g
SIZE: EU XS-EU XXL
WATERPROOFNESS: 15.000 mm (JIS L1092 B)
BREATHABILITY: 10.000 g/m2/24hrs (JIS L 1099 B1 -inverted cup)

FEATURES:
• Hand pockets
• Sleeve pass pocket
• Full underarm venting
• Attached and helmet compatible hood
• Adjustable hem & hood
• Adjustable cuffs
• Security zipped interior pocket
ECO-FEATURES:
• Re-source product
• Recycled content
• PFC-Free DWR

SCOTT EXPLORAIR SOFTSHELL AIR WOMEN'S JACKET

412014



This highly versatile jacket can be worn as a standalone jacket or as a layer underneath a protective shell jacket. A DWR coating, coupled with abrasion- and wind-resistant fabrics, make this jacket an essential for any high-intensity mountain activity.



black



back



northern mint green



cloud pink

TECHNOLOGIES: DUROxpan, DRYOzone
COMPOSITION: 55% Polyester (recycled) 36% Polyester 9% Elastane
FIT: Athletic
APPROX. WEIGHT (KG): 370g
SIZE: EU XS-EU XL

FEATURES:
• Zipped hand pockets
• Chest pocket with zip closure
• Elastic binding at hem
• Hood & cuffs
• Stretch
ECO-FEATURES:
• Re-source product
• Recycled content
• PFC-Free DWR



OUTERWEAR
ULTIMATE



black



SCOTT ULTIMATE DRYO PLUS WOMEN'S JACKET

291870



Freeride inspired, the Ultimate Dryo Plus is for all riders who like a mix of on and off piste, while always keeping the lifts within striking distance.

TECHNOLOGIES: DRYOsphere 2L, DUROloft, Strategic Thermal Regulation

COMPOSITION: 100% Polyester, **FILL:** 100% Polyester

FIT: Regular

APPROX. WEIGHT (KG): 800g

SIZE: EU XS-EU XXL

WATERPROOFNESS: 10.000 mm (JIS L1092 B)

BREATHABILITY: 10.000 g/m2/24hrs (JIS L 1099 B1 -inverted cup)

FEATURES:

- Zipped hand pockets under flaps
- Sleeve pass pocket
- Full underarm venting
- Adjustable hood
- Adjustable cuffs
- Adjustable hem
- Interior goggle pocket with detachable goggle cloth
- Security zipped interior pocket
- Interior knit cuffs with thumbholes
- Anti-chafe chin guard
- Powder skirt

ECO-FEATURES:

- Recycled content
- PFC-Free DWR
- Bluesign® approved material



heather purple



cloud pink/wild red



aruba green/northern mint green

SCOTT ULTIMATE DERMIZAX WOMEN'S PANT



One of our best sellers within the SCOTT outerwear collection due to its durability and performance in any weather-rain, sleet, snow. The pant offers excellent waterproofing (20.000mm/10.000g/m2/24h).



black



back



aruba green



fir green



heather purple

TECHNOLOGIES: Dermizax™ 2L, DUROloft ECO

COMPOSITION: SHELL: 100% Polyester (recycled), LINING: 100% Polyester, FILL: 100% Polyester (recycled)

INSULATION: 80g DUROloft ECO

FIT: Slim

APPROX. WEIGHT (KG): 650g

SIZE: EU XS-EU XL

WATERPROOFNESS: 20.000 mm (JIS L1092 B)

BREATHABILITY: 10.000 g/m2/24hrs (JIS L 1099 B1 -inverted cup)

FEATURES:

- Zipped hand pockets
- Interior leg venting
- Adjustable waist
- CORDURA® abrasion resistant scuff panels
- Integrated snow gaiters

ECO-FEATURES:

- Re-source product
- Recycled content
- PFC-Free DWR
- Bluesign® approved material

SCOTT ULTIMATE WARM WOMEN'S JACKET

291869



The Ultimate Warm jacket is part of our on-piste ski collection, offering extra insulation that keeps the cold out whether you are working hard or taking things easy.



dark blue



back



northern mint green



dust white

TECHNOLOGIES: DRYOsphere 2L, DUROloft ECO

COMPOSITION: 100% Polyester, **FILL:** 100% Polyester (recycled)

INSULATION: DUROloft ECO insulation

FIT: Athletic

APPROX. WEIGHT (KG): 1700g

SIZE: EU XS-EU XXL

WATERPROOFNESS: 10.000 mm (JIS L1092 B)

BREATHABILITY: 10.000 g/m2/24hrs (JIS L 1099 B1 -inverted cup)

FEATURES:

- Zipped hand pockets under flaps
- Chest pocket
- Sleeve pass pocket
- Full underarm venting
- Detachable
- Adjustable hood
- Adjustable cuffs
- Interior goggle pocket with detachable goggle cloth
- Security zipped interior pocket
- Interior knit cuffs with thumbholes
- Anti-chafe chin guard
- Powder skirt

ECO-FEATURES:

- Re-source product
- Recycled content
- PFC-Free DWR
- Bluesign® approved material

SCOTT ULTIMATE DRYO WOMEN'S JACKET

408703



The SCOTT Ultimate Dryo jacket is for versatile skiers who like to hit the resort. This jacket is waterproof, windproof and insulated, giving the performance and freeride vibes you're looking for.



heather purple



back



wild red



northern mint green/aruba green

TECHNOLOGIES: DRYOsphere 2L, DUROloft ECO, Strategic Thermal Regulation
COMPOSITION: SHELL: 100% Polyester (recycled), LINING: 100% Polyester (recycled), FILL: 100% Polyester (recycled)
FIT: Athletic
APPROX. WEIGHT (KG): 650g
SIZE: EU XS-EU XL
WATERPROOFNESS: 15.000 mm (JIS L1092 B)
BREATHABILITY: 10.000 g/m²/24hrs (JIS L 1099 B1 -inverted cup)

FEATURES:

- Chest pocket
- Zipped hand pockets
- Sleeve pass pocket
- Full underarm venting
- Detachable
- Adjustable hood
- Adjustable cuffs
- Adjustable hem
- Interior goggle pocket with detachable goggle cloth
- Security zipped interior pocket
- Interior knit cuffs with thumbholes
- Anti-chafe chin guard
- Powder skirt

ECO-FEATURES:

- Re-source product
- Recycled content
- PFC-Free DWR
- Bluesign® approved material

SCOTT ULTIMATE DRYO 10 WOMEN'S JACKET

418826



The SCOTT Ultimate Dryo 10 jacket will keep you warm and dry while out on the hill and in the lift line. If you like skiing in resort on sunny days from first lift to last, and are looking for a good-value jacket, this is the one.



dark blue/metal blue



back



wild red/cloud pink



aruba green/northern mint green

TECHNOLOGIES: DRYOsphere 2L, DUROloft, Strategic Thermal Regulation
COMPOSITION: SHELL: 100% Polyester, LINING: 100% Polyester, LINING 2: 100% Polyester (recycled), FILL: 100% Polyester
INSULATION: 100/80g DUROloft
FIT: Regular
APPROX. WEIGHT (KG): 800g
SIZE: EU XS-EU XXL
WATERPROOFNESS: 10.000 mm (JIS L1092 B)

BREATHABILITY: 10.000 g/m²/24hrs (JIS L 1099 B1 -inverted cup)

FEATURES:

- Chest pocket
- Zipped hand pockets under flaps
- Sleeve pass pocket
- Full underarm venting
- Detachable
- Adjustable hood
- Adjustable cuffs
- Adjustable hem
- Interior goggle pocket with detachable goggle cloth
- Security zipped interior pocket
- Interior knit cuffs with thumbholes
- Anti-chafe chin guard
- Powder skirt

ECO-FEATURES:

- Recycled content
- PFC-Free DWR
- Bluesign® approved material

SCOTT ULTIMATE DRYO 10 WOMEN'S PANT

277723



The SCOTT Ultimate Dryo 10 Pant (10.000mm/10.000g/m² /24h) is for your days on the snow carving turns on the way down and enjoying the view from the lift on the way up.



black



back



dark blue



aruba green



metal blue



dust white



cloud pink



wild red

TECHNOLOGIES: DRYOsphere 2L, DUROloft
COMPOSITION: SHELL: 100% Polyester, LINING: 100% Polyester, FILL: 100% Polyester
INSULATION: 80g DUROloft
FIT: Athletic
APPROX. WEIGHT (KG): 600g
SIZE: EU XS-EU XXL
WATERPROOFNESS: 10.000 mm (JIS L1092 B)
BREATHABILITY: 10.000 g/m²/24hrs (JIS L 1099 B1 -inverted cup)

FEATURES:

- Zipped hand pockets under flaps
- Interior leg venting
- Adjustable waist
- CORDURA® abrasion resistant scuff panels
- Integrated snow gaiters

ECO-FEATURES:

- Recycled content
- PFC-Free DWR
- Bluesign® approved material



OUTERWEAR LAYERING



black



SCOTT EXPLORAIR ALPHA WOMEN'S HOODY

291817



This strategically mapped fleece, is the perfect layer for high-intensity activities like long ski-tours or intense ski days. The SCOTT Explorair Alpha hoody is the perfect piece for strategic layering all season long.



fir green/cloud pink

TECHNOLOGIES: Polartec® Alpha® Direct, Toray Airtastic™, Grid fleece knit
COMPOSITION: SHELL: 100% Polyamide, COATING: 100% Polyurethane, SHELL 2: 94% Polyester (recycled) 6% Elastane, LINING: 100% Polyester
INSULATION: 90g Polartec Alpha Direct
FIT: Athletic
APPROX. WEIGHT (KG): 310g
SIZE: EU XS-EU XXL

FEATURES:

- Zipped hand pockets
- Adjustable hem & hood
- Stretch knit cuffs
- Lightweight
- Hybrid construction

ECO-FEATURES:

- Re-source product
- Recycled content
- PFC-Free DWR

SCOTT EXPLORAIR ALPHA WOMEN'S VEST

291818



black



back

The Explorair Alpha Vest is the perfect addition to your layering collection if you are the ski touring enthusiast. It is the perfect spring touring piece.

TECHNOLOGIES: Polartec® Alpha® Direct, Toray Airtastic™, Grid fleece knit
COMPOSITION: SHELL: 100% Polyamide, COATING: 100% Polyurethane, SHELL 2: 94% Polyester (recycled) 6% Elastane, LINING: 100% Polyester
INSULATION: 90g Polartec Alpha Direct
FIT: Athletic
APPROX. WEIGHT (KG): 170g
SIZE: EU XS-EU XL

FEATURES:

- Zipped hand pockets
- Elastic bottom hem
- Lightweight
- Hybrid construction

ECO-FEATURES:

- Re-source product
- Recycled content
- PFC-Free DWR

SCOTT INSULOFT WARM WOMEN'S VEST



dust white/dust grey

The Insuloft Warm Vest is an easy layering addition to your pack when leaving for a week ski trip or to hang out in the resort during the spring season.

TECHNOLOGIES: DRYOsphere 2L, DUROloft ECO
COMPOSITION: SHELL: 100% Polyester, SHELL 2: 100% Polyester (recycled), LINING: 100% Polyester (recycled), FILL: 100% Polyester
INSULATION: DUROloft ECO insulation
FIT: Athletic
APPROX. WEIGHT (KG): 320g
SIZE: EU XS-EU XXL

FEATURES:

- Zipped hand pockets
- Adjustable hem & hood
- Reinforcement at shoulders

ECO-FEATURES:

- Re-source product
- Recycled content
- PFC-Free DWR

SCOTT EXPLORAIR ALPHA RAW WOMEN'S JACKET

291820



black



back

The Explorair Alpha Raw is a mix of technical and cosy, simple and efficient. Highly breathable, lightweight and warm it is a layer you will never leave at home during the winter season or during expeditions.

TECHNOLOGIES: Polartec® Alpha® Direct, Grid fleece knit
COMPOSITION: SHELL: 94% Polyester (recycled) 6% Elastane, SHELL 2: 100% Polyester
FIT: Athletic
APPROX. WEIGHT (KG): 180g
SIZE: EU XS-EU XL

FEATURES:

- Chest pocket
- Lightweight
- Hybrid construction

ECO-FEATURES:

- Re-source product
- Recycled content
- PFC-Free DWR

SCOTT INSULOFT STRETCH WOMEN'S JACKET

408790



black



back



northern mint green



cloud pink

A fully stretchable insulator with a clean, minimalist design. One of our warmest insulators, it features a seamless baffle construction to keep the heat in, and the cold out.

TECHNOLOGIES: DUROloft ECO, DUROxpan
COMPOSITION: SHELL: 86% Polyamide 14% Elastane, FILL: 100% Polyester (recycled)
INSULATION: DUROloft ECO insulation
FIT: Athletic
APPROX. WEIGHT (KG): 450g
SIZE: EU XS-EU XL

FEATURES:

- Zipped hand pockets
- Seamless baffle construction
- Elastic bottom hem and cuffs
- Stretch

ECO-FEATURES:

- Recycled content
- PFC-Free DWR

SCOTT INSULOFT WARM WOMEN'S JACKET

291824



dark blue



back



wild red

The SCOTT Insuloft Warm Jacket is water repellent and warm, it is the perfect layer for after-ski sledging or hanging out at the hut or in the resort.

TECHNOLOGIES: DRYOsphere 2L, DUROloft ECO
COMPOSITION: SHELL: 100% Polyester, SHELL 2: 100% Polyester (recycled), LINING: 100% Polyester (recycled), FILL: 100% Polyester
INSULATION: DUROloft ECO insulation
FIT: Athletic
APPROX. WEIGHT (KG): 570g
SIZE: EU XS-EU XXL

FEATURES:

- Zipped hand pockets
- Adjustable hem & hood
- Reinforcement at shoulders

ECO-FEATURES:

- Re-source product
- Recycled content
- PFC-Free DWR

SCOTT INSULOFT LIGHT WOMEN'S HOODY

291826



black



back



fir green



heather purple

The Insuloft Light hoody is our most versatile insulator. Part of our Re-Source line, it features a clean design and enhanced freedom of movement. It's a foundational piece for any year-round outdoor enthusiasts.

TECHNOLOGIES: DUROloft ECO, Toray Airtastic™, Brushed fleece knit
COMPOSITION: SHELL: 100% Polyamide, COATING: 100% Polyurethane, SHELL 2: 63% Polyester (recycled) 37% Polyester, LINING: 100% Polyester (recycled), PADDING: 100% Polyester (recycled)
INSULATION: 60g DUROloft ECO
FIT: Athletic
APPROX. WEIGHT (KG): 320g
SIZE: EU XS-EU XL

FEATURES:

- Packable
- Zipped hand pockets
- Adjustable hem & hood
- Stretch knit cuffs
- Stretch underarm & side panels
- Lightweight

ECO-FEATURES:

- Re-source product
- Recycled content
- PFC-Free DWR

SCOTT INSULOFT TECH PRIMALOFT WOMEN'S HOODY

408791



Feels like down, looks like down. The Tech Primaloft line of insulators features an ultralight 15D outer fabric and Primaloft ThermoPlume insulation, making it our warmest, lightest and most packable insulator in the line.

TECHNOLOGIES: Primaloft® ThermoPlume®
COMPOSITION: 100% Polyamide, FILL: 100% Polyester (recycled)
FIT: Athletic
APPROX. WEIGHT (KG): 420g
SIZE: EU XS-EU XL

FEATURES:
• Packable
• Zipped hand pockets
• Adjustable hood
• Elastic binding at hem
• Hood & cuffs
• Lightweight
ECO-FEATURES:
• Recycled content
• PFC-Free DWR



black



back



aruba green



dust white



cloud pink

SCOTT INSULOFT TECH PRIMALOFT WOMEN'S JACKET

408792



Feels like down, looks like down. The Tech Primaloft line of insulators features an ultralight 15D outer fabric and Primaloft ThermoPlume insulation, making it our warmest, light and most packable insulator in the line.

TECHNOLOGIES: Primaloft® ThermoPlume®
COMPOSITION: 100% Polyamide, FILL: 100% Polyester (recycled)
FIT: Athletic
APPROX. WEIGHT (KG): 400g
SIZE: EU XS-EU XL

FEATURES:
• Zipped hand pockets
• Adjustable hem & hood
• Packable
• Lightweight
ECO-FEATURES:
• Recycled content
• PFC-Free DWR



fir green



back



metal blue



dust white



wild red

SCOTT INSULOFT TECH WOMEN'S SHORTS

408961



Feels like down, looks like down. The Insuloft Tech shorts are designed with an ultralight 15D outer fabric and DUROloft insulation, giving them an excellent warmth-to-weight ratio.

TECHNOLOGIES: Duroloft ECO
COMPOSITION: SHELL: 100% Polyamide, SHELL 2: 70% Polyester (recycled) 30% Polyester, LINING: 100% Polyester (recycled), FILL: 100% Polyester (recycled)
FIT: Athletic
APPROX. WEIGHT (KG): 370g
SIZE: EU XS-EU XL

FEATURES:
• 1 zipped pocket
ECO-FEATURES:
• Recycled content
• PFC-Free DWR



black



back

SCOTT DEFINED WARM HYBRID WOMEN'S HOODY



The warmest fleece of the line combines the best of both worlds: windproof and insulated in the front, with soft fleece on the sleeves and back. Stretchable, warm, and breathable, this piece is a must-have on the slopes.

TECHNOLOGIES: DUROloft ECO
COMPOSITION: SHELL: 91% Polyester (recycled) 9% Lyocell, SHELL 2: 86% Polyamide 14% Elastane, FILL: 100% Polyester (recycled)
INSULATION: DUROloft ECO insulation
FIT: Regular
APPROX. WEIGHT (KG): 420g
SIZE: EU XS-EU XL

FEATURES:
• Zipped hand pockets
• Seamless baffle construction
• Hybrid construction
ECO-FEATURES:
• Re-source product
• Recycled content
• PFC-Free DWR



black



back



dark blue

SCOTT DEFINED HERITAGE PILE WOMEN'S JACKET

411129



The Defined Heritage pile fleece jacket gives you that retro look. Featuring a warm pile fleece knitted fabric, this is definitely an everyday essential.

TECHNOLOGIES: Pile fleece knit
COMPOSITION: 100% Polyester
FIT: Regular
APPROX. WEIGHT (KG): 530g
SIZE: EU XS-EU XL

FEATURES:
• Zipped hand pockets
• Elastic bottom hem and cuffs
ECO-FEATURES:
• Recycled content
• PFC-Free DWR



black



back



fir green



dust white

SCOTT DEFINED OPTIC WOMEN'S HOODY

283801



The SCOTT Defined Optic Jacket sports a classic sweater look, while using the highest quality fabrics SCOTT is known for, ensuring that you stay warm and stylish whether it is at the resort or out in the town.

TECHNOLOGIES: Sweater knit
COMPOSITION: SHELL: 100% Polyester (recycled), SHELL 2: 100% Polyester, LINING: 100% Polyester (recycled), FILL: 100% Polyester
FIT: Athletic
APPROX. WEIGHT (KG): 500g
SIZE: EU XS-EU XL

FEATURES:
• Hand pockets
• Hybrid construction
ECO-FEATURES:
• Recycled content
• PFC-Free DWR



dark blue



back



dust white

SCOTT DEFINED TECH WOMEN'S HOODY

410986



black

The Defined Tech is a staple of every outdoor enthusiast's closet. Designed with freedom of movement, breathability and moisture management in mind, it is the one layer every versatile skier needs.

TECHNOLOGIES: Grid fleece knit
COMPOSITION: 94% Polyester (recycled)
 6% Elastane
FIT: Athletic
APPROX. WEIGHT (KG): 330g
SIZE: EU XS-EU XL

FEATURES:
 • Zipped hand pockets
 • Elastic binding at hood
 • Stretch
ECO-FEATURES:
 • Re-source product
 • Recycled content
 • Bluesign® approved material



metal blue

SCOTT DEFINED MID WOMEN'S HOODY



black



back



metal blue/dark blue



dust white



cloud pink



aruba green/northern
mint green

The Defined Mid hoody is a lifestyle yet technical hoody. Sporty, it is the kind of layer you will use for any activity in the resorts.

TECHNOLOGIES: Brushed fleece knit
COMPOSITION: 63% Polyester (recycled)
 37% Polyester
FIT: Athletic
APPROX. WEIGHT (KG): 330g
SIZE: EU XS-EU XL

FEATURES:
 • Zipped hand pockets
 • Stretch
ECO-FEATURES:
 • Re-source product
 • Recycled content

SCOTT DEFINED TECH WOMEN'S JACKET

411128



black



back



dark blue/metal blue



heather purple



northern mint green/aruba
green

The Defined Tech is a staple of every outdoor enthusiast's closet. Designed with freedom of movement, breathability and moisture management in mind, it is the one layer every versatile skier needs.

TECHNOLOGIES: Grid fleece knit
COMPOSITION: 94% Polyester (recycled)
 6% Elastane
FIT: Athletic
APPROX. WEIGHT (KG): 300g
SIZE: EU XS-EU XL

FEATURES:
 • Zipped hand pockets
 • Stretch
ECO-FEATURES:
 • Re-source product
 • Recycled content
 • Bluesign® approved material

SCOTT DEFINED MID WOMEN'S PULLOVER HOODY

294675



black



back



fir green



metal blue



dust white



heather purple

The Defined Mid hoody is a lifestyle yet technical hoody. Sporty, it is the kind of layer you will use for any activity in the resorts.

TECHNOLOGIES: Brushed fleece knit
COMPOSITION: 63% Polyester (recycled)
 37% Polyester
FIT: Athletic
APPROX. WEIGHT (KG): 330g
SIZE: XS-XL

FEATURES:
 • Zipped hand pockets
 • Adjustable hood
 • Stretch
ECO-FEATURES:
 • Re-source product
 • Recycled content

SCOTT DEFINED ORIGINAL FLEECE WOMEN'S PULLOVER

291830



fir green/cloud pink



back

The defined original fleece is one of our versatile winter layer. Warm and inspired by the 90s, you can wear it in the resort as a sporty casual look as well as with jeans and nice sneakers in the city for a more retro style.

TECHNOLOGIES: Pile fleece knit
COMPOSITION: 100% Polyester (recycled)
FIT: Athletic
APPROX. WEIGHT (KG): 410g
SIZE: EU XS-EU XL

FEATURES:
 • Small chest pocket
 • Half zip
 • Elastic binding at hem
 • Hood & cuffs
ECO-FEATURES:
 • Re-source product
 • Recycled content

SCOTT DEFINED LIGHT WOMEN'S PULLOVER

291834



black



back



dark blue



dust white



aruba green/northern
mint green



wild red/cloud pink

A polyester blend with a delightful soft-brushed back, the SCOTT Defined Light Women's Pullover is a great transitional piece that can be worn next to the skin or as a mid-layer.

TECHNOLOGIES: Grid fleece knit
COMPOSITION: 94% Polyester (recycled)
 6% Elastane
FIT: Athletic
APPROX. WEIGHT (KG): 185g
SIZE: EU XS-EU XL

FEATURES:
 • Quarter zip
 • Highly breathable
 • Stretch
 • Lightweight
ECO-FEATURES:
 • Re-source product
 • Recycled content

SCOTT DEFINED MERINO LONG-SLEEVE WOMEN'S SHIRT

277793



dark blue/light grey melange



back



aruba green

SCOTT Merino base layers are naturally performing for all your outdoor activities. The thermal regulation and high breathability work as a second skin, performing in winter or summer and backing you up from first lift to last call. They have excellent moisture management, enhanced odor management and a soft feel.

TECHNOLOGIES: Merino Wool
COMPOSITION: 100% Wool (merino)
FIT: Slim
APPROX. WEIGHT (KG): 220g
SIZE: EU XS-EU XL

FEATURES:
 • Seasonal graphic print
ECO-FEATURES:
 • Re-source product
 • Recycled content
 • Mulesing-free Merino Wool

SCOTT DEFINED MERINO WOMEN'S PANTS

277794



dark blue/light grey melange



back



aruba green

SCOTT Merino base layers are naturally performing for all your outdoor activities. The thermal regulation and high breathability work as a second skin, performing in winter or summer and backing you up from first lift to last call. They have excellent moisture management, enhanced odor management and a soft feel.

TECHNOLOGIES: Merino Wool
COMPOSITION: 100% Wool (merino)
FIT: Slim
APPROX. WEIGHT (KG): 180g
SIZE: EU XS-EU XL

FEATURES:
 • Elastic waistband
ECO-FEATURES:
 • Re-source product
 • Recycled content
 • Mulesing-free Merino Wool

SCOTT VERTIC DRYO 10 JUNIOR JACKET

412137

The Vertic Dryo 10 jacket ensures a fit that will keep young freeskiers performing at their best from the first chair to the last. Made with a DRYOsphere 2L waterproof fabric, this jacket will keep the youngsters protected on the slopes for multiple seasons to come.

- TECHNOLOGIES:** DRYOsphere 2L
COMPOSITION: SHELL: 100% Polyester, LINING: 100% Polyester (recycled), Lining 2: 100% Polyamide, FILL: 100% Polyester
FIT: Regular
APPROX. WEIGHT (KG): 700g
SIZE: S (128)-XL (164)
- WATERPROOFNESS:** 10.000 mm (JIS L1092 B)
BREATHABILITY: 10.000 g/m²/24hrs (JIS L 1099 B1 -inverted cup)
FEATURES:
 • Zipped hand pockets under flaps
 • Adjustable cuffs
 • Detachable powder skirt
 • Ready-made for grow-it sleeve extension
ECO-FEATURES:
 • PFC-Free DWR



SCOTT ULTIMATE WARM JUNIOR JACKET



This jacket is an absolute essential for colder days on the slopes. With DUROloft ECO insulation, you'll never be cold, and the DRYOsphere 2-layer outer fabric will keep you dry in fleeting snowfall.

- TECHNOLOGIES:** DRYOsphere 2L, DUROloft ECO
COMPOSITION: SHELL: 100% Polyester, LINING: 100% Polyester (recycled), Lining 2: 100% Polyamide, FILL: 100% Polyester
INSULATION: DUROloft insulation
FIT: Regular
APPROX. WEIGHT (KG): 650g
SIZE: S (128)-XL (164)
- WATERPROOFNESS:** 10.000 mm (JIS L1092 B)
BREATHABILITY: 10.000 g/m²/24hrs (JIS L 1099 B1 -inverted cup)
FEATURES:
 • Zipped hand pockets
 • Adjustable cuffs
 • Powder skirt
 • Ready-made for grow-it sleeve extension
ECO-FEATURES:
 • Recycled content
 • PFC-Free DWR



SCOTT VERTIC DRYO 10 JUNIOR ANORAK

414303

The Vertic Dryo 10 anorak ensures a fit that will keep young freeskiers performing at their best from the first chair to the last. Made with a DRYOsphere 2L waterproof fabric, this jacket will keep the youngsters protected on the slopes for multiple seasons to come.

- TECHNOLOGIES:** DRYOsphere 2L
COMPOSITION: SHELL: 100% Polyester, LINING: 100% Polyester (recycled), Lining 2: 100% Polyamide, FILL: 100% Polyester
FIT: Regular
APPROX. WEIGHT (KG): 680g
SIZE: S (128)-XL (164)
- WATERPROOFNESS:** 10.000 mm (JIS L1092 B)
BREATHABILITY: 10.000 g/m²/24hrs (JIS L 1099 B1 -inverted cup)
FEATURES:
 • Zipped hand pockets
 • Adjustable cuffs
 • Powder skirt
 • Ready-made for grow-it sleeve extension
ECO-FEATURES:
 • PFC-Free DWR



SCOTT B ULTIMATE DRYO 10 JUNIOR'S JACKET

291873



The JR B Ultimate Dryo 10 is our teen all-mountain jacket. It features the same technical details as the adult version, plus the Grow-it sleeve extensions so that the jacket can keep up with the growth spurts. Whether your kids enjoy skiing on the piste, sledging or snowball fights, this is the perfect jacket for all their snowy adventures.

- TECHNOLOGIES:** DRYOsphere 2L, DUROloft
COMPOSITION: SHELL: 100% Polyester, LINING: 100% Polyester (recycled), Lining 2: 100% Polyamide, FILL: 100% Polyester
FIT: Athletic
APPROX. WEIGHT (KG): 650g
WATERPROOFNESS: 10.000 mm (JIS L1092 B)
BREATHABILITY: 10.000 g/m²/24hrs (JIS L 1099 B1 -inverted cup)
- SIZE:** S-XL
FEATURES:
 • Powder skirt
 • Fixed hood
 • Armpit venting
 • Hand warmer and sleeve pass pocket
 • Internal security pocket
 • Adjustable hem
 • Adjustable cuffs
 • Anti-chafe chin guard
 • Cord loop at inside hem for glove attachment
 • Ready-made for grow-it sleeve extension
 • Articulated sleeves
 • Fully taped seams
ECO-FEATURES:
 • PFC-Free DWR
 • Bluesign® approved material



SCOTT VERTIC BIB JUNIOR PANTS

412153

There's no compromising on style with the relaxed freeride fit of the SCOTT Vertic Junior Pants. Unique features include the ready-made hem growth extensions, so you can extend the legs of the pants up to 3cm.

- TECHNOLOGIES:** DRYOsphere 2L
COMPOSITION: 100% Polyester, FILL: 100% Polyester
FIT: Regular
APPROX. WEIGHT (KG): 680g
SIZE: S (128)-XL (164)
- WATERPROOFNESS:** 10.000 mm (JIS L1092 B)
BREATHABILITY: 10.000 g/m²/24hrs (JIS L 1099 B1 -inverted cup)
FEATURES:
 • High waist bib with stretchable side & back panels & adjustable suspenders
 • Zipped hand pockets
 • Integrated snow gaiters
 • Ready-made for grow-it 2" cuff & gaiter extension
ECO-FEATURES:
 • PFC-Free DWR



SCOTT G ULTIMATE DRYO 10 JUNIOR'S JACKET

291874



The JR G Ultimate Dryo 10 is our teen all-mountain jacket. It features the same technical details as the adult version, plus the grow-it sleeve extensions so that the jacket can keep up with the growth spurts. Whether your kids enjoy skiing on the piste, sledging or snowball fights, this is the perfect jacket for all their snowy adventures.

- TECHNOLOGIES:** DRYOsphere 2L, DUROloft
COMPOSITION: SHELL: 100% Polyester, LINING: 100% Polyester (recycled), Lining 2: 100% Polyamide, FILL: 100% Polyester
FIT: Athletic
APPROX. WEIGHT (KG): 650g
WATERPROOFNESS: 10.000 mm (JIS L1092 B)
BREATHABILITY: 10.000 g/m²/24hrs (JIS L 1099 B1 -inverted cup)
- SIZE:** S-XL
FEATURES:
 • Powder skirt
 • Fixed hood
 • Armpit venting
 • Hand warmer and sleeve pass pocket
 • Internal security pocket
 • Adjustable hem
 • Adjustable cuffs
 • Anti-chafe chin guard
 • Cord loop at inside hem for glove attachment
 • Ready-made for grow-it sleeve extension
 • Articulated sleeves
 • Fully taped seams
ECO-FEATURES:
 • Bluesign® approved material
 • PFC free DWR



SCOTT ULTIMATE DRYO 10 JUNIOR PANTS

412165



The SCOTT Ultimate Dryo 10 Junior pants utilize DRYOsphere waterproofing to prevent wind and water from seeping in, while keeping the pants breathable.



black



back



northern mint green



fir green



heather purple

TECHNOLOGIES: DRYOsphere 2L, DUROloft
COMPOSITION: SHELL: 100% Polyester,
 LINING: 100% Polyester,
 LINING 2: 100% Polyester (recycled),
 FILL: 100% Polyester
FIT: Athletic
APPROX. WEIGHT (KG): 580g
SIZE: S (128)-XL (164)

WATERPROOFNESS: 10.000 mm
 (JIS L1092 B)
BREATHABILITY: 10.000 g/m²/24hrs
 (JIS L 1099 B1 -inverted cup)
FEATURES:
 • Adjustable suspenders
 • Zipped hand pockets
 • Integrated snow gaiters
 • Ready-made for grow-it 2" cuff & gaiter extension
ECO-FEATURES:
 • Recycled content

SCOTT ORIGINAL FLEECE JUNIOR PULLOVER

412164



The Defined Original fleece is one of our most versatile winter layers. Warm and inspired by the 90s, you can wear it in the resort for a sporty casual look, or pair with jeans and nice sneakers in the city for a more retro style.



fir green



back



phantom purple



northern mint green/aruba green

TECHNOLOGIES: Pile fleece knit
COMPOSITION: 100% Polyester (recycled)
FIT: Regular
APPROX. WEIGHT (KG): 300g
SIZE: S (128)-XL (164)

FEATURES:
 • Snap button collar closure
ECO-FEATURES:
 • Re-source product
 • Recycled content

GLOVES



SCOTT EXPLORAIR ALPINE GLOVE

291895



black



back



dark grey/burnt orange

Optimum in terms of warmth, the Explorair Alpine is our most protective glove. Specifically made for exploration and mountaineering expeditions, it offers practical features like long gauntlets for harsh conditions or removable interior fleece gloves for the base camp which dry better and are comfortable for sleeping in bivouac.

TECHNOLOGIES: DRYOsphere insert, Primaloft® Insulation

COMPOSITION: SHELL: 58% Goat leather, 20% Polyester (recycled) 15% Polyester, 7% Cotton, **SHELL 2:** 100% Polyamide, **INSERT:** 100% Polyethylene, **FILL:** 100% Polyester, **LINING:** 94% Polyester, 6% Wool

INSULATION: BOH: 130g Primaloft® Gold

FIT: Regular

SIZE: S-XL

FEATURES:

- Lobster mitten with 3-finger liner
- Removable insulated liner
- Long adjustable gauntlet designed to fit over jacket
- Leather reinforcements on thumb
- Heat-resistant DuPont™ Kevlar® thread on palm reinforcements
- Carabiner loop
- Adjustable wrist cord

SCOTT EXPLORAIR PREMIUM GTX GLOVE

244440



black



dark grey/burnt orange

The SCOTT Explorair Premium GTX Glove is made for high-mountainering and backcountry touring expeditions. The strong leather construction, combined with the GORE-TEX® inserts with Gore active technology, allows the glove to keep you warm on the cold days without sacrificing dexterity.

TECHNOLOGIES: GORE-TEX® insert with GORE Active Technology, Primaloft® Insulation

COMPOSITION: SHELL: 76% Goat leather, 11% Polychloroprene, 11% Polyamide, 2% Elastane, **FILL:** 100% Polyester, **LINING:** 66% Polyester, 34% Wool

INSULATION: BOH: 100g Primaloft® Gold, **PALM:** 60g Primaloft® Gold

FIT: Regular

SIZE: S-XL

FEATURES:

- Leather reinforcements on index finger and thumb
- Reinforced palm
- Heat-resistant DuPont™ Kevlar® thread on palm reinforcements
- Roll up finger construction
- Carabiner loop
- Velcro closure

SCOTT EXPLORAIR PLUS GLOVE

277921



black



back



burnt orange

The SCOTT Explorair Plus is one of our freeride gloves. Its leather construction mixed with nylon, enhance the resistance of the panels while the 200g Primaloft® Gold insulation and GORE-TEX® Infinium provide primary warmth against harsh conditions during your big mountain adventures.

TECHNOLOGIES: GORE-TEX® Infinium Windstopper back of hand lining, Primaloft® Insulation

COMPOSITION: SHELL: 90% Goat leather 9% Polyamide 1% Elastane, **FILL:** 100% Polyester, **LINING:** 100% Polyester

INSULATION: BOH: 200g Primaloft® Gold, **PALM:** 130g Primaloft® Gold

FIT: Regular

SIZE: S-XL

FEATURES:

- Leather reinforcements on index finger and thumb
- Reinforced palm
- Heat-resistant DuPont™ Kevlar® thread on palm reinforcements
- External palm side finger seams
- Carabiner loop
- Velcro closure

SCOTT EXPLORAIR SPRING GLOVE

The SCOTT Explorair Spring is a light and highly versatile glove for long ascents. With no insulation, it is the go-to glove for high-intensity spring activities.

COMPOSITION: SHELL: 78% Goat leather, 16% Polyamide, 3% Polychloroprene, 3% Elastane, **LINING:** 100% Polyester

FIT: Regular

SIZE: XS-XL

FEATURES:

- Durable goat leather palm
- Carabiner loop
- Wrist adjustment



black



back

SCOTT EXPLORAIR ASCENT GLOVE

277924

The SCOTT Explorair Ascent is a light, stretch and windproof glove for long ski tours in sunny winter days. Its leather palm and finger fourchette provide maximum durability. It is also the perfect glove for all your year around outdoor activities.

COMPOSITION: SHELL: 50% Goat leather, 40% Polyester, 6% Polyamide, 4% Elastane

FIT: Slim

SIZE: XS-XL

FEATURES:

- Windproof 2-way stretch softshell back of hand material
- Durable goat leather palm
- Flex zones on knuckles for enhanced articulation
- Microfiber nose wipe
- Carabiner loop
- Velcro closure



black



back

SCOTT EXPLORAIR WORK GLOVE

291896

Inspired by workwear gloves as a style statement and integrating a fleece lining in the inside to keep the hand warm, the Explorair Work glove is our most versatile model. The kind of glove you keep in your car and use for things as diverse as filling the fire place, on the slopes and to put chains on the tire. It is a must have for any adventure in the outdoors.

COMPOSITION: SHELL: 77% Goat leather, 12% Polyamide, 10% Polyurethane, 1% Elastane, **LINING:** 87% Polyester, 13% Acrylic

FIT: Regular

SIZE: XS-XL

FEATURES:

- Durable goat leather palm
- Sherpa fleece lining
- Stretch knit cuffs
- Workwear look
- Microfiber nose wipe



black



back

SCOTT ULTIMATE PREMIUM GORE-TEX® GLOVE

291897



The SCOTT Ultimate Premium GTX glove is designed for big mountain skiers and freeriders. Its GORE-TEX® inserts paired with reinforced leather palm and extra padding make it warm, comfortable and durable. It is a glove for expeditions or stormy weather conditions.



TECHNOLOGIES: GORE-TEX® insert with GORE Active Technology, DRYOsphere 2L back of hand material, DUROloft
COMPOSITION: SHELL: 31% Goat leather, 26% Polyester (recycled), 22% Polyester, 10% Cotton, 6% Polyurethane, 5% Polyamide, **FILL:** 100% Polyester, **LINING:** 74% Polyester, 26% Polyamide
INSULATION: BOH: 280g DUROloft, **PALM:** 220g DUROloft
FIT: Regular
SIZE: S-XXL

FEATURES:

- Durable goat leather palm
- Reinforced palm
- Long gauntlet designed to fit under jacket cuff
- Padded knuckle panel
- Touchscreen compatible index finger
- Adjustable wrist cord

ECO-FEATURES:

- PFC-Free DWR
- Recycled content

SCOTT ULTIMATE PLUS GLOVE



The SCOTT Ultimate Plus is a freeride and all mountain glove featuring a premium PrimaLoft® Gold insulation, a soft leather palm and a short, low-profile cuff. This glove is sure to keep you comfortable and stylish all winter long.



TECHNOLOGIES: DRYOsphere insert, DRYOsphere 3L back of hand material, PrimaLoft® Insulation
COMPOSITION: SHELL: 52% Goat leather, 25% Polyester, 15% Polyamide, 5% Polychloroprene 3% Polyurethane, **INSERT:** 100% Polyurethane, **FILL:** 100% Polyester, **LINING:** 100% Polyester
INSULATION: BOH: 200g PrimaLoft® Gold, **PALM:** 130g PrimaLoft® Gold
FIT: Regular
SIZE: S-XXL

FEATURES:

- Leather reinforcements on thumb
- Reinforced palm
- Padded leather knuckle panel
- Velcro closure
- Fleece lined

ECO-FEATURES:

- PFC-Free DWR

SCOTT ULTIMATE PREMIUM GORE-TEX® MITTEN

291898



The SCOTT Ultimate Premium GTX mitten is similar to the glove of the same name but in a lobster shape with a 3-finger liner. Its GORE-TEX® inserts paired with reinforced leather palm and extra padding make it warm, comfortable and durable. It is a glove for expeditions or stormy weather conditions.



TECHNOLOGIES: GORE-TEX® insert with GORE Active Technology, DRYOsphere 2L back of hand material, DUROloft
COMPOSITION: SHELL: 44% Goat leather, 19% Polyester (recycled), 17% Polyester, 8% Cotton, 6% Polyurethane, 6% Polyamide, **FILL:** 100% Polyester, **LINING:** 75% Polyester, 25% Polyamide
INSULATION: BOH: 280g DUROloft, **PALM:** 220g DUROloft
FIT: Regular
SIZE: S-XXL

FEATURES:

- Durable goat leather palm
- Reinforced palm
- Lobster mitten with 3-finger liner
- Long gauntlet designed to fit under jacket cuff
- Padded knuckle panel
- Touchscreen compatible index finger
- Adjustable wrist cord

ECO-FEATURES:

- PFC-Free DWR
- Recycled content

SCOTT ULTIMATE PLUS WOMEN'S GLOVE

291901



The SCOTT Women Ultimate Plus is a freeride and all mountain glove featuring a premium PrimaLoft® Gold insulation, a soft leather palm and a short, low-profile cuff. This glove is sure to keep you comfortable and stylish all winter long.



TECHNOLOGIES: DRYOsphere insert, DRYOsphere 3L back of hand material, PrimaLoft® Insulation
COMPOSITION: SHELL: 52% Goat leather, 25% Polyester, 15% Polyamide, 5% Polychloroprene, 3% Polyurethane, **INSERT:** 100% Polyurethane, **FILL:** 100% Polyester, **LINING:** 100% Polyester
INSULATION: BOH: 200g PrimaLoft® Gold, **PALM:** 130g PrimaLoft® Gold
FIT: Regular
SIZE: XS-L

FEATURES:

- Leather reinforcements on thumb
- Reinforced palm
- Padded leather knuckle panel
- Velcro closure
- Fleece lined

ECO-FEATURES:

- PFC-Free DWR

SCOTT ULTIMATE PREMIUM GORE-TEX® WOMEN'S GLOVE

291899



The SCOTT Ultimate Premium GTX glove is designed for big mountain skiers and freeriders. Its GORE-TEX® inserts paired with reinforced leather palm and extra padding make it warm, comfortable and durable. It is a glove for expeditions or stormy weather conditions.



TECHNOLOGIES: GORE-TEX® insert with GORE Active Technology, DRYOsphere 2L back of hand material, DUROloft
COMPOSITION: SHELL: 29% Goat leather, 27% Polyester (recycled), 22% Polyester, 10% Cotton, 6% Polyurethane, 6% Polyamide, **FILL:** 100% Polyester, **LINING:** 72% Polyester, 28% Polyamide
INSULATION: BOH: 280g DUROloft, **PALM:** 220g DUROloft
FIT: Regular
SIZE: XS-L

FEATURES:

- Durable goat leather palm
- Reinforced palm
- Long gauntlet designed to fit under jacket cuff
- Padded knuckle panel
- Touchscreen compatible index finger
- Adjustable wrist cord

ECO-FEATURES:

- PFC-Free DWR
- Recycled content

SCOTT ULTIMATE PLUS MITTEN

291902



The SCOTT Ultimate Plus is a freeride and all mountain mitten featuring a premium PrimaLoft® Gold insulation, a soft leather palm and a short, low-profile cuff. This mitten is sure to keep you comfortable and stylish all winter long.



TECHNOLOGIES: DRYOsphere insert, DRYOsphere 3L back of hand material, PrimaLoft® Insulation
COMPOSITION: SHELL: 52% Goat leather, 25% Polyester, 15% Polyamide, 5% Polychloroprene, 3% Polyurethane, **INSERT:** 100% Polyurethane, **FILL:** 100% Polyester, **LINING:** 100% Polyester
INSULATION: BOH: 200g PrimaLoft® Gold, **PALM:** 130g PrimaLoft® Gold
FIT: Regular
SIZE: S-XXL

FEATURES:

- Leather reinforcements on thumb
- Reinforced palm
- Padded leather knuckle panel
- Velcro closure
- Fleece lined

ECO-FEATURES:

- PFC-Free DWR

SCOTT ULTIMATE PLUS WOMEN'S MITTEN

291903



The SCOTT Women Ultimate Plus is a freeride and all mountain mitten featuring a premium PrimaLoft® Gold insulation, a soft leather palm and a short, low-profile cuff. This mitten is sure to keep you comfortable and stylish all winter long.

TECHNOLOGIES: DRYOsphere insert, DRYOsphere 3L back of hand material, PrimaLoft® Insulation

COMPOSITION: SHELL: 52% Goat leather, 25% Polyester, 15% Polyamide, 5% Polychloroprene, 3% Polyurethane, INSERT: 100% Polyurethane, FILL: 100% Polyester, LINING: 100% Polyester

INSULATION: BOH: 200g PrimaLoft® Gold, PALM: 130g PrimaLoft® Gold

FIT: Regular

SIZE: XS-L

FEATURES:

- Leather reinforcements on thumb
- Reinforced palm
- Padded leather knuckle panel
- Velcro closure
- Fleece lined

ECO-FEATURES:

- PFC-Free DWR



SCOTT ULTIMATE GORE-TEX® MITTEN



Constructed of light yet performance-driven materials and coupled with guaranteed waterproof and breathable GORE-TEX® inserts, the SCOTT Ultimate GTX Mitten promises to keep you dry and warm against variable weather elements. Its looser fit cuffs provide the comfort you need for all resort activities.

TECHNOLOGIES: GORE-TEX® insert, DRYOsphere 2L back of hand material, DUROloft

COMPOSITION: SHELL: 52% Polyurethane, 48% Polyamide, FILL: 100% Polyester, LINING: 75% Polyester, 25% Polyamide

INSULATION: BOH: 220g DUROloft, PALM: 170g DUROloft

FIT: Relaxed

SIZE: S-XXL

FEATURES:

- Fleece lined
- Adjustable wrist cord
- Wrist leash

ECO-FEATURES:

- PFC-Free DWR
- Recycled content



SCOTT ULTIMATE GORE-TEX® GLOVE

277941



Constructed of light yet performance-driven materials and coupled with guaranteed waterproof and breathable GORE-TEX® inserts, the SCOTT Ultimate GTX Glove promises to keep you dry and warm against variable weather elements. Its looser fit cuffs provide the comfort you need for all resort activities.

TECHNOLOGIES: GORE-TEX® insert, DRYOsphere 2L back of hand material, DUROloft

COMPOSITION: SHELL: 67% Polyamide, 33% Polyurethane, FILL: 100% Polyester, LINING: 75% Polyester, 25% Polyamide

INSULATION: BOH: 220g DUROloft, PALM: 170g DUROloft

FIT: Regular

SIZE: S-XXL

FEATURES:

- Fleece lined
- Adjustable wrist cord
- Wrist leash

ECO-FEATURES:

- PFC-Free DWR
- Recycled content



SCOTT ULTIMATE GORE-TEX® WOMEN'S MITTEN

277944



Constructed of light yet performance-driven materials and coupled with guaranteed waterproof and breathable GORE-TEX® inserts, the SCOTT Ultimate Women GTX Mitten promises to keep you dry and warm against variable weather elements. Its looser fit cuffs provide the comfort you need for all resort activities.

TECHNOLOGIES: GORE-TEX® insert, DRYOsphere 2L back of hand material, DUROloft

COMPOSITION: SHELL: 51% Polyamide, 49% Polyurethane, FILL: 100% Polyester, LINING: 75% Polyester, 25% Polyamide

INSULATION: BOH: 220g DUROloft, PALM: 170g DUROloft

FIT: Relaxed

SIZE: XS-L

FEATURES:

- Fleece lined
- Adjustable wrist cord
- Wrist leash

ECO-FEATURES:

- PFC-Free DWR
- Recycled content



SCOTT ULTIMATE GORE-TEX® WOMEN'S GLOVE

277943



Constructed of light yet performance-driven materials and coupled with guaranteed waterproof and breathable GORE-TEX® inserts, the SCOTT Ultimate Women GTX Glove promises to keep you dry and warm against variable weather elements. Its looser fit cuffs provide the comfort you need for all resort activities.

TECHNOLOGIES: GORE-TEX® insert, DRYOsphere 2L back of hand material, DUROloft

COMPOSITION: SHELL: 67% Polyamide, 33% Polyurethane, FILL: 100% Polyester, LINING: 75% Polyester, 25% Polyamide

INSULATION: BOH: 220g DUROloft, PALM: 170g DUROloft

FIT: Regular

SIZE: XS-L

FEATURES:

- Fleece lined
- Adjustable wrist cord
- Wrist leash

ECO-FEATURES:

- PFC-Free DWR
- Recycled content



SCOTT ULTIMATE HYBRID GLOVE

291904



The SCOTT Ultimate Hybrid is an all day and every day glove. Warm and soft, it will bring you comfort in all conditions and its waterproof fabric will keep you dry all day long.

TECHNOLOGIES: DRYOsphere insert, DRYOsphere 3L back of hand material, DUROloft

COMPOSITION: SHELL: 60% Polyester, 38% Polyurethane, 2% Polyamide, INSERT: 100% Polyurethane, FILL: 100% Polyester, LINING: 100% Polyester

INSULATION: BOH: 220g DUROloft, PALM: 180g DUROloft

FIT: Relaxed

SIZE: S-XXL

FEATURES:

- Padded knuckle panel
- Fleece lined
- Touchscreen compatible index finger
- Velcro closure
- Wrist leash

ECO-FEATURES:

- PFC-Free DWR



SCOTT ULTIMATE HYBRID WOMEN'S GLOVE

291905



The SCOTT Ultimate Women Hybrid is an all day and every day glove. Warm and soft, it will bring you comfort in all conditions and its waterproof fabric will keep you dry all day long.

TECHNOLOGIES: DRYOsphere insert, DRYOsphere 3L back of hand material, DUROloft

COMPOSITION: SHELL: 60% Polyester, 38% Polyurethane, 2% Polyamide, INSERT: 100% Polyurethane, FILL: 100% Polyester, LINING: 100% Polyester

INSULATION: BOH: 220g DUROloft, PALM: 180g DUROloft

FIT: Relaxed

SIZE: XS-L

FEATURES:

- Padded knuckle panel
- Fleece lined
- Touchscreen compatible index finger
- Velcro closure
- Wrist leash

ECO-FEATURES:

- PFC-Free DWR

SCOTT ULTIMATE WARM GLOVE



The SCOTT Ultimate Warm is an all mountain glove for holiday skiers who will enjoy a short stay on snow in cold but sunny weather conditions. It is the perfect glove if you sledge one day and ski another.

TECHNOLOGIES: DRYOsphere 2L back of hand material, DUROloft

COMPOSITION: SHELL: 80% Polyamide, 20% Polyurethane, INSERT: 100% Polyethylene, FILL: 100% Polyester, LINING: 100% Polyester

INSULATION: BOH: 280g DUROloft, PALM: 220g DUROloft

FIT: Relaxed

SIZE: S-XXL

FEATURES:

- Sherpa fleece lining
- Wrist adjustment
- Adjustable wrist cord
- Wrist leash

ECO-FEATURES:

- PFC-Free DWR
- Recycled content

SCOTT ULTIMATE HYBRID MITTEN

291906



The SCOTT Ultimate Hybrid is an all day and every day mitten. Warm and soft, it will bring you comfort in all conditions and its waterproof fabric will keep you dry all day long.

TECHNOLOGIES: DRYOsphere insert, DRYOsphere 3L back of hand material, DUROloft

COMPOSITION: SHELL: 60% Polyester, 38% Polyurethane, 2% Polyamide, INSERT: 100% Polyurethane, FILL: 100% Polyester, LINING: 100% Polyester

INSULATION: BOH: 220g DUROloft, PALM: 180g DUROloft

FIT: Relaxed

SIZE: S-XXL

FEATURES:

- Padded knuckle panel
- Fleece lined
- Velcro closure
- Wrist leash

ECO-FEATURES:

- PFC-Free DWR

SCOTT ULTIMATE WARM WOMEN'S GLOVE

277951



The SCOTT Ultimate Women Warm is an all mountain glove for holiday skiers who will enjoy a short stay on snow in cold but sunny weather conditions. It is the perfect glove if you sledge one day and ski another.

TECHNOLOGIES: DRYOsphere 2L back of hand material, DUROloft

COMPOSITION: SHELL: 80% Polyamide, 20% Polyurethane, INSERT: 100% Polyethylene, FILL: 100% Polyester, LINING: 100% Polyester

INSULATION: BOH: 280g DUROloft, PALM: 220g DUROloft

FIT: Relaxed

SIZE: XS-L

FEATURES:

- Sherpa fleece lining
- Wrist adjustment
- Adjustable wrist cord
- Wrist leash

ECO-FEATURES:

- PFC-Free DWR
- Recycled content

SCOTT ULTIMATE HYBRID WOMEN'S MITTEN

291907



The SCOTT Ultimate Women Hybrid is an all day and every day mitten. Warm and soft, it will bring you comfort in all conditions and its waterproof fabric will keep you dry all day long.

TECHNOLOGIES: DRYOsphere insert, DRYOsphere 3L back of hand material, DUROloft

COMPOSITION: SHELL: 60% Polyester, 38% Polyurethane, 2% Polyamide, INSERT: 100% Polyurethane, FILL: 100% Polyester, LINING: 100% Polyester

INSULATION: BOH: 220g DUROloft, PALM: 180g DUROloft

FIT: Relaxed

SIZE: XS-L

FEATURES:

- Padded knuckle panel
- Fleece lined
- Velcro closure
- Wrist leash

ECO-FEATURES:

- PFC-Free DWR

SCOTT ULTIMATE WARM MITTEN

277950



The SCOTT Ultimate Warm is an all mountain mitten for holiday skiers who will enjoy a short stay on snow in cold but sunny weather conditions. It is the perfect mitten if you sledge one day and ski another.

TECHNOLOGIES: DRYOsphere 2L back of hand material, DUROloft

COMPOSITION: SHELL: 80% Polyamide, 20% Polyurethane, INSERT: 100% Polyethylene, FILL: 100% Polyester, LINING: 100% Polyester

INSULATION: BOH: 280g DUROloft, PALM: 220g DUROloft

FIT: Relaxed

SIZE: S-XXL

FEATURES:

- Sherpa fleece lining
- Wrist adjustment
- Adjustable wrist cord
- Wrist leash

ECO-FEATURES:

- PFC-Free DWR
- Recycled content

SCOTT ULTIMATE WARM WOMEN'S MITTEN

277952



The SCOTT Ultimate Women Warm is an all mountain mitten for holiday skiers who will enjoy a short stay on snow in cold but sunny weather conditions. It is the perfect mitten if you sledge one day and ski another.

TECHNOLOGIES: DRYOsphere 2L back of hand material, DUROloft

COMPOSITION: SHELL: 80% Polyamide, 20% Polyurethane, **INSERT:** 100% Polyethylene, **FILL:** 100% Polyester, **LINING:** 100% Polyester

INSULATION: BOH: 280g DUROloft, **PALM:** 220g DUROloft

FIT: Relaxed

SIZE: XS-L

FEATURES:

- Sherpa fleece lining
- Wrist adjustment
- Adjustable wrist cord
- Wrist leash

ECO-FEATURES:

- PFC-Free DWR
- Recycled content

SCOTT FLEECE LINER GLOVE

277962

The SCOTT Fleece Liner can be used as an inner glove or worn alone while enjoying laps in a resort when the weather warms up. Featuring anti-pilling fleece, conductive thread for touchscreen compatibility and silicone grip for secure contact to your poles, it is the perfect carry-on glove when the weather cools down.

COMPOSITION: SHELL: 96% Polyester, 4% Elastane

FIT: Slim

SIZE: XS-XL

FEATURES:

- Soft touch for a great wearing comfort
- Touchscreen compatible index finger and thumb
- Silicone print for better grip



SCOTT WINTER STRETCH LF GLOVE

275401



When winter threatens to discourage you from venturing out, you can turn to the SCOTT Winter Stretch Long-finger glove to save the day. Featuring GORE-TEX® INFINIUM™ lightweight fabric with optimal breathability and windproof properties, along with a pre-shaped construction, this glove is engineered to combat varying weather conditions.

TECHNOLOGIES: GORE-TEX® INFINIUM™ garments with WINDSTOPPER® product technology

COMPOSITION: 92% Polyester, 8% Elastane

FIT: Slim

SIZE: XS-XL

FEATURES:

- Windproof
- Silicone print for better grip
- Touchscreen compatible index finger and thumb
- Silicone pull tab for easy entry
- Reflective details

JUNIOR LINE

SCOTT ULTIMATE PREMIUM GORE-TEX® JUNIOR'S GLOVE



Constructed with light yet high-performing materials and featuring waterproof and breathable GORE-TEX® inserts, the SCOTT Ultimate GTX glove promises to keep little hands dry and warm in variable conditions. Its looser-fit cuffs ensure comfort for all resort activities.

TECHNOLOGIES: GORE-TEX® insert, DRYOsphere 2L back of hand material, DUROloft

COMPOSITION: SHELL: 64% Polyamide, 36% Polyurethane, **FILL:** 100% Polyester, **LINING:** 68% Polyester, 32% Polyamide

INSULATION: BOH: 170g DUROloft, **PALM:** 140g DUROloft

FIT: Relaxed

SIZE: S-XL

FEATURES:

- Fleece lined
- Roll up finger construction
- Wrist adjustment
- Adjustable wrist cord
- Wrist leash

ECO-FEATURES:

- PFC-Free DWR
- Recycled content

SCOTT ULTIMATE PREMIUM JUNIOR'S GLOVE

413241



The SCOTT Ultimate Premium Junior glove combines warmth and protection for pint-sized weekend warriors.

TECHNOLOGIES: DRYOsphere insert, DRYOsphere 3L back of hand material, DUROloft

COMPOSITION: SHELL: 45% Polyester, 35% Polyamide, 10% Polyurethane, 5% Elastane, 5% Polychloroprene, **INSERT:** 100% Polyurethane, **FILL:** 100% Polyester, **LINING:** 100% Polyester

INSULATION: BOH: 280g DUROloft, **PALM:** 220g DUROloft

FIT: Relaxed

SIZE: S-XL

FEATURES:

- Back of hand pocket with waterproof zipper for heat pack storage
- Fleece lined
- Wrist adjustment
- Adjustable wrist cord
- Wrist leash

ECO-FEATURES:

- PFC-Free DWR

SCOTT ULTIMATE PREMIUM JUNIOR'S MITTEN

413242



The SCOTT Ultimate Premium Junior mitten combines warmth and protection for pint-sized weekend warriors.

TECHNOLOGIES: DRYOsphere insert, DRYOsphere 3L back of hand material, DUROloft

COMPOSITION: SHELL: 45% Polyester, 35% Polyamide, 10% Polyurethane, 5% Elastane, 5% Polychloroprene, **INSERT:** 100% Polyurethane, **FILL:** 100% Polyester, **LINING:** 100% Polyester

INSULATION: BOH: 280g DUROloft, **PALM:** 220g DUROloft

FIT: Relaxed

SIZE: S-XL

FEATURES:

- Back of hand pocket with waterproof zipper for heat pack storage
- Fleece lined
- Wrist adjustment
- Adjustable wrist cord
- Wrist leash

ECO-FEATURES:

- PFC-Free DWR

SCOTT ULTIMATE JUNIOR'S GLOVE

277959



Basic winter warmth in a kid-friendly package, the SCOTT Ultimate Junior Glove delivers warmth and protection in a reliable glove.

TECHNOLOGIES: DRYOsphere insert, DRYOsphere 3L back of hand material, DUROloft

COMPOSITION: SHELL: 45% Polyester, 35% Polyamide, 10% Polyurethane, 5% Elastane, 5% Polychloroprene, INSERT: 100% Polyurethane, FILL: 100% Polyester, LINING: 100% Polyester

INSULATION: BOH: 220g DUROloft, PALM: 180g DUROloft

FIT: Relaxed

SIZE: S-XL

FEATURES:

- Fleece lined
- Adjustable wrist cord
- Wrist leash

ECO-FEATURES:

- PFC-Free DWR

SCOTT ULTIMATE JUNIOR'S MITTEN

277960



Basic winter warmth in a kid-friendly package, the SCOTT Ultimate Junior Mitten delivers warmth and protection in a reliable mitten-style glove.

TECHNOLOGIES: DRYOsphere insert, DRYOsphere 3L back of hand material, DUROloft

COMPOSITION: SHELL: 45% Polyester, 35% Polyamide, 10% Polyurethane, 5% Elastane, 5% Polychloroprene, INSERT: 100% Polyurethane, FILL: 100% Polyester, LINING: 100% Polyester

INSULATION: BOH: 220g DUROloft, PALM: 180g DUROloft

FIT: Relaxed

SIZE: S-XL

FEATURES:

- Fleece lined
- Adjustable wrist cord
- Wrist leash

ECO-FEATURES:

- PFC-Free DWR

SCOTT ULTIMATE TOT JUNIOR'S MITTEN

291912



The SCOTT Ultimate Tot Junior Mitten combines quality, warmth and practicality in a fun package designed specifically for tiny hands. Parents enjoy an easier on/off with an extended gauntlet side-zip and our new addition of a wrist leash. The kids enjoy the fun colors and all-day warmth. The graphics is matching with our kids goggle collection for more fun.

TECHNOLOGIES: DRYOsphere 2L back of hand material, DUROloft

COMPOSITION: SHELL: 70% Polyester, 30% Polyurethane, FILL: 100% Polyester, LINING: 100% Polyester

INSULATION: BOH: 220g DUROloft, PALM: 180g DUROloft

FIT: Relaxed

SIZE: S-L

FEATURES:

- Fleece lined
- Extra long gauntlet
- Gauntlet zipper for easy and Kid-friendly entry
- Wrist leash

ECO-FEATURES:

- PFC-Free DWR
- Recycled content

BEANIES
& ACCESSORIES



ACCESSORIES

SCOTT 5-PANEL ORIGINAL FLEECE CAP 412773



COMPOSITION: SHELL: 100% Polyester, SHELL 2: 92% Polyester 8% Elastane
SIZE: One size
FIT: Regular

SCOTT HERITAGE PILE CAP 412774



COMPOSITION: SHELL: 100% Cotton, LINING: 100% Polyester
SIZE: One size
FIT: Regular

SCOTT FLEECE LIGHTWEIGHT BEANIE (PACK 3) 419400



TECHNOLOGIES: Grid fleece knit, DUROxpend
COMPOSITION: SHELL: 94% Polyester 6% Elastane
FIT: Athletic
SIZE: One size
FEATURES: - Quick-dry

SCOTT LINER MERINO BEANIE (PACK 3) 419402



TECHNOLOGIES: Merino Wool
COMPOSITION: SHELL: 100% Wool (merino), LINING: 71% Polyester 29% Wool (merino)
FIT: Athletic
SIZE: One size
ECO-FEATURES: - Re-source product - Mulesing-free Merino Wool

SCOTT CORDUROY CAP 412775



COMPOSITION: SHELL: 100% Cotton
SIZE: One size
FIT: Regular

SCOTT MERINO NECK GAITER (PACK 3) 419404



TECHNOLOGIES: Merino Wool
COMPOSITION: 100% Wool (merino)
FIT: Regular
SIZE: One size
ECO-FEATURES: - Re-source product - Mulesing-free Merino Wool

SCOTT LT NECK GAITER 408973



TECHNOLOGIES: DUROxpend, DRYOxcell
COMPOSITION: 100% Polyester (recycled)
SIZE: One size
APPROX. WEIGHT: 35g
FEATURES: - Multifunctional - Quick-dry - Breathable - Fully seamless
ECO-FEATURES: - Re-source product

SCOTT MTN 10 WOMEN'S BEANIE (PACK 3)

419407



COMPOSITION: SHELL: 40% Acrylic 30% Polyester (recycled) 30% Polyester
FIT: Regular
SIZE: One size

ECO-FEATURES:
 • Recycled content

SCOTT MTN 20 WOMEN'S BEANIE (PACK 3)

419408



TECHNOLOGIES: Merino Wool
COMPOSITION: SHELL: 35% Polyester (recycled) 35% Polyester 30% Wool (merino)
FIT: Regular

SIZE: One size
ECO-FEATURES:
 • Recycled content

SCOTT MTN 20 MEN'S BEANIE (PACK 3)

419438



TECHNOLOGIES: Merino Wool
COMPOSITION: SHELL: 35% Polyester (recycled) 35% Polyester 30% Wool (merino)
FIT: Regular

SIZE: One size
ECO-FEATURES:
 • Recycled content

SCOTT TEAM 10 BEANIE (PACK 3)

272306



COMPOSITION: SHELL: 40% Acrylic 30% Polyester (recycled) 30% Polyester
FIT: Regular

SIZE: One size
ECO-FEATURES:
 • Recycled content

SCOTT MTN 30 WOMEN'S BEANIE (PACK 3)

283683



COMPOSITION: SHELL: 40% Acrylic 30% Polyester (recycled) 30% Polyester
FIT: Regular
SIZE: One size

ECO-FEATURES:
 • Recycled content

SCOTT MTN 40 WOMEN'S BEANIE (PACK 3)

283685



COMPOSITION: SHELL: 100% Acrylic
FIT: Regular

SIZE: One size

SCOTT TEAM 20 MERINO BEANIE (PACK 3)

291996



TECHNOLOGIES: Merino Wool
COMPOSITION: SHELL: 35% Polyester (recycled) 35% Polyester 30% Wool (merino)
FIT: Regular

SIZE: One size
ECO-FEATURES:
 • Recycled content

SCOTT TEAM 30 BEANIE (PACK 3)

419433



COMPOSITION: SHELL: 40% Acrylic 30% Polyester (recycled) 30% Polyester
FIT: Regular

SIZE: One size

SCOTT MTN 10 MEN'S BEANIE (PACK 3)

419409



COMPOSITION: SHELL: 40% Acrylic 30% Polyester (recycled) 30% Polyester
FIT: Regular
SIZE: One size

ECO-FEATURES:
 • Recycled content

SCOTT TEAM 40 BEANIE (PACK 3)

419435



COMPOSITION: SHELL: 39% Acrylic 28% Polyester (recycled) 28% Polyester 5% Elastane
FIT: Regular

SIZE: One size

SCOTT TEAM JUNIOR BEANIE (PACK 3)

272314



COMPOSITION: SHELL: 40% Acrylic 30% Polyester (recycled) 30% Polyester
FIT: Regular
SIZE: One size

ECO-FEATURES:
 • Recycled content

LIFESTYLE





MEN'S
LIFESTYLE



mellow yellow

SCOTT TECH PARKA MEN'S JACKET

400114



The Tech parka is fully equipped for your everyday winter activities. Its clean design, long fit and warm insulation make it comfortable and stylish. This is our most versatile jacket, whether you're in the city or the mountains.

TECHNOLOGIES: DRYOsphere 2L, DUROloft ECO
COMPOSITION: SHELL: 100% Polyester (recycled), LINING: 100% Polyester (recycled), PADDING: 100% Polyester (recycled)
INSULATION: DUROloft ECO
FIT: Athletic
APPROX. WEIGHT (KG): 1000g
SIZE: S-XXL

WATERPROOFNESS: 10.000 mm (JIS L1092 B)
BREATHABILITY: 10.000 g/m2/24hrs (JIS L 1099 B1-inverted cup)
FEATURES:
• Hand & chest pockets
• Security zipped interior pocket
• Knit cuffs
• 3D molded SCOTT icon on sleeve
• YKK Vision® Aquaguard® 2-way zip
ECO-FEATURES:
• Re-source product
• Recycled content
• PFC-Free DWR



dark grey



fir green

SCOTT TECH WARM MEN'S COAT



A long, insulated coat for an active lifestyle. The DUROloft ECO insulation offers the perfect balance between warmth and weight. Made light enough for everyday use, yet warm enough for when the temperature drops. To keep fleeting snowfall out, this jacket is made with a DRYOsphere 2L waterproof outer material.



black



back



fir green

TECHNOLOGIES: DRYOsphere 2L, DUROloft ECO
COMPOSITION: SHELL: 100% Polyester (recycled), LINING: 100% Polyester (recycled), FILL: 100% Polyester (recycled)
FIT: Regular
APPROX. WEIGHT (KG): 700g
SIZE: S-XXL

WATERPROOFNESS: 15.000 mm (JIS L1092 B)
BREATHABILITY: 10.000 g/m2/24hrs (JIS L 1099 B1-inverted cup)
FEATURES:
• Hand pockets
• Adjustable hood
• 3D molded SCOTT icon on sleeve
ECO-FEATURES:
• Re-source product
• Recycled content
• PFC-Free DWR

SCOTT TECH INFINIUM MEN'S JACKET

400115



The Infinium Tech jacket is a must-have for the winter. Urban inspired for the city, but warm and boasting technical features for in-resort use. Recycled insulation keeps you cozy while the removable hood creates a versatile look.



dark blue



back



fir green

TECHNOLOGIES: GORE-TEX INFINIUM™ garments with WINDSTOPPER® product technology, DUROloft ECO
COMPOSITION: SHELL: 100% Polyester (recycled), LINING: 100% Polyester (recycled), PADDING: 100% Polyester (recycled)
INSULATION: DUROloft ECO
FIT: Athletic
APPROX. WEIGHT (KG): 900g
SIZE: S-XXL

FEATURES:
• Hand pockets
• Security zipped interior pocket
• Adjustable hem
• Elastic binding at cuffs
• 3D molded SCOTT icon on sleeve
ECO-FEATURES:
• Re-source product
• Recycled content
• PFC-Free DWR

SCOTT TECH BOMBER MEN'S JACKET

400112



The Tech Bomber jacket is an everyday piece. Worn as a standalone jacket during the warmer seasons or as a layer in winter, thanks to its light weight and packability, the bomber provides style and warmth.



dark grey



back



dark blue



fir green

TECHNOLOGIES: DUROloft ECO, Toray Airtastic™
COMPOSITION: SHELL: 100% Polyamide, COATING: 100% Polyurethane, LINING: 100% Polyester (recycled), PADDING: 100% Polyester (recycled)
INSULATION: 60g DUROloft ECO
FIT: Athletic
APPROX. WEIGHT (KG): 350g
SIZE: S-XXL

FEATURES:
• Hand pockets
• Stretch knit cuffs and collar
• Packable
• Lightweight
• 3D molded SCOTT icon on sleeve
ECO-FEATURES:
• Re-source product
• Recycled content
• PFC-Free DWR

SCOTT DEFINED WARM HYBRID MEN'S HOODY

411101



The warmest fleece of the line combines the best of both worlds: windproof and insulated in the front, with soft fleece on the sleeves and back. Stretchable, warm, and breathable, this piece is a must-have on the slopes.



black



back



fir green



savanna green

TECHNOLOGIES: DUROloft ECO

COMPOSITION: SHELL: 91% Polyester (recycled) 9% Lyocell, SHELL 2: 86% Polyamide 14% Elastane, FILL: 100% Polyester (recycled)

INSULATION: DUROloft ECO insulation

FIT: Regular

APPROX. WEIGHT (KG): 460g

SIZE: S-XXL

FEATURES:

- Zipped hand pockets
- Elastic bottom hem and cuffs
- Seamless baffle construction
- Hybrid construction

ECO-FEATURES:

- Re-source product
- Recycled content
- PFC-Free DWR

SCOTT DEFINED MID MEN'S HOODY

291812



The Defined Mid hoody is a lifestyle yet technical hoody. Sporty, it is the kind of layer you will use for any activity in the resorts.



black



back



light grey



dark blue/fir green



northern mint green/aruba green

TECHNOLOGIES: Brushed fleece knit

COMPOSITION: 63% Polyester (recycled) 37% Polyester

FIT: Athletic

APPROX. WEIGHT (KG): 350g

SIZE: XS-XXL

FEATURES:

- Zipped hand pockets
- Stretch

ECO-FEATURES:

- Re-source product
- Recycled content

SCOTT DEFINED MID MEN'S PULLOVER HOODY

294674



The Defined Mid hoody is a lifestyle yet technical hoody. Sporty, it is the kind of layer you will use for any activity in the resorts.



black



back



aruba green



fir green



dust white

TECHNOLOGIES: Brushed fleece knit

COMPOSITION: 63% Polyester (recycled) 37% Polyester

FIT: Athletic

APPROX. WEIGHT (KG): 350g

SIZE: XS-XXL

FEATURES:

- Zipped hand pockets
- Adjustable hood
- Stretch

ECO-FEATURES:

- Re-source product
- Recycled content

SCOTT TECH WARM ZIP MEN'S HOODY

This semi-technical, everyday hoody is a perfect winter essential. Made with a stretch, cozy, brushed fabric to keep you warm throughout the day.



dark blue



back



grey melange



fir green



dust grey

COMPOSITION: SHELL: 80% Cotton 20% Polyester

FIT: Regular

APPROX. WEIGHT (KG): 300g

SIZE: S-XXL

FEATURES:

- Full front opening with zipper
- Hand pockets
- Adjustable hood
- 3D molded SCOTT icon on chest

SCOTT TECH WARM MEN'S HOODY

410890

This semi-technical, everyday hoody is a perfect winter essential. Made with a stretch, cozy, brushed fabric to keep you warm throughout the day.



dark blue



back



grey melange



winter green



dust grey

COMPOSITION: SHELL: 80% Cotton 20% Polyester

FIT: Regular

APPROX. WEIGHT (KG): 300g

SIZE: S-XXL

FEATURES:

- Hand pockets
- Adjustable hood

SCOTT TECH JOGGER WARM MEN'S PANTS

412109

These semi-technical, everyday jogger pants are a perfect winter essential. Made with a stretch, cozy, brushed fabric to keep you warm throughout the day.



dark blue



back



grey melange



fir green

COMPOSITION: SHELL: 80% Cotton 20% Polyester

FIT: Regular

APPROX. WEIGHT (KG): 350 g

SIZE: S-XXL

FEATURES:

- Hand pockets

SCOTT TECH WARM WOMEN'S COAT



A long, insulated coat for an active lifestyle. The DUROloft ECO insulation offers the perfect balance between warmth and weight. Made light enough for everyday use, yet warm enough for when the temperature drops. To keep fleeting snowfall out, this jacket is made with a DRYOsphere 2L waterproof outer material.



back



fir green



wild red



dust grey

TECHNOLOGIES: DRYOsphere 2L, DUROloft ECO

COMPOSITION: SHELL: 100% Polyester (recycled), LINING: 100% Polyester (recycled), FILL: 100% Polyester (recycled)

FIT: Regular

APPROX. WEIGHT (KG): 700g

SIZE: EU XS-EU XL

WATERPROOFNESS: 15.000 mm (JIS L1092 B)

BREATHABILITY: 10.000 g/m2/24hrs (JIS L 1099 B1-inverted cup)

FEATURES:

- Hand pockets
- Adjustable hood
- 3D molded SCOTT icon on sleeve

ECO-FEATURES:

- Re-source product
- Recycled content
- PFC-Free DWR

SCOTT TECH INFINIUM WOMEN'S JACKET

400121



The Infinium Tech jacket is a must-have for the winter. Urban inspired for the city, but warm and boasting technical features for in-resort use. Recycled insulation keeps you cosy while the removable hood creates a versatile look.



back



fir green

TECHNOLOGIES: GORE-TEX INFINIUM™ garments with WINDSTOPPER® product technology, DUROloft ECO

COMPOSITION: SHELL: 100% Polyester (recycled), LINING: 100% Polyester (recycled), PADDING: 100% Polyester (recycled)

FIT: Athletic

APPROX. WEIGHT (KG): 900g

SIZE: EU XS-EU XL

FEATURES:

- Hand pockets
- Security zipped interior pocket
- Elastic binding at cuffs
- 3D molded SCOTT icon on sleeve

ECO-FEATURES:

- Re-source product
- Recycled content
- PFC-Free DWR

WOMEN'S LIFESTYLE



black

SCOTT TECH PARKA WOMEN'S JACKET

400120



The Tech parka is fully equipped for your everyday winter activities. Its clean design, long fit and warm insulation make it comfortable and stylish. This is our most versatile jacket, whether you're in the city or the mountains.



fir green

TECHNOLOGIES: DRYOsphere 2L, DUROloft ECO

COMPOSITION: SHELL: 100% Polyester (recycled), LINING: 100% Polyester (recycled), PADDING: 100% Polyester (recycled)

FIT: Athletic

APPROX. WEIGHT (KG): 1000g

SIZE: EU XS-EU XL

WATERPROOFNESS: 10.000 mm (JIS L1092 B)

BREATHABILITY: 10.000 g/m2/24hrs (JIS L 1099 B1-inverted cup)

FEATURES:

- Hand & chest pockets
- Security zipped interior pocket
- Knit cuffs
- 3D molded SCOTT icon on sleeve
- YKK Vislon® Aquaguard® 2-way zip

ECO-FEATURES:

- Re-source product
- Recycled content
- PFC-Free DWR

SCOTT TECH BOMBER WOMEN'S JACKET

400122



The Tech Bomber jacket is an everyday piece. Worn as a standalone jacket during the warmer seasons or as a layer in winter, thanks to its light weight and packability, the bomber provides style and warmth.



dark blue



back



glace blue

TECHNOLOGIES: DUROloft ECO, Toray Airtastic™
COMPOSITION: SHELL: 100% Polyamide, COATING: 100% Polyurethane, LINING: 100% Polyester (recycled), PADDING: 100% Polyester (recycled)
FIT: Athletic
APPROX. WEIGHT (KG): 350g
SIZE: EU XS-EU XL

FEATURES:
 • Hand pockets
 • Stretch knit cuffs and collar
 • Packable
 • Lightweight
 • 3D molded SCOTT icon on sleeve
ECO-FEATURES:
 • Re-source product
 • Recycled content
 • PFC-Free DWR

SCOTT TECH WARM ZIP WOMEN'S HOODY

This semi-technical, everyday hoody is a perfect winter essential. Made with a stretch, cozy, brushed fabric to keep you warm throughout the day.



dark blue



back



grey melange



northern mint green



dust white



wild red

COMPOSITION: SHELL: 80% Cotton 20% Polyester
FIT: Regular
APPROX. WEIGHT (KG): 350g
SIZE: EU XS-EU XL

FEATURES:
 • Full front opening with zipper
 • Hand pockets
 • Adjustable hood
 • 3D molded SCOTT icon on chest

SCOTT DEFINED WARM HYBRID WOMEN'S HOODY

411103



The warmest fleece of the line combines the best of both worlds: windproof and insulated in the front, with soft fleece on the sleeves and back. Stretchable, warm, and breathable, this piece is a must-have on the slopes.



black



back



dark blue



cloud pink

TECHNOLOGIES: DUROloft ECO
COMPOSITION: SHELL: 91% Polyester (recycled) 9% Lyocell, SHELL 2: 86% Polyamide 14% Elastane, FILL: 100% Polyester (recycled)
INSULATION: DUROloft ECO insulation
FIT: Regular
APPROX. WEIGHT (KG): 420g
SIZE: EU XS-EU XL

FEATURES:
 • Zipped hand pockets
 • Seamless baffle construction
 • Hybrid construction
ECO-FEATURES:
 • Re-source product
 • Recycled content
 • PFC-Free DWR

SCOTT TECH WARM WOMEN'S HOODY

410892

This semi-technical, everyday hoody is a perfect winter essential. Made with a stretch, cozy, brushed fabric to keep you warm throughout the day.



dark blue



back



grey melange



dust white



heather purple



wild red

COMPOSITION: SHELL: 80% Cotton 20% Polyester
FIT: Regular
APPROX. WEIGHT (KG): 350g
SIZE: EU XS-EU XL

FEATURES:
 • Hand pockets
 • Adjustable hood

SCOTT DEFINED HERITAGE PILE WOMEN'S JACKET

411129



The Defined Heritage pile fleece jacket gives you that retro look. Featuring a warm pile fleece knitted fabric, this is definitely an everyday essential.



black



back



fir green



dust white

TECHNOLOGIES: Pile fleece knit
COMPOSITION: 100% Polyester
FIT: Regular
APPROX. WEIGHT (KG): 530g
SIZE: EU XS-EU XL

FEATURES:
 • Zipped hand pockets
 • Elastic bottom hem and cuffs
ECO-FEATURES:
 • Recycled content
 • PFC-Free DWR

SCOTT TECH JOGGER WARM WOMEN'S PANTS

412110

These semi-technical, everyday jogger pants are a perfect winter essential. Made with a stretch, cozy, brushed fabric to keep you warm throughout the day.



dark blue



back



grey melange



heather purple

COMPOSITION: SHELL: 80% Cotton 20% Polyester
FIT: Regular
APPROX. WEIGHT (KG): 350g
SIZE: EU XS-EU XL

FEATURES:
 • Hand pockets